

TACTICAL EMPLOYMENT OF ANTIARMOR PLATOONS AND COMPANIES



HEADQUARTERS
DEPARTMENT OF THE ARMY

NOVEMBER 2002

TACTICAL EMPLOYMENT OF ANTIARMOR PLATOONS AND COMPANIES

CONTENTS

	Page
PREFACE	viii
CHAPTER 1. INRODUCTION	
1-1. Antiarmor Doctrine.....	1-1
1-2. Organization and Characteristics	1-1
1-3. Fundamentals of Antiarmor Unit Employment	1-4
1-4. Capabilities and Limitations	1-9
1-5. Enemy Antiarmor Countermeasures.....	1-10
CHAPTER 2. BATTLE COMMAND AND TROOP-LEADING PROCEDURES	
Section I. Command and Control.....	2-1
2-1. Definition of Command and Control	2-1
2-2. Concept of Command and Control	2-2
2-3. Leadership.....	2-2
2-4. Fundamentals of Command and Control	2-2
2-5. Command and Control Responsibilities	2-3
2-6. Combat Orders.....	2-4
Section II. Troop-Leading Procedures	2-5
2-7. Application of Troop-Leading Procedures	2-5
2-8. Receive the Mission.....	2-7
2-9. Issue a Warning Order	2-22
2-10. Make a Tentative Plan	2-22
2-11. Initiate Movement.....	2-26
2-12. Conduct Reconnaissance	2-27
2-13. Complete the Plan.....	2-27
2-13. Issue the OPORD.....	2-27
2-15. Supervise and or Refine.....	2-28

DISTRIBUTION RESTRICTION: Approved for public release; distribution is unlimited.

*This publication supersedes FM 7-91, 30 September 1987.

		Page
CHAPTER 3. MOVEMENT		
	3-1.	Movement Fundamentals..... 3-1
	3-2.	Movement Formations..... 3-2
	3-3.	Movement Techniques..... 3-9
CHAPTER 4. OFFENSIVE OPERATIONS		
Section	I.	General Planning Considerations..... 4-1
	4-1.	Purpose of the Offense..... 4-1
	4-2.	Characteristics of the Offense..... 4-1
	4-3.	Consideration of Selected Battlefield Operating Systems..... 4-2
	4-4.	Sequence of Offensive Operations 4-4
	4-5.	Forms of Maneuver..... 4-5
Section	II.	Maneuver 4-9
	4-6.	Base-of-Fire Force 4-9
	4-7.	Bounding Force..... 4-9
Section	III.	Actions on Contact..... 4-10
	4-8.	Developing Actions on Contact..... 4-11
	4-9.	Time Requirements for Actions on Contact 4-11
	4-10.	The Four Steps of Actions on Contact..... 4-11
Section	IV	Types of Offensive Operations 4-14
	4-11.	Attack Characteristics 4-14
	4-12.	Hasty and Deliberate Attacks 4-15
	4-13.	Attack Options 4-18
	4-14.	Movement to Contact..... 4-21
	4-15.	Exploitation..... 4-30
	4-16.	Pursuit 4-30
CHAPTER 5. DEFENSIVE OPERATIONS		
Section	I.	General Planning Considerations..... 5-1
	5-1.	Purpose of the Defense 5-1
	5-2.	Characteristics of the Defense 5-1
Section	II.	Sequence of the Defense..... 5-3
	5-3.	Reconnaissance and Security Operations, and Enemy Preparatory Fires..... 5-3
	5-4.	Occupation and Preparation..... 5-3
	5-5.	Approach of the Enemy Main Attack 5-4
	5-6.	Enemy Assault 5-4
	5-7.	Counterattack 5-4
	5-8.	Consolidation and Reorganization..... 5-4
Section	III.	BOS Planning Considerations 5-4
	5-9.	Maneuver 5-5
	5-10.	Fire Support 5-7
	5-11.	Air Defense 5-7
	5-12.	Mobility, Countermobility, and Survivability 5-8
	5-13.	Combat Service Support 5-11

		Page
Section	IV. Preparation and Integration.....	5-12
	5-14. Defensive Techniques.....	5-12
	5-15. Other Defensive Employment Options.....	5-22
	5-16. Engagement Area Development	5-25
	5-17. Priority of Work.....	5-32
	5-18. Sector Sketches	5-34
	5-19. Adjacent Unit Coordination.....	5-35
 CHAPTER 6. URBAN OPERATIONS		
Section	I. General Planning Considerations.....	6-1
	6-1. Employment Considerations for Company-Size Combined-Arms Teams	6-1
	6-2. Employment of Antiarmor Vehicles.....	6-2
Section	II. Offense.....	6-7
	6-3. General Offensive Considerations	6-7
	6-4. METT-TC Factors	6-8
	6-5. Battle Command	6-10
	6-6. Movement	6-13
	6-7. Isolate an Urban Objective	6-14
	6-8. Attack a Block or Group of Buildings	6-16
	6-9. Consolidation and Reorganization.....	6-16
Section	III. Defense	6-17
	6-10. METT-TC Factors	6-17
	6-11. Command and Control.....	6-25
	6-12. Hasty Defense	6-26
	6-13. Company Defense of a Village.....	6-27
	6-14. Defense of a Block or Group of Buildings	6-28
	6-15. Defense of Key Terrain.....	6-29
 CHAPTER 7. TACTICAL ENABLING OPERATIONS		
Section	I. Reconnaissance.....	7-1
	7-1. Reconnaissance Planning.....	7-1
	7-2. Reconnaissance Execution.....	7-1
	7-3. Reconnaissance during Operations	7-1
	7-4. Forms of Reconnaissance	7-1
Section	II. Security Operations.....	7-2
	7-5. Forms of Security Operations	7-3
	7-6. Planning Considerations	7-3
	7-7. Screen.....	7-6
	7-8. Guard.....	7-8
	7-9. Local Security	7-11
Section	III. Linkup	7-12
	7-10. Linkup Situations.....	7-12
	7-11. Linkup Planning.....	7-12
	7-12. Steps of the Linkup Operation	7-13

		Page
Section	IV. Passage of Lines.....	7-14
	7-13. Planning Considerations	7-15
	7-14. Reconnaissance Coordination.....	7-15
	7-15. Forward Passage of Lines	7-16
	7-16. Rearward Passage of Lines	7-17
CHAPTER 8. STABILITY OPERATIONS		
Section	I. Principles of Stability Operations	8-1
	8-1. Objective.....	8-1
	8-2. Unity of Effort	8-2
	8-3. Security	8-2
	8-4. Restraint.....	8-2
	8-5. Perseverance	8-2
	8-6. Legitimacy	8-3
Section	II. Types of Stability Operations	8-3
	8-7. Peace Operations.....	8-3
	8-8. Foreign Internal Defense	8-4
	8-9. Security Assistance.....	8-5
	8-10. Humanitarian and Civic Assistance.....	8-5
	8-11. Support to Insurgencies.....	8-5
	8-12. Support to Counterdrug Operations	8-5
	8-13. Combating Terrorism.....	8-5
	8-14. Noncombatant Evacuation Operations	8-6
	8-15. Arms Control	8-7
	8-16. Show of Force Operations	8-7
Section	III. Planning Considerations	8-7
	8-17. Rules of Engagement	8-7
	8-18. Rules of Interaction.....	8-8
	8-19. Force Protection.....	8-8
	8-20. Task Organization.....	8-9
	8-21. CSS Considerations	8-9
	8-22. Media Considerations	8-9
	8-23. Operations with Outside Agencies	8-10
Section	IV. Company Tasks.....	8-10
	8-24. Establish and Occupy a Lodgment Area.....	8-10
	8-25. Negotiations.....	8-13
	8-26. Monitor Compliance with an Agreement	8-15
	8-27. Establish Observation Posts.....	8-15
	8-28. Establish Checkpoints.....	8-16
	8-29. Conduct Patrol Operations.....	8-19
	8-30. Conduct Convoy Escort	8-19
	8-31. Open and Secure Routes	8-24
	8-32. Conduct Reserve Operations	8-24

		Page
CHAPTER 9. SUPPORT OPERATIONS		
Section	I. Types of Support Operations	9-1
	9-1. Domestic Support Operations	9-1
	9-2. Foreign Humanitarian Assistance	9-2
	9-3. Categories of Support Operations	9-2
Section	II. Considerations for Support Operations.....	9-4
	9-4. Provide Essential Support to the Largest Number of People....	9-4
	9-5. Coordinate Actions with Other Agencies	9-4
	9-6. Establish Measures of Effectiveness.....	9-5
	9-7. Handover to Civilian Agencies as soon as Feasible	9-5
	9-8. Transition to Combat	9-5
Section	III. Phases of Support Operations	9-5
	9-9. Response Phase.....	9-6
	9-10. Recovery Phase.....	9-6
	9-11. Restoration Phase.....	9-6
CHAPTER 10. COMBAT SUPPORT		
Section	I. Command and Support Relationships	10-1
	10-1. Command Relationships	10-1
	10-2. Support Relationships	10-1
Section	II. Fire Support	10-2
	10-3. Fire Support Considerations	10-2
	10-4. Fire Support Planning	10-4
	10-5. Maneuver Commander's Intent	10-10
	10-6. Planning Process	10-10
	10-7. Targets	10-13
	10-8. Final Protective Fires	10-14
	10-9. Special Munitions	10-15
	10-10. Observer Positions	10-15
	10-11. Rehearsal and Execution.....	10-16
	10-12. Communications	10-17
	10-13. Indirect Fires in Close Support	10-17
	10-14. Fire Support Team	10-18
	10-15. Close Air Support	10-18
	10-16. Attack Helicopters	10-21
Section	III. Intelligence.....	10-22
	10-17. Intelligence Assets	10-22
	10-18. Intelligence Considerations.....	10-23
Section	IV. Maneuver Support.....	10-23
	10-19. Engineers	10-23
	10-20. Mobility	10-23
	10-21. Countermobility.....	10-24
	10-22. Survivability.....	10-30
	10-23. NBC Support.....	10-30
Section	V. Air Defense Artillery	10-31

		Page
	10-24. Systems, Organization, and Capabilities	10-31
	10-25. Employment of Air Defense Systems.....	10-33
	10-26. Weapons Control Status	10-33
	10-27. Early Warning Procedures	10-33
	10-28. Reaction Procedures	10-34
Section	VI. Combat Support in The Stryker brigade combat team	10-36
	10-29. SBCT	10-36
	10-30. Infantry Battalion.....	10-36

CHAPTER 11. COMBAT SERVICE SUPORT OPERATIONS

Section	I. Airborne, Air Assault, and Light Infantry Battalion CSS	11-1
	11-1. Development of the CSS Plan	11-1
	11-2. General Guidelines	11-1
	11-3. Responsibilities.....	11-2
Section	II. Trains	11-4
	11-4. Battalion Combat Trains.....	11-4
	11-5. Battalion Field Trains	11-4
	11-6. Company Trains.....	11-4
	11-7. Trains Security.....	11-5
	11-8. Communications	11-5
Section	III. Resupply Operations.....	11-5
	11-9. Classes of Supply.....	11-5
	11-10. Routine Resupply.....	11-7
	11-11. Emergency Resupply	11-10
	11-12. Prestock Operations	11-10
	11-13. Antiarmor Company Resupply Requirements.....	11-11
Section	IV. Maintenance Operations	11-11
	11-14. Requirements	11-11
	11-15. Company Role in Maintenance Operations	11-12
	11-16. Destruction.....	11-13
Section	V Health Service Support	11-13
	11-17. Health and Hygiene	11-13
	11-18. Soldiers Wounded in Action.....	11-13
	11-19. Soldiers Killed in Action	11-15
	11-20. Casualty Evacuation	11-15
Section	VI. Reorganization and Weapons Replacement	11-18
	11-21. Replacement and Cross-Leveling of Personnel	11-18
	11-22. Personnel Replacement Procedures	11-19
	11-23. Replacement and Salvaging of Equipment.....	11-19
	11-24. Weapon System Replacement Operations.....	11-19
Section	VII. Combat Service Support in the SBCT	11-19
	11-25. SBCT Support Methods.....	11-19
	11-26. Fixing the Force	11-20
	11-27. Arming the Force	11-21
	11-28. Moving the Force.....	11-21

	Page
11-29. Sustaining the Force.....	11-21
11-30. Manning the Force.....	11-22
11-31. Responsibility of Company Personnel.....	11-22
APPENDIX A. WEAPON REFERENCE DATA	A-1
APPENDIX B. RISK MANAGEMENT AND FRATRICIDE AVOIDANCE.....	B-1
APPENDIX C. DIRECT FIRE PLANNING AND CONTROL	C-1
APPENDIX D. FIRING POSITIONS	D-1
APPENDIX E. TOW EMPLOYMENT IN RESTRICTIVE TERRAIN.....	E-1
GLOSSARY	Glossary-1
REFERENCES.....	References-1
INDEX	Index-1

PREFACE

This manual is based on the premise that although the unit organization, weapons systems, and conditions have changed, antiarmor company and platoon maneuver, fire, and movement have not changed.

FM 3-21.91 (FM 7-91) provides doctrine for employing the antiarmor company and platoon. It contains guidance on tactics and techniques that antiarmor companies and platoons use in offensive, defensive, stability, and support operations.

This manual borrows from “nested” concepts found in FM 7-10 and FM 71-1 and reemphasizes information from other manuals that are of critical importance. The target audience includes antiarmor platoon leaders, company and battalion commanders, and battalion staff officers. This manual provides training developers with the combat-critical tasks and missions of antiarmor companies and platoons, and it enables combat developers to refine and revise operational concepts for antiarmor organizations.

The proponent of this publication is the US Army Infantry School. Send comments and recommendations to doctrine@benning.army.mil or on DA Form 2028 directly to Commandant, US Army Infantry School, ATTN: ATSH-ATD, Fort Benning, Georgia 31905-5000.

Unless this manual states otherwise, masculine nouns and pronouns do not refer exclusively to men.

CHAPTER 1

THE ROLE OF ANTIARMOR ORGANIZATIONS

Antiarmor companies and platoons can fight and win engagements within the full spectrum of operations (offense, defense, stability, and support). The antiarmor company is normally task organized by the airborne/air assault infantry battalion commander or the Stryker brigade combat team (SBCT) commander, based on his estimate of the situation, to perform a variety of tactical missions as part of battalion or SBCT operations. The light infantry battalion commander task organizes his antiarmor platoon in much the same manner. In filling this combat role, the antiarmor unit integrates with combat, combat support (CS), and combat service support (CSS) elements. The company and platoons are capable of deploying as part of the Army's force projection requirements. This chapter addresses antiarmor doctrine, organization, fundamentals, and capabilities and limitations.

1-1. ANTIARMOR DOCTRINE

Antiarmor systems operate on the battlefield with infantry, armor, and other elements of the combined-arms team as well as with the SBCT. Long-range antiarmor fires are important to destroying the integrity of the enemy's combined-arms team. US tactical doctrine prefers to use a base-of-fire force or a fixing force along with a maneuver force. A commander's situational understanding (SU) will allow units to effectively find and fix the enemy force while maintaining sufficient combat power for decisive maneuver and sufficient depth to reduce the risk and exploit success. Mass and depth are the keys to employing antiarmor assets. When terrain and fields of fire allow, an antiarmor commander (or platoon leader) should control antiarmor subordinate units, planning and directing antiarmor fires in accordance with the higher commander's scheme of maneuver. During tactical operations, antiarmor units suppress, fix, or destroy enemy at long ranges, allowing infantry forces to maneuver. Commanders should task organize and employ antiarmor units based on an analysis of the factors of mission, enemy, terrain, troops and support available, time available, and civil considerations (METT-TC).

1-2. ORGANIZATION AND CHARACTERISTICS

The armor and motorized threat of potential enemies has led to organizing light, airborne, and air assault battalions, and the SBCTs, with antiarmor units. Although they may differ in their organization and equipment, they all have the tube-launched, optically tracked, wire-guided (TOW) weapon system as a centerpiece. In the light, airborne, and air assault battalions, each antiarmor platoon has two sections, and each section has two vehicles. The SBCT antiarmor company consists of three platoons with three TOW-equipped antiarmor interim armored vehicles (ICVs) in each platoon. Table 1-1, page 1-2, depicts the table of organization and equipment (TOE) for antiarmor units.

SIZE ALLOCATED	TYPE OF TOE
Antiarmor Company (5 Platoons)	Infantry (air assault and airborne) battalions
Antiarmor Company (3 Platoons)	Stryker brigade combat team
Antiarmor Platoon	Light infantry battalion

Table 1-1. Antiarmor organization options.

a. **Antiarmor Company in the Airborne and Air Assault Battalion.** Each infantry battalion in the airborne or air assault division has an *assigned antiarmor company* (Figure 1-1). The antiarmor company commander is responsible for advising the battalion commander on the tactical employment of the company and its platoons.

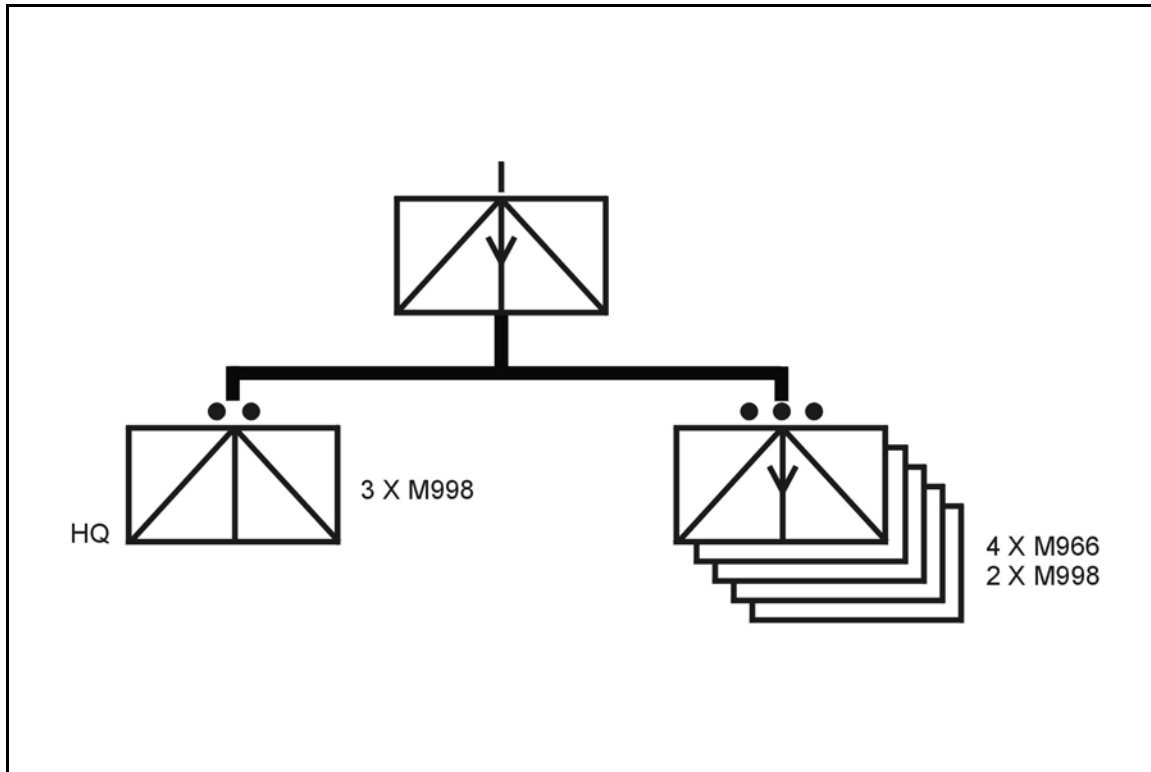

Figure 1-1. Air assault (or airborne) infantry battalion antiarmor company.

b. **Antiarmor Company in the Stryker brigade combat team (SBCT).** Each SBCT has an *assigned antiarmor company* (Figure 1-2). The company commander is responsible for advising the SBCT commander on the tactical employment of the company and its platoons.

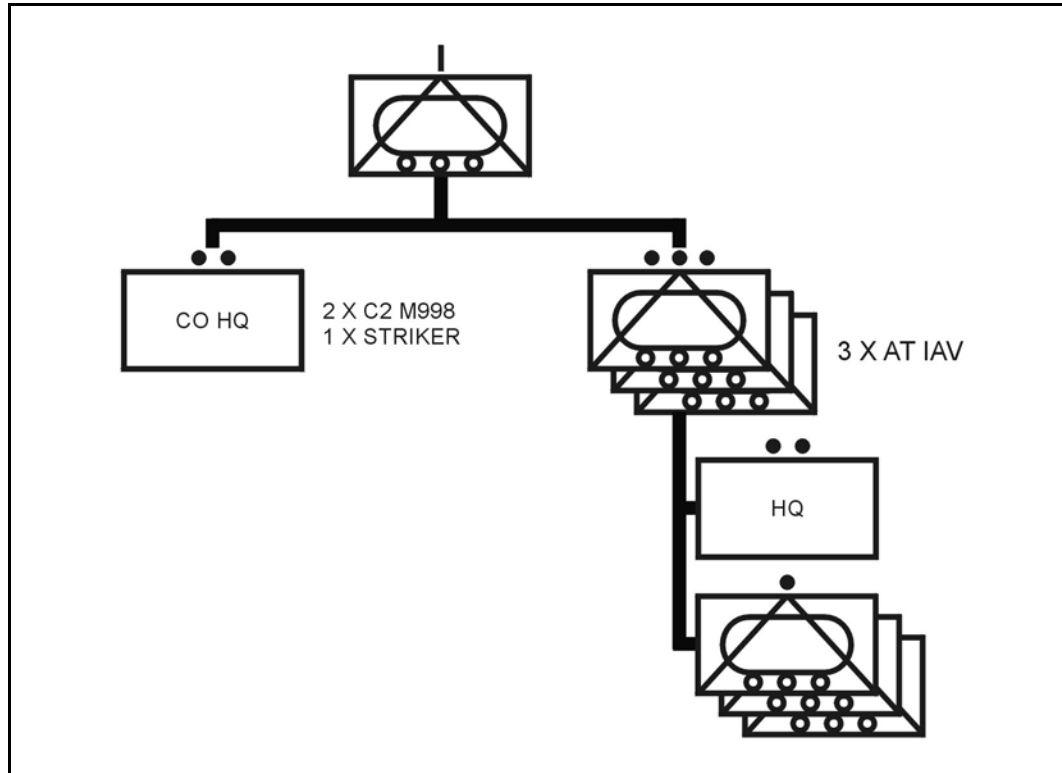

Figure 1-2. Stryker brigade combat team antiarmor company.

c. **Antiarmor Platoon in the Light Infantry Battalion.** In the light infantry division, each infantry battalion has one antiarmor platoon (Figure 1-3, page 1-4). The antiarmor platoon leader is responsible for advising the battalion commander on the tactical employment of the platoon and its sections.

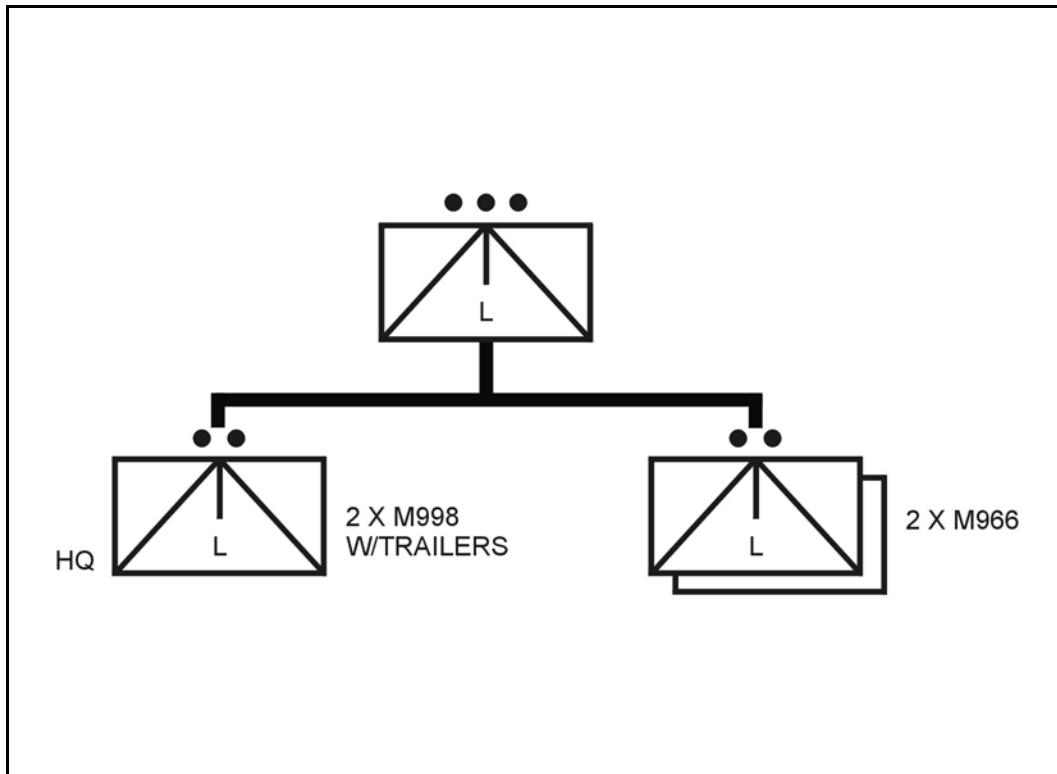

Figure 1-3. Light infantry battalion antiarmor platoon.

1-3. FUNDAMENTALS OF ANTIARMOR UNIT EMPLOYMENT

Following the basic rules of antiarmor employment increases the probability of destroying targets and enhances the survivability of the antiarmor elements.

a. **Mutual Support.** Antiarmor units must support each other due to their assigned tasks, relative positions to each other and to the enemy (obtained via reconnaissance and information sharing), and their inherent capabilities and limitations. To establish mutual support, TOWs are employed in sections with overlapping primary and secondary sectors of fire (Figure 1-4). If one squad is attacked or forced to displace, the other squad continues covering the assigned sector. In order to achieve this effect, the antiarmor squads are positioned so that fires directed at one squad can suppress only that squad. The SBCT antitank platoons' three squads function in the same manner.

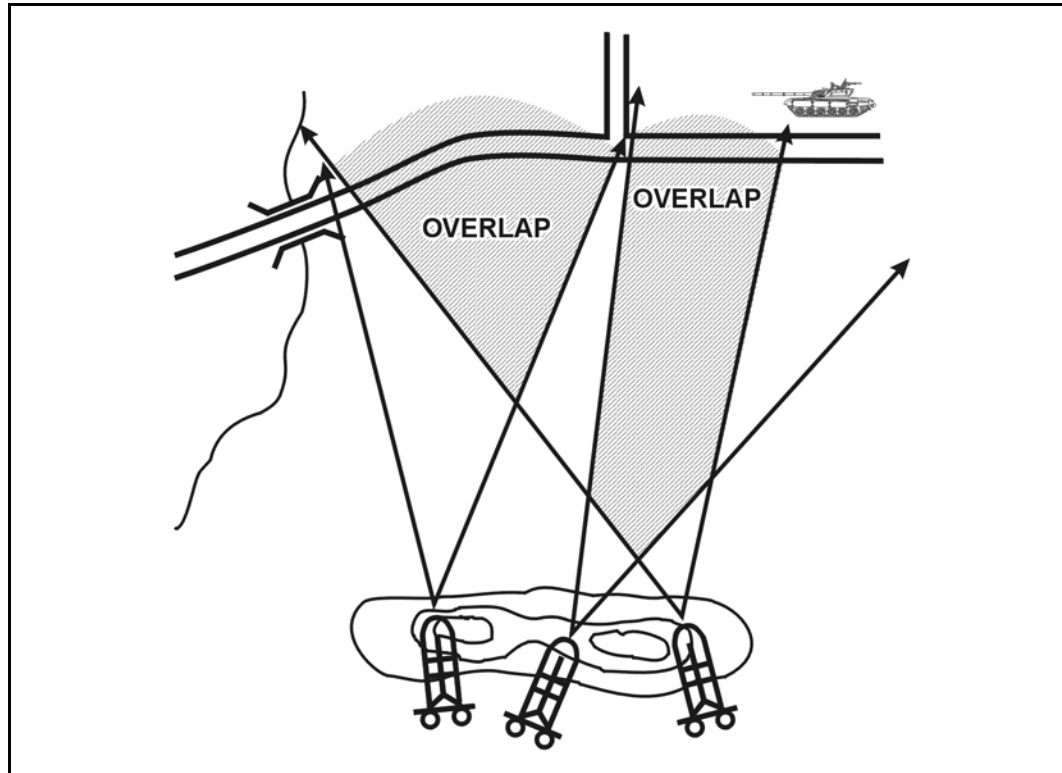

Figure 1-4. Overlapping sectors of fire.

b. **Security.** Antiarmor units must be positioned near friendly infantry units for protection against possible attack by dismounted enemy infantry. Though the infantry units are not required to collocate with antiarmor squads, they should be able to cover dismounted avenues of approach to the antiarmor positions. However, antiarmor units moving with infantry provide their own local security. During halts, the driver or loader dismounts to secure the flank and rear sectors. Overall flank and rear security must be planned at the platoon leader level; if omitted, this lack of protection can be costly. Without flank and rear security during movement, a single enemy vehicle could destroy entire antiarmor squads, sections, or platoons.

c. **Flank Shot Engagements.** Antiarmor squads and sections are positioned to engage tanks or armored vehicles from the flank. Frontal engagements at enemy armor are less desirable for the following reasons:

- (1) An armored vehicle's protection is greatest to the front.
- (2) An armored vehicle's firepower and crew are normally oriented to the front.
- (3) A frontal engagement increases the chance of detection and suppression by enemy armored vehicles.
- (4) An armored vehicle provides a smaller target from the front.

d. **Standoff.** Standoff is the difference between a friendly weapon's maximum range and an enemy weapon's maximum effective range (Figure 1-5, page 1-6). For example, the TOW weapon system's maximum range of 3,750 meters provides it with a standoff advantage over modern, western-built tanks (maximum effective ranges of 2,800 meters) and older, non-modernized tanks (maximum effective ranges of 2,000 meters). Despite this

advantage, engaging enemy armored vehicles within the standoff range (2,000 to 3,750 meters) may not always be tactically feasible. The additional tracking time required to fire a TOW missile beyond 2,000 meters increases the likelihood of gunner error. This possibility gives a frontal target more time to maneuver against the friendly position and provides a flanking target more time to reach cover. Additionally, the terrain may not provide the fields of fire to support standoff distance engagements.

NOTE: The T-55 (modernized), T-64B, T-72S, T-80, T-80U, T-90 main battle tanks, and the BMP-3 can fire anti-tank guided missiles (ATGM) through their main gun tubes up to a range of 4,000 meters, which means the TOW weapon system loses the standoff advantage against them. Some of the tank-launched ATGMs can be fired while the vehicle is on the move. Also, threat armored vehicles can fire high explosive (HE) fragmentation rounds to suppress TOW gunners up to a range of 9,750 meters.

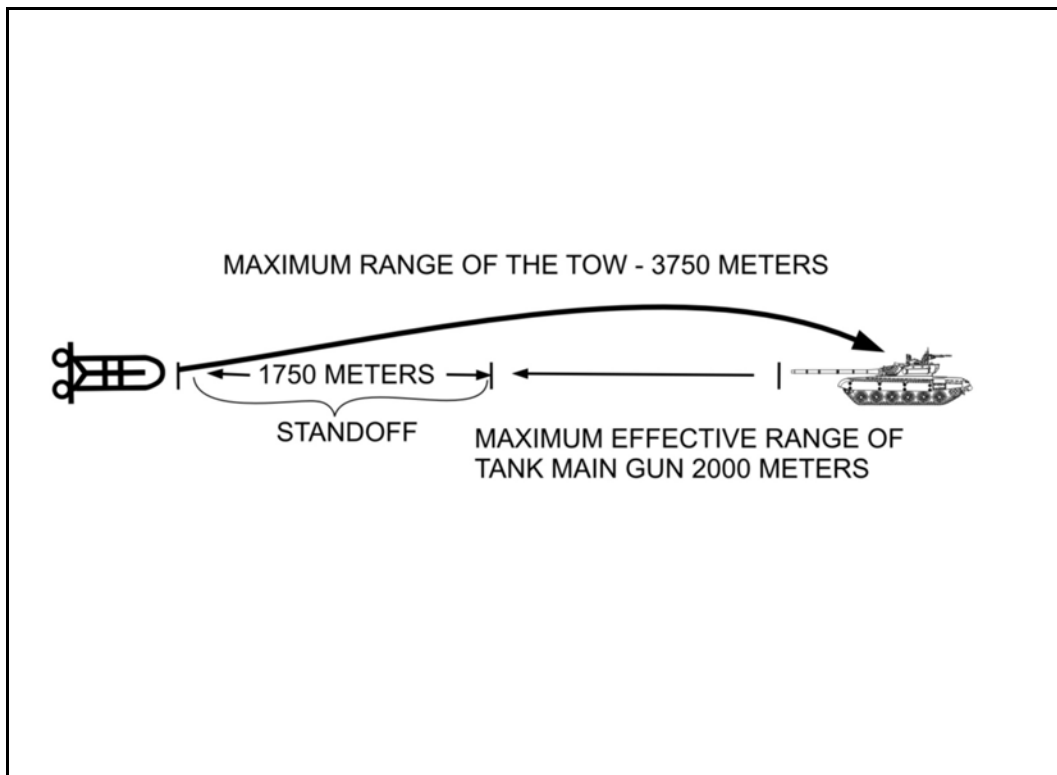

Figure 1-5. Standoff range.

e. Cover and Concealment. Cover and concealment are critical to the survival of antiarmor weapon systems and must be analyzed along with the other factors of METT-TC. An analysis of all of these factors is necessary for the antiarmor unit to be effective, to survive, and to overcome the following inherent weaknesses:

- The gunner is vulnerable because he is exposed while employing the weapon systems (TOW, M2, and MK19).
- The TOW missile and the MK19 40-mm round have a long flight time and a

distinctive firing signature.

- The TOW weapon system has a slow rate of fire and requires time to track.

(1) **Cover.** Cover is protection from the effects of enemy direct or indirect fires. It may be natural or made by man. *Natural cover* includes reverse slopes, ravines, and hollows. *Man-made cover* includes fighting positions, walls, rubble, and craters.

(2) **Concealment.** Concealment is the protection from enemy observation. Night vision devices (NVDs) and other detection devices penetrate darkness and prevent it from providing sufficient concealment. Leaders must choose inconspicuous positions and avoid silhouetting the vehicles or weapon systems against the skyline (“skylining”). The principles of concealment include avoiding unnecessary movement, using all available concealment (such as vegetation, rolling terrain, buildings), staying low to observe, exposing nothing that shines, avoiding “skylining,” altering familiar outlines, and keeping quiet.

(a) *Avoid Unnecessary Movement.* Movement attracts attention. A concealed antiarmor position can be detected if the weapon system is traversed or raised, or if any other unnecessary movement occurs. Moving against a stationary background makes the position stand out.

(b) *Use All Available Concealment.* Background is important. To prevent detection, positions must blend with the varied colors and textures of whatever trees, bushes, grass, earth, or man-made structures form the background. (For example, a TOW weapon system stands out if located in an open area, but it is difficult to see in a wooded area.) An antiarmor weapon system should not be fired from the edge of a wood line but rather from a position inside the wood line hidden by the shape and shade of the trees. Leaders must ensure that the concealment does not interfere with the fields of fire of the weapon systems being employed.

(c) *Stay Low to Observe.* The enemy has difficulty seeing a position with a low silhouette. An antiarmor leader should move forward of his position to observe.

(d) *Expose Nothing That Is Reflective.* The reflection of light on a shiny surface attracts attention and can be seen from a great distance. Optics should be used cautiously in bright sunshine due to the reflections they cause. At night, a night vision device can detect light emitted from the instrument panels inside the vehicles.

(e) *Avoid “Skylining.”* Figures and vehicles on the crests of hills can be seen from a great distance, even at night, since dark outlines stand out against lighter sky.

(f) *Alter Familiar Outlines.* Both military equipment and people provide familiar outlines to the enemy. Camouflage changes the familiar outline.

(g) *Keep Quiet.* Noises, such as talking, idling vehicles, or touching metal to metal, can be heard by enemy patrols or listening posts.

(3) **Considerations.** When employing antiarmor weapon systems, leaders should avoid conspicuous terrain, disperse weapons laterally and in depth so that no single enemy weapon can suppress two antiarmor squads, and disperse antiarmor squads to reduce casualties and equipment damage that could result from enemy mortar and artillery fires (Figure 1-6, page 1-8). The considerations for antiarmor weapon system employment also apply during route selection and movement.

(a) *Offensive Considerations.* Determine the routes where cover and concealment are good, identify areas along the approaches to the objective where cover and concealment are poor, and consider using smoke or conducting missions during limited visibility to provide concealment.

(b) *Defensive Considerations.* Focus on locations with good fields of fire. Determine how the enemy can use the available cover and concealment and look at it from his point of view, both in daylight and at night.

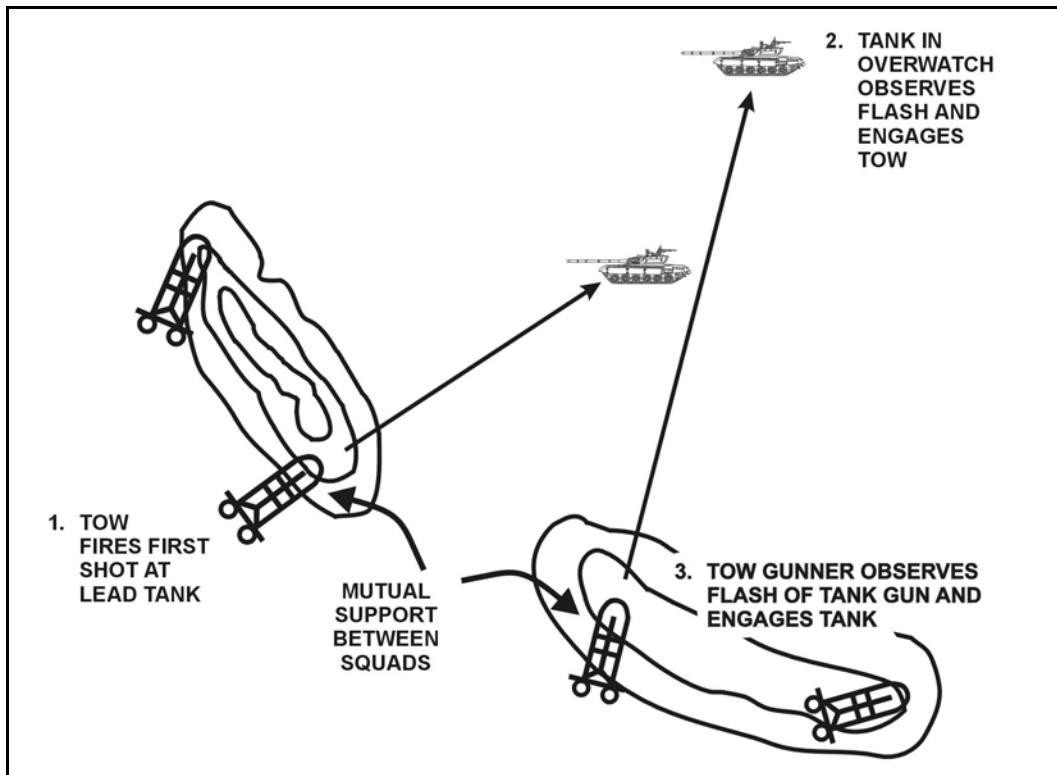

Figure 1-6. Dispersion between squads.

f. **Employment in Depth.** Antiarmor squads should be employed in depth. In the offense, routes and firing positions should be selected to support the forward movement of attacking units. In the defense, antiarmor squads can be positioned forward then moved to positions in depth as the enemy closes, or the squads may be positioned in depth initially.

g. **Employment as Part of a Combined Arms Team.** Skillful integration of infantry, armor, engineer, and indirect fire assets improves the survivability and lethality of antiarmor units.

(1) **Infantry.** Infantry is needed to provide local security and to engage enemy infantry and enemy antiarmor weapon systems. Antiarmor units also support the maneuver of infantry forces.

(2) **Armor.** Antiarmor units support the maneuver of armor forces. Antiarmor units may focus on destroying lightly armored enemy vehicles and dismounted soldiers at long ranges, allowing the tanks to focus on destroying enemy tanks.

(3) **Engineers.** Engineers help shape the battlefield by enhancing mobility, countermobility, and survivability.

(a) Engineers shape the engagement area (EA) for a commander by emplacing tactical obstacles that reduce the enemy's ability to maneuver, mass, or reinforce, and increase his vulnerability to direct and indirect fires. To accomplish this, obstacles must disrupt, fix, turn,

or block the enemy. The engineers emplace the obstacles inside designated obstacle zones, belts, and groups. To be effective, the obstacles must be covered by both direct and indirect fire.

(b) Engineers provide expertise and assistance in breaching operations to allow infantry and armor freedom to maneuver.

(c) Engineers provide assistance in the construction of survivability positions. This assistance is especially important when building vehicle (high mobility, multi-purpose wheeled vehicle [HMMWV] or ICV) fighting positions.

(4) **Indirect Fires.** Antiarmor leaders must be part of the indirect fire planning process at higher levels. They must coordinate frequencies, call signs, and priorities of fire. Antiarmor leaders can request indirect fires. To do this, they must contact the battalion mortar platoon, the battalion fire support element (FSE), a fire support team (FIST), or the direct support (DS) artillery battalion. Indirect fires (artillery and mortars) are used to--

- Destroy or neutralize the enemy.
- Slow the enemy rate of advance.
- Destroy or disrupt enemy formations.
- Cause enemy vehicles to button up.
- Suppress accompanying enemy artillery and ATGM support by fire.
- Fire white phosphorous/hexachloroethane (WP/HC) smoke to conceal weapon system firing signatures and to cover the movement of antiarmor squads between positions.

NOTE: When using obscurants in this manner, antiarmor company commanders (or platoon leaders) must consider the degrading effects these obscurants have on their own weapon systems.

1-4. CAPABILITIES AND LIMITATIONS

The antiarmor weapon systems available (TOW, M2, and MK19) provide direct fire against armored or other hard targets to support maneuver of infantry.

a. **Offensive Capabilities.** An antiarmor unit initially provides the base of fire in an attack in order to suppress, fix, or destroy the enemy in position. The antiarmor unit also can be employed in the offense to engage enemy in planned EAs, to isolate objectives by destroying enemy counterattacks, or by destroying withdrawing enemy forces. The antiarmor unit is also well suited to protect flanks, to fix enemy for destruction by infantry or armor companies, or to repel a counterattack.

b. **Defensive Capabilities.** Antiarmor units can be positioned forward of the defensive sector to participate in security operations or to overwatch reconnaissance units or obstacles. As the enemy closes, the antiarmor unit displaces to positions that provide the direct fires into an EA. Antiarmor units often are positioned throughout the depth of the decisive operation's area of operation to cover likely armor avenues of approach. During counterattacks, the antiarmor unit provides overwatching fires for the maneuvering element.

c. **Additional Capabilities.** Depending on the modified table of organization (MTOE), some infantry antiarmor units can use the HMMWV interchangeable mount systems (HIMS). This system enables the unit to adapt quickly to changes resulting from an analysis of the factors of METT-TC. With the HIMS, the unit can quickly mount the MK19 or the M2 on

the HMMWV to destroy light armored vehicles, field fortifications, and troops. These weapon systems complement other weapon systems, especially the TOW. The M249, 5.56mm squad automatic weapon (SAW), provides the antiarmor unit with an asset that can engage targets (dismounted threat) without revealing its M2 or MK19 in the close fight.

d. **Limitations.** Antiarmor units have limitations that apply to both offensive and defensive situations.

(1) Antiarmor units equipped with HMMWVs must consider that these vehicles lack protection against direct and indirect fires. Although ICV-equipped antiarmor vehicles have greater protection against direct and indirect fires than the HMMWV, they are still vulnerable to enemy antiarmor weapons. The SBCT antiarmor company commander must take these vulnerabilities into considerations.

(2) An antiarmor squad (three soldiers) cannot adequately defend itself when confronted with a dismounted threat for an extended period of time.

(3) TOW missiles are accurate, but missile flight time is long (Appendix A). The slow rate of fire and the visible launch signature of the TOW missile increase the antiarmor squad's vulnerability, especially if an HMMWV-mounted TOW engages within an enemy's effective direct-fire range (no standoff). Antiarmor elements can reduce this vulnerability by displacing often and by integrating their fires with those of other weapon systems (M2 and MK19) within the antiarmor unit, with other antiarmor weapons within the battalion (Javelin and AT4), with obstacles, and with indirect fires. Integrated direct and indirect fires, with obstacles, complicate the enemy's target-acquisition process.

(4) Combat service support is limited for units conducting security missions. Additional support should be coordinated with a higher headquarters when an antiarmor unit participates in a security mission.

1-5. ENEMY ANTIARMOR COUNTERMEASURES

Two events have contributed significantly to the worldwide proliferation of antitank, guided missile-countermeasures (ATGM-CM): the end of the Cold War and the dramatic allied success in the Persian Gulf War. The success of ATGMs in the Persian Gulf War has resulted in the design and production of ATGM-CM devices. The ATGM-CM devices available include: use of antiarmor reaction drills, indirect fire, direct fire, reactive armor, camouflage, smoke and obscurants, active protection systems, sensors including laser warning receivers, infrared and laser jammers, and blinders. Although most of the ATGM-CM devices have yet to prove their combat effectiveness, TOW weapon system engagements may become more difficult in the future. Enemy countermeasures to the weapon system include--

- Enemy actions taken before the TOW gunner fires.
- Enemy actions taken while the TOW missile is in flight.
- Enemy actions taken to reduce the effectiveness of the TOW when it hits.

a. **Enemy Actions Taken before the TOW Gunner Fires.** Enemy commanders can counter the effectiveness of the TOW well before exposing their combat formations to its fires. Enemy commanders may conduct aggressive reconnaissance to locate TOW positions and then attempt to destroy them with indirect fires and attack helicopters. Enemy forces are likely to employ deception, camouflage, and heavy use of obscurants to degrade the target acquisition capabilities of the TOW.

(1) **Reconnaissance.** All armies reconnoiter continuously to locate and to target antiarmor systems. To protect friendly units from ground reconnaissance elements, US forces employ security operation forces, which must use all available concealment to augment information sharing (digital and nondigital). US forces also use dummy and hide positions to help give the enemy a false picture of the US defense.

(2) **Deception.** Deception is part of the doctrine of all modern armies. It includes using camouflage to disguise, conceal, or distort; using darkness, weather, and obscurants to mask operations; using decoy equipment; masking light and sound; conducting diversionary actions or demonstrations; and practicing communications security.

(a) **Camouflage.** Many armored vehicles are now equipped with various methods to reduce their signatures and conceal their presence, to include--

- Camouflage paint.
- Camouflage nets to provide concealment from both optics and radar.
- Low silhouette profiles.
- Less dependence on active infrared (IR) during limited visibility.

(b) **Smoke and Obscurants.** Enemy forces may employ obscurants to mask movement from identified or templated TOW positions. Natural dust and obscurants restrict the capability of thermal sights and TOW guidance mechanisms. Obscurant-filled projectiles are typically used to lay blinding smoke on TOW positions. Improved obscurants can degrade thermal sights. Dust kicked up by high explosive projectiles, mortar, artillery, rocket, and tracked vehicle movement is an effective screening agent that blocks out thermal, laser, and direct view optics.

(c) **Decoys.** Many countries have developed full-sized tank decoys that confuse TOW gunners. Heat sources can be used to defeat, degrade, or confuse TOW guidance systems.

(d) **Artillery and Mortars.** The enemy tries to suppress or destroy TOW weapon systems by either observed or unobserved fires on known or likely positions. Some armies have 122-mm and 152-mm howitzers to fire flechette rounds that are effective against unprotected soldiers and equipment. These rounds have a maximum range of 15,300 to 17,000 meters. Each round explodes above the ground and scatters about 8,500 small, finned flechettes over an area about 30 meters in diameter.

(e) **Attack Helicopters.** The enemy may follow the previously described preparatory fire with attack helicopters. Enemy attack helicopter pilots follow concealed routes that allow them to approach the flank or rear of each antiarmor unit undetected.

b. **Enemy Actions Taken While the TOW Missile is in Flight.** Enemy armor units are trained and equipped to counter TOW fires. This training includes terrain driving, suppressing or destroying TOWs with direct fire, use of on-board obscurants, and active protection systems.

(1) **Terrain Driving.** Enemy forces make use of contours in the terrain (dead space) to reduce their exposure to TOWs. Antiarmor units must account for dead space by emplacing obstacles, by observation, and by the employment of other weapon systems (MK19, M203, and mortar or artillery fires).

(2) **Suppressing or Destroying ATGMs with Direct Fire.** The TOW missile's launch signature gives away its position, and armored crews are trained to engage these systems upon detection. Many enemy vehicles are armed with weapons and munitions that can suppress or destroy TOW positions.

(a) *Tanks*. Several Russian-produced tanks (T-55 AM modernized, T-64B, T-80, T-80U, and T-90) and the Boyevaya Mashina Pekhoty (BMP-3, Russian combat vehicle, infantry) can fire ATGM (AT-8, AT-10, AT-11). These missile-firing tanks can be used to destroy our antiarmor systems. However, *all* tanks can fire high explosive fragmentation (HE-FRAG) rounds at ranges beyond 4,000 meters. The 125-mm time-and-percussion-fused HE-FRAG round can be programmed to explode over a defensive position out to 5,000 meters or can be contact-detonated out to 9,700 meters to suppress or destroy antitank weapons. The use of hide positions before the enemy comes within range of the TOW limits the effectiveness of long-range, HE-FRAG munitions.

(b) *Light Armored Vehicles*. Light armored vehicles include reconnaissance vehicles, infantry fighting vehicles, and armored personnel carriers. These vehicles usually are armed with an automatic cannon, gun and or machine guns, and sometimes an ATGM with a 4,000- to 5,500-meter range. Many foreign ATGMs have thermal capability and other improvements, including faster missiles and blast warheads, for use against defensive positions. The BMP-3 100-mm HE-FRAG round can destroy TOW positions from 4,000 meters away. The weapons systems on these vehicles present a threat to TOW launchers. Antiarmor units protect themselves from direct fire through effective camouflage, use of available concealment, and by fighting from prepared fighting positions when possible. Movement to alternate firing positions after initial engagement limits enemy target acquisition capabilities. Antiarmor units may also opt to engage light armored vehicles with M2 or MK19 and mortar and or artillery fires to preserve the TOW weapon system for employment against other enemy armored vehicles.

(3) *On-board Obscurants*. On-board obscurants that quickly screen the vehicle include the smoke grenade launcher and the vehicle exhaust smoke system.

(a) *Smoke Grenade Launchers*. To counter the TOW threat, many countries have equipped their combat vehicles with smoke grenade launchers. Smoke grenade launchers provide a rapid means of screening the vehicle. Obscurants launched from these grenade launchers can block the view of the target or interfere with the TOW's guidance system. Grenades available for some of these systems include smoke, antipersonnel, flare, tear gas, and IR decoy. Improved obscurants can degrade thermal sights and ATGM guidance systems. The grenade launchers are activated from inside the vehicle.

(b) *Vehicle Engine Exhaust Smoke System (VEESS)*. The VEESS, or similar system, sprays diesel fuel into the exhaust manifold. This system produces obscurants to protect the unit's movement. Obscurants from these systems interfere with direct view optics, image intensifier (I2 or starlight) sights, TOW guidance systems, and lasers. While thermal sights enable the gunner to see through some smoke, the gunner may not be able to maintain control of the missile through the smoke. The gunner may lose the missile unless he is using a TOW 2 family of missiles, a modified missile guidance system, and the thermal sight. In addition to using the TOW 2 capabilities, the dispersal of antiarmor squads around planned engagement areas limits the effectiveness of the enemy's on-board obscurants.

(4) *Active Protection Systems*. Active protection systems electronically sense incoming direct-fire ATGMs and high explosive, antitank (HEAT) munitions, and they defeat the incoming munitions before they impact the vehicle. Soft-kill active protection systems cause the munitions to miss. Hard-kill active protection measures fire munitions at the incoming round to destroy, neutralize, or detonate it.

(a) *Laser Warning Receivers.* Many armored vehicles are equipped with laser-warning receivers that alert the crew when their vehicle has been lased by a laser range finder. By using the laser-warning receiver, the crew identifies the type of laser range finder or designator and the direction of the laser. The crew then can take evasive action by either firing its weapons at the laser or by launching smoke. Some tanks have their laser warning receivers linked to the smoke grenade launchers, causing smoke to be employed automatically when lased. To counter this capability, the antiarmor squad limits the use of laser range finders. When laser range finders are used, they select an object at least three-vehicle lengths away from the target. Another potential action is to use the laser against suspected enemy positions to trigger their laser-warning receiver. This action causes the vehicle to launch smoke grenades, which confirms its presence.

(b) *ATGM Jammers.* The ATGM infrared jammers use an infrared signal to jam and then confuse ATGM guidance in flight with erroneous signals, causing the ATGM to miss the target. Counter-countermeasures include use of the TOW 2 family with modified missile guidance systems and thermal sight, or detecting the ATGM jammer with thermal or image intensifier (for example, PVS-7B) before launch and choosing a different attack method.

(c) *Hard-Kill Systems.* There are several hard-kill active protection systems such as the “Drozd” and the “Arena.” These systems have mounted counter munitions that are fired at incoming munitions when detected by the system’s radar. These systems do not protect the vehicle from all directions. The TOW gunners engage targets in vulnerable areas when possible. Use of mortars and artillery may destroy externally mounted sensors and countermeasure dispensers.

c. Enemy Actions Taken to Reduce the Effectiveness of the TOW When It Hits. The most effective enemy countermeasure in this category is the use of reactive armor. Reactive armor contains explosives sandwiched between metal plates. The explosive detonates and jettisons the outer metal upon contact with shaped-charge munitions. The rapid motion of the outer metal plate disrupts the shaped-charge, reducing penetration. Newer reactive armor can be developed to counter the ATGMs that were developed to defeat first-generation reactive armor with either tip charges (TOW 2A) or a top attack (TOW 2B).

CHAPTER 2

BATTLE COMMAND AND TROOP-LEADING PROCEDURES

Battle command is the exercise of command in operations against a hostile, thinking enemy. It uses the leadership element of combat power to assimilate thousands of bits of information to visualize the operation, describe it in terms of intent, and direct the military actions of subordinates to achieve victory. Thinking and acting are simultaneous activities for antiarmor leaders in battle. Battle command covers the knowledge, techniques, and procedures necessary to control operations and to motivate soldiers and their organizations into action to accomplish assigned missions. As part of battle command, commanders visualize the current state of the battlefield as well as future states at different points in the operation; they then formulate concepts of operations that allow their units to progress from one state to the other at the least cost. Other elements of battle command include assigning missions, prioritizing and allocating resources, selecting the critical times and places to act, and knowing how and when to make adjustments during the fight.

Section I. COMMAND AND CONTROL

Command and control is the exercise of authority and direction by a properly designated commander over assigned or attached forces in the accomplishment of the mission. The goal of command and control is mission accomplishment.

2-1. DEFINITION OF COMMAND AND CONTROL

Command and control are interrelated.

a. **Command.** Command is the art of assigning missions, prioritizing resources, guiding and directing subordinates, and focusing the unit's energy to accomplish clear objectives. The commander's will to win, morale, and physical presence must be felt by those whom he leads. Leading soldiers and units to successfully accomplish the mission remains a command imperative; safeguarding soldiers is an inherent responsibility of command.

b. **Control.** Control is the regulation of forces and other battlefield operating systems (BOS) to accomplish the mission in accordance with the commander's intent. It is the science of defining limits, computing requirements, allocating resources, monitoring performance, and directing subordinate actions to accomplish the commander's intent.

c. **The Command and Control System.** The command and control (C2) system within an antiarmor unit is the arrangement of personnel, information management, procedures, and equipment and facilities essential to plan, prepare for, execute, and assess operations. The C2 system must be reliable, responsive, and durable. It must withstand crises, even the loss of the leader, and still continue to function. Although it is the most complex system in the unit, C2 must result in clear, concise instructions that focus the entire unit toward the objective.

2-2. CONCEPT OF COMMAND AND CONTROL

Historically, military commanders have employed variations of the two basic command and control concepts: detailed command and mission command.

a. **Detailed Command.** Detailed command centralizes information and decision-making authority. Orders and plans are detailed and explicit, and successful execution depends on strict obedience by subordinates with minimal decision making or initiative on their part. Detailed command emphasizes vertical, linear information flow where information flows up the chain of command and orders flow down.

b. **Mission Command.** Mission command concentrates on the objective of an operation and not on how to achieve that objective. It is the conduct of military operations through decentralized execution based on mission orders for effective mission accomplishment. Successful mission command results from subordinate leaders at all echelons exercising disciplined initiative within the commander's intent to accomplish missions. It requires an environment of trust and mutual understanding. Today's operational environment emphasizes the need for rapid decision-making and execution to include rapid response to changing situations. It stresses trust and mutual understanding among superiors and subordinates. Mission command accepts the uncertainty of war by reducing the need for complete certainty in order to act. Because mission command decentralizes decision making authority and grants subordinates significant freedom of action, it demands a leader who is thoroughly versed in Army doctrine and who is disciplined, informed, innovative, dynamic, audacious, confident, and competent.

2-3. LEADERSHIP

Leadership is the critical element of both the C2 system (personnel) and combat power. Through leadership, the commander inspires and directs his unit to complete demanding tasks in difficult situations. In addition, the following factors are essential to the company commander's ability to lead his company on the battlefield.

a. **Will.** Often the victor in battle is the unit that refuses to lose. Competent leaders and tough, realistic training are the keys to developing this determination. The leader must develop a "will to win" in his soldiers and his unit.

b. **Trust.** The leader must earn the trust of his soldiers. They must have confidence in his abilities. The leader also must trust his soldiers and develop a climate that allows subordinates to make decisions.

c. **Delegation.** After ensuring his subordinates are well trained, the leader must delegate the proper authority and freedoms to his men. He focuses his time and energy on what he determines as critical, and delegates the remainder to his subordinates.

d. **Discipline.** The leader instills discipline in his soldiers. Discipline ensures that proper standards are maintained in the absence of leader supervision. The decentralized operations conducted by antiarmor companies and platoons require self-discipline of every soldier in the unit.

2-4. FUNDAMENTALS OF COMMAND AND CONTROL

The following fundamentals describe methods of directing military operations that encourage and expect subordinates to take action consistent with the intent and concept of higher headquarters.

a. **Expect Uncertainty.** The leader must understand the environment of combat; the battle will be dynamic and non-linear. Communications will be degraded, and the chaos of battle will often prevent the commander from knowing what is happening beyond his own senses. The situation that exists during planning will likely change before execution.

b. **Reduce Leader Intervention.** The leader plans and directs operations to require the absolute minimum leader intervention during execution. When soldiers expect the leader to make the decision or initiate the action, they are reluctant to take action. When precise control is required for synchronization, such as an on-order task, the leader should also provide the subordinate the criteria for making the decision. Leaders must realize that some loss of precision is better than inactivity.

c. **Increase Subordinate Planning Time.** The commander ensures the effective use of all available planning time. Although the majority of the planning takes place at the battalion and company level, the antiarmor platoons, sections, and squads require extra time to conduct their rehearsals and inspections. A unit standing operating procedure (SOP) is a key tool for managing time well.

d. **Give Subordinates Maximum Freedom of Action.** Given the expected operational environment, leaders at every level avoid placing unnecessary limits on their soldiers' freedom of action. The leader at the point of decision must have the knowledge, the training, and the freedom to make the correct decision that supports the commander's intent.

e. **Lead Well Forward.** The leader locates where he can best fight his unit. This is determined by a number of factors. His leadership is most effective face-to-face when he can see the situation and his soldiers can see him. Since he cannot be everywhere, he focuses on the decisive action that will accomplish his mission. He normally locates with his main effort (the subordinate unit assigned the decisive action) to provide his leadership and to be in a position to shift or re-task the main effort.

2-5. COMMAND AND CONTROL RESPONSIBILITIES

Antiarmor company commanders and platoon leaders train and maintain their units to conduct sustained operations. All leaders must ensure that their soldiers are tactically and technically proficient in the weapons systems found in the unit.

a. **Antiarmor Company Commander.** The commander employs command and control to ensure the antiarmor company accomplishes its missions. He is also responsible for the tactical employment, training, administration, personnel management, and sustainment of his company. He must know the capabilities of his men and weapons systems and how to tactically employ them. The antiarmor commander exercises command through his subordinate leaders. In an airborne and air assault battalion or an SBCT, he serves as an advisor to the higher commander concerning employment of all antiarmor assets.

b. **Antiarmor Company Executive Officer.** The executive officer (XO) is the second in command of the company. He assists the company commander control the fires and movement of the antiarmor platoons. The XO frees the company commander of all distractions to allow the company commander to control the company's most critical actions. (For example, the XO submits situation reports to the higher headquarters' main command post, relays information to the company commander such as enemy and friendly situational updates, and communicates with adjacent units.) During preparation

for combat operations, the XO serves as the company's primary CSS planner and makes the necessary coordination with the higher headquarters. He provides the company first sergeant with the CSS plan for execution.

c. **Antiarmor Company First Sergeant.** The first sergeant (1SG) is the senior noncommissioned officer (NCO) in the company and is normally the most experienced soldier in the company. He advises the company commander on tactical employment, and he is the expert on individual and NCO skills. He assists the company commander to plan, coordinate, and supervise all activities that support the mission. During execution, the 1SG is the primary CSS executor.

d. **Antiarmor Platoon Leader.** The antiarmor platoon leader (PL) is responsible for training, maintaining, and tactically employing the platoon. His responsibilities include planning, coordinating, and integrating the platoon's fires to fit the supported unit's tactical plan. He knows the abilities of his weapons systems and is skilled in their use. The platoon leader must also be proficient in calling for and adjusting indirect fires. He employs his platoon tactically based on orders from the commander (battalion, antiarmor company, or supported rifle company). In the light infantry battalion, he serves as an advisor to the battalion commander concerning employment of his platoon's weapons systems and all other antiarmor assets.

e. **Antiarmor Platoon Sergeant.** The antiarmor platoon sergeant (PSG) is normally the most experienced soldier in the platoon. He leads the elements of the platoon as directed by the platoon leader; he assumes responsibility of the platoon in the platoon leader's absence. The PSG is responsible for individual training, advising the platoon leader on tactical employment of the platoon's weapons systems, and helping to control the platoon during combat operations. He supervises equipment maintenance, supply, and casualty evacuation.

f. **Antiarmor Section Leader.** The section leader is responsible for the discipline and training of his two antiarmor squads and for the maintenance of his section's equipment. During operations, he selects the location of primary, alternate, and supplementary firing positions. He controls the section's fires and movement, and he ensures mutual support is achieved with other elements with which he is operating. He also serves as the squad leader for one of his squads.

g. **Antiarmor Squad Leader.** The squad leader is responsible for the discipline and training of his squad and the maintenance of his equipment. He is skilled in all aspects of his weapons systems. He employs his squad in accordance with orders from the section leader. He detects and identifies targets, issues fire commands, and controls the fires and movement of his squad.

2-6. COMBAT ORDERS

Combat orders focus on what tasks must be accomplished without dictating in detail how they will be done. Whenever possible, they are oral orders issued face-to-face on the ground where the fight will take place.

a. **Brevity and Clarity.** Combat orders require well-trained subordinates who understand their commanders' intent and concepts (two levels higher). Combat orders address only the required information. They avoid unnecessary detail and redundancy and do not restate doctrine or SOPs.

b. **Tailoring.** The leader determines exactly what he wants his unit to accomplish and clearly communicates these requirements to them. If one of his subordinates has not displayed the tactical competence to operate with a combat order, then the order must be tailored based on the training, experience, and capability of the subordinate leader receiving the order.

(1) This tailoring may include nothing more than providing additional instructions, establishing more restrictive control measures, or directing a specific use for one of his organic assets.

(2) A commander may detail exactly how the platoon leader will employ his entire platoon, clearly state the limits for using his initiative, and collocate himself or the company XO with this platoon. This should be only a short-term solution; leaders must be trained to meet their responsibilities.

Section II. TROOP-LEADING PROCEDURES

Troop-leading procedures (TLP) are a sequence of actions that enable the company commander (or platoon leader) to use available time effectively and efficiently in the planning, preparing, executing, and assessing of combat missions. Collectively, the TLP are a tool to assist leaders in making, issuing, and supervising operation orders. The TLP are integrally coupled with the military decision-making process (MDMP). The company commander and platoon leader must be knowledgeable of their information-gathering resources and must plan operations to maximize the communications that make access to this information possible. Beyond the communications, the need to apply both known and templated enemies in planning processes is paramount.

2-7. APPLICATION OF TROOP-LEADING PROCEDURES

The following discussion of troop-leading procedures (Figure 2-1) assumes that the company commander (or platoon leader) will plan in a time-constrained environment. As such, the suggested techniques are oriented to help him quickly develop and issue a combat order.

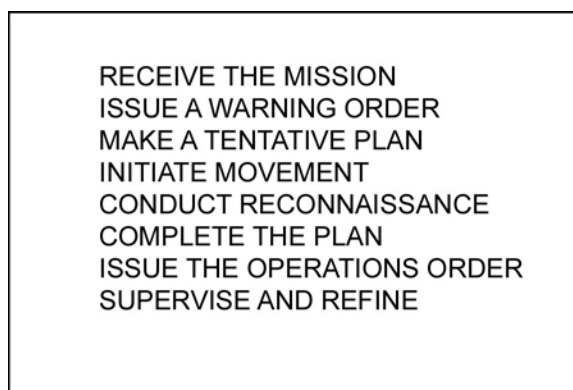

Figure 2-1. Troop-leading procedures.

a. Troop-leading procedures are consistent with the MDMP described in FM 5-0 (FM 101-5). The two are not identical, however, because specific steps of the MDMP are designed and intended to help coordinate staff and commander responsibilities of units with staffs. While the antiarmor company commander and platoon leader have

subordinate leaders who assist them with aspects of planning operations, these leaders are not a staff. This fact places the burden of planning on the shoulders of the company commander (or platoon leader). The TLP reflect this reality while incorporating the spirit, language, and general process of the MDMP to assist in the preparation of an operations order (OPORD).

b. The TLP are not a hard and fast set of rules. Rather, they provide a guide that the company commander (or platoon leader) applies in ways that are consistent with the situation, his experience, and the experience of his subordinate leaders. The tasks involved in some steps (such as issue the warning order, initiate movement, and conduct reconnaissance) may recur several times. The last step, the activities of supervising and refining the plan, occur throughout the troop-leading procedures. The following outline of the TLP assumes that the company commander (or platoon leader) will plan in a time-constrained environment. The suggested techniques can help him quickly develop and issue a combat order. The higher headquarters may issue two warning orders before the company commander (or platoon leader) begins his TLP.

(1) In accordance with FM 5-0, the warning order will address the following elements at a minimum: type of operation, general location of operation, any reconnaissance to initiate, any movement to initiate, and an initial timeline. The higher headquarters may issue additional information in the first warning order (for example, products from current staff or commander estimates). The leader will conduct his initial planning-time analysis, which allows him to determine the total amount of time to plan and prepare. This initial planning-time analysis is the basis for the detailed time analysis that will be conducted as planning continues. He analyzes the time his unit has available and prepares an initial time line. He should plan to use no more than one-third of the available planning time, thus leaving his subordinates with two-thirds of the available time. An effective technique to manage the available time is for the leader to issue his operations order in approximately one-fifth of the available planning time. This provides additional time for rehearsals without cutting into subordinate planning time. He should take into account ambient light effects for his timeline.

(2) The anitarmor company commander (or platoon leader) may issue a warning order immediately following the higher headquarters' initial warning order. He addresses the same elements of the higher headquarters' initial warning order in his initial warning order. The most important element of this warning order is his initial planning timeline. He may also pass on any other instructions or information that he thinks will assist his subordinates in preparing for the upcoming mission. If practical, he assembles his subordinate leaders to receive the warning order face-to-face from the actual terrain. If not practical, he may use a terrain model, sketch, or map. He may also use a digital information system (INFOSYS) such as Force XXI Battle Command Brigade and Below (FBCB2), if equipped. By quickly issuing his warning order the leader enables his subordinates to begin their own preparations while he develops the remaining warning orders and the OPORD. Warning orders, though not as detailed as an operations order, should follow the same five-paragraph format, providing as much information as possible with an initial timeline.

(3) The second warning order from the higher headquarters consists of the essential information derived from their mission analysis and the higher commander's guidance. It includes mission analysis results:

- Analysis of terrain.
- Enemy forces (paragraph 1a of the higher headquarters' OPORD to include the enemy situational template [SITEMP]).
- Higher headquarters' restated mission statement.
- Higher commander's intent.
- Area of operations (AO), area of influence, and area of interest.
- Commander's critical information requirements (CCIR).
- Risk guidance.
- Reconnaissance to initiate.
- Security measures.
- Deception guidance.
- Mobility/counter-mobility guidance.
- Specific priorities.
- Timeline.
- Guidance on rehearsals.

The higher headquarters may issue additional information in the second warning order (for example, friendly forces, paragraph 1b of the OPORD). The leader must understand the information given in higher headquarters' second warning order. He can conduct an assessment but will not complete a detailed analysis until he receives the mission. Depending on the situation, he may choose to issue an initial warning order to his subordinates following receipt of the higher headquarters' second warning order.

(4) The company commander (or platoon leader) may determine that he needs to issue a second warning order after receiving the higher headquarters' second warning order or after receiving other pertinent information. Since he does very little analysis with information received in the higher headquarters' second warning order, and depending on his situation, he may not issue the second company and or platoon warning order. He may choose instead to issue this information after receiving the higher headquarters' third warning order.

2-8. RECEIVE THE MISSION

As the title indicates, this step addresses the actions a company commander (or platoon leader) takes as he receives his mission. "Receiving" the mission may occur in one of several ways. It may begin with the receipt of a warning order from the higher headquarters, or it may not begin until he actually receives the higher headquarters' OPORD (which would be the case if the higher headquarters did not use warning orders prior to issuing the OPORD). In the most challenging situation, it may come about as a result of a change in the overall situation during execution. Besides receiving (or deducing) his mission during the first step of the TLP, the company commander (or platoon leader) must also assess the time he has available to prepare for and execute the mission. As a result of his time assessment, he prepares an initial timeline for planning and execution.

a. **Mission Analysis.** Although the focus of the first step of the TLP is on determining the unit mission and assessing the time available to accomplish the mission, this step also begins an activity called *mission analysis*. The company commander (or platoon leader) will not receive his mission until the higher headquarters produces its third warning order or the OPORD. For him, mission analysis is not as detailed as it is in

the higher headquarters' MDMP. His mission analysis is essentially an analysis of METT-TC considerations. He does this in as much depth as time and quality of information allows. Analyzing the factors of METT-TC is a continuous process. He constantly receives information from the time that he begins planning through execution. During execution, his continuous analysis enables him to issue well-developed fragmentary orders. He must assess if the new information affects his mission and his plan. If it does, he then must decide how to adjust his plan to meet this new situation. He does not need to analyze the factors of METT-TC in any set order or sequence. How and when he analyzes each factor depends on when information is made available to him, his own experience, and preference. One technique is to parallel the TLP based on the products received from the higher headquarters' MDMP. Using this technique, he analyzes *Mission* first, *Terrain & Weather, Enemy, Troops & Support, Time*, and finally *Civil Considerations*. This is not a hard and fast set of rules. Different elements of information that come into the unit must be analyzed and assessed.

(1) ***Analysis of Mission.*** Leaders at every echelon must have a clear understanding of the mission, intent, and concept of the operation of the commanders one and two levels higher. This understanding makes it possible to exercise disciplined initiative. The company commander (or platoon leader) captures his understanding of what his unit is to accomplish in his restated mission statement. He takes six steps to write his restated unit mission statement. These steps include analyzing the higher headquarters' (*two levels up*) mission, intent and concept; the immediate higher headquarters' (*one level up*) mission, intent, and concept; and identifying specified, implied, and essential tasks and any constraints.

(a) ***Higher Headquarters (Two Levels Up) Mission, Intent, and Concept.*** The antiarmor company commander (or platoon leader) understands this higher headquarters' concept of the operation. He identifies this headquarters' task and purpose and how his immediate higher headquarters is contributing to the fight. He also must understand the commander's intent (*two levels up*).

(b) ***Immediate Higher Headquarters (One Level Up) Mission, Intent, and Concept.*** The antiarmor company commander (or platoon leader) understands the immediate headquarters' concept of the operation. He identifies this headquarters' task and purpose as well as his contribution to this fight. The company commander must clearly understand the commander's intent from the OPORD (*one level up*). Additionally, he identifies the task, purpose, and disposition for all adjacent maneuver elements under this headquarters' control.

(c) ***Unit Mission.*** The antiarmor company commander (or platoon leader) finds his unit's mission in the concept of the operation paragraph in the immediate higher headquarters' OPORD. The purpose of the main effort unit usually matches the purpose of the immediate higher headquarters. Similarly, supporting effort unit's purposes must relate directly to the main effort unit accomplishing its purpose. The company commander (or platoon leader) must understand how his antiarmor unit relates to the purposes of the other units. Finally, he determines his unit's mission essential tactical task. The unit must accomplish this task in order to accomplish the assigned purpose. He must understand why the commander (*one level up*) assigned his unit the particular tactical task and determine how it fits into the immediate higher headquarters' concept of the operation.

(d) *Constraints*. Constraints placed on the leader by a higher command to dictate an action or inaction restricts the freedom of action the subordinate leader has for planning by stating the things that he must or must not do. The company commander (or platoon leader) identifies all constraints the OPORD places on the unit's ability to execute its mission. There are two types of constraints: proscriptive (requirements for action) and prohibitive (requirements for inaction).

(e) *Identify Tasks*. The company commander (or platoon leader) must identify and understand the tasks required to accomplish a given mission. There are three different types of tasks: specified, implied, and essential.

- **Specified Tasks**. These are tasks specifically assigned to a unit by a higher headquarters. Paragraphs 2 and 3 of a higher headquarters' order or plan state specified tasks. Specified tasks may also be found in annexes and digital overlays (for example, "suppress enemy on OBJ FOX," "reconnoiter Route BLUE," "assist the forward passage of B Company," "send two soldiers to assist in the loading of ammunition").
- **Implied Tasks**. These are tasks that must be performed to accomplish a specified task but are not stated in a higher headquarters' order. Implied tasks are derived from a detailed analysis of the higher headquarters' order, the enemy situation and courses of action, and the terrain. Analysis of the unit's current location in relation to future areas of operation as well as the doctrinal requirements for each specified task might provide implied tasks. Only those tasks that require allocation of resources should be retained.
- **Essential Tasks**. These tasks are important for the success of the unit. They are derived from a review of the specified and implied tasks. An essential task that must be executed to accomplish the assigned purpose is the mission essential task.

(f) *Restated Mission Statement*. The leader prepares his restated mission statement expressed around the five W's: *who*, *what*, *when*, *where*, and *why*. The "*who*" is the company and or platoon; the "*what*" is the unit's mission essential task. The "*when*" is given in the higher headquarters' OPORD; the "*where*" is the objective or location taken from the higher headquarters' OPORD; and the "*why*" is the company and or platoon purpose taken from the higher headquarters' concept of the operation. An example of an antiarmor company restated mission statement follows:

EXAMPLE: D/1-52 IN defends from BP D-1 NLT 012000 October__ to destroy enemy MRB in EA FOX to prevent enemy forces from bypassing 2-52 IN, the brigade main effort.

(2) *Analysis of Terrain and Weather*. If the higher headquarters has developed a modified combined obstacle overlay (MCOO), the company commander (or platoon leader) can quickly accomplish his analysis of the terrain. From the MCOO he will already have an appreciation for the general nature of the ground and the effects of weather. However, he must conduct his own detailed analysis to determine how terrain and weather will uniquely affect the antiarmor unit's mission and the enemy. He must go beyond merely passing along the MCOO to his subordinate leaders and making a general observation of the terrain (for example, this is high ground). He must arrive at significant

conclusions about how the terrain and weather will affect the enemy and the unit. Most importantly, the company commander (or platoon leader) will apply these conclusions when he develops courses of action for both enemy forces and his unit.

(a) *Classifying Terrain Mobility*. Terrain mobility is classified in one of four categories: unrestricted, restricted, severely restricted, and complex.

- Unrestricted. This terrain is free of any restrictions to movement; no actions are required to enhance mobility. This type of terrain generally allows wide maneuver and offers unlimited travel over well-developed road networks.
- Restricted. This terrain hinders movement to some degree. Little effort is needed to enhance mobility, but units may need to detour frequently. They may have difficulty maintaining optimum speed, moving in some types of combat formations, or transitioning from one formation to another.
- Severely restricted. This terrain severely hinders or slows movement in combat formations unless some effort is made to enhance mobility. It may require commitment of engineer forces to improve mobility, or it may require deviation from doctrinal formations and or deviation from doctrinal rates of march.
- Complex. Complex terrain includes two or more of the traditional classifications of terrain. For example, complex terrain may have an area of forest that is restricted along with an urban area that is severely restricted.

(b) *Prioritizing Terrain Analysis*. Limited available planning time may force the company commander (or platoon leader) to prioritize his terrain analysis. For example, in the conduct of an attack, an antiarmor company commander may prioritize the area immediately around the objective for analysis, followed by the company's specific axis leading to the objective. Given more time, he may then analyze the remainder of his company's area of operation and area of interest.

(c) *Using Visual Aids*. The company commander (or platoon leader) prepares some sort of visual aid to depict and explain the results of his analysis for his subordinates so they can understand his conclusions about the effects that the terrain and weather will have on the mission. This visual aid could be a hand drawn overlay for a map sheet, or it may be a terrain model. The visual aid may also be FBCB2, if available. Whatever the chosen method, he must include graphical depictions of terrain mobility classification, key terrain, inter-visibility (IV) lines, known obstacles, and avenues of approach and mobility corridors.

(d) *Using OAKOC*. The military aspects of terrain (OAKOC), Figure 2-2, are used to analyze the ground. The sequence used to analyze the military aspects of terrain can vary. The leader may prefer to determine *Obstacles* first, *Avenues of Approach* second, *Key Terrain* third, *Observation and Fields of Fire* fourth, and *Cover and Concealment* last. For each aspect of terrain, the company commander (or platoon leader) determines its effect on both friendly and enemy forces. These effects translate directly into conclusions that can be applied to either friendly or enemy courses of action. One technique to analyze terrain is to use a matrix. See Figure 2-3 (Analysis of Terrain Matrix).

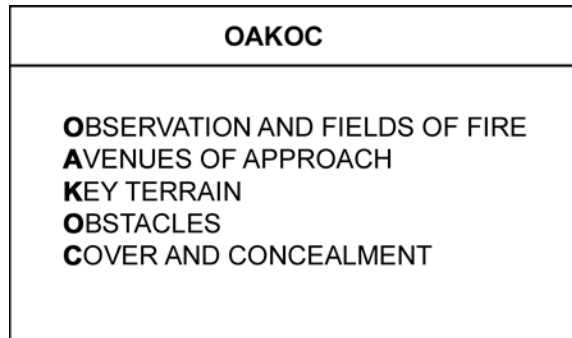

Figure 2-2. Military aspects of terrain.

		Effects	Conclusions
Obstacles		Friendly	
		Enemy	
Avenues of Approach		Friendly	
		Enemy	
Key Terrain #1	Observation	Friendly	
		Enemy	
	Fields of Fire	Friendly	
		Enemy	
	Cover	Friendly	
		Enemy	
	Concealment	Friendly	
		Enemy	

Figure 2-3. Analysis of terrain matrix.

(e) *Obstacles.* The leader first identifies existing and reinforcing obstacles in his area of operation that limit mobility with regards to the mission. Existing obstacles include, but are not limited to, the following:

- Ravines.
- Gaps and ditches over 3 meters wide.
- Tree stumps and large rocks over 18 inches high.
- Forests with trees 8 inches or more in diameter with less than 4 meters between trees.
- Man-made existing obstacles (ie. buildings or power and telephone lines).

Reinforcing obstacles include, but are not limited to, the following:

- Minefields (conventional and situational).
- Antitank ditches.
- Wire obstacles.

Figure 2-4, page 2-12, lists several offensive and defensive considerations the antiarmor company commander or platoon leader can include in his analysis of obstacles and restricted terrain.

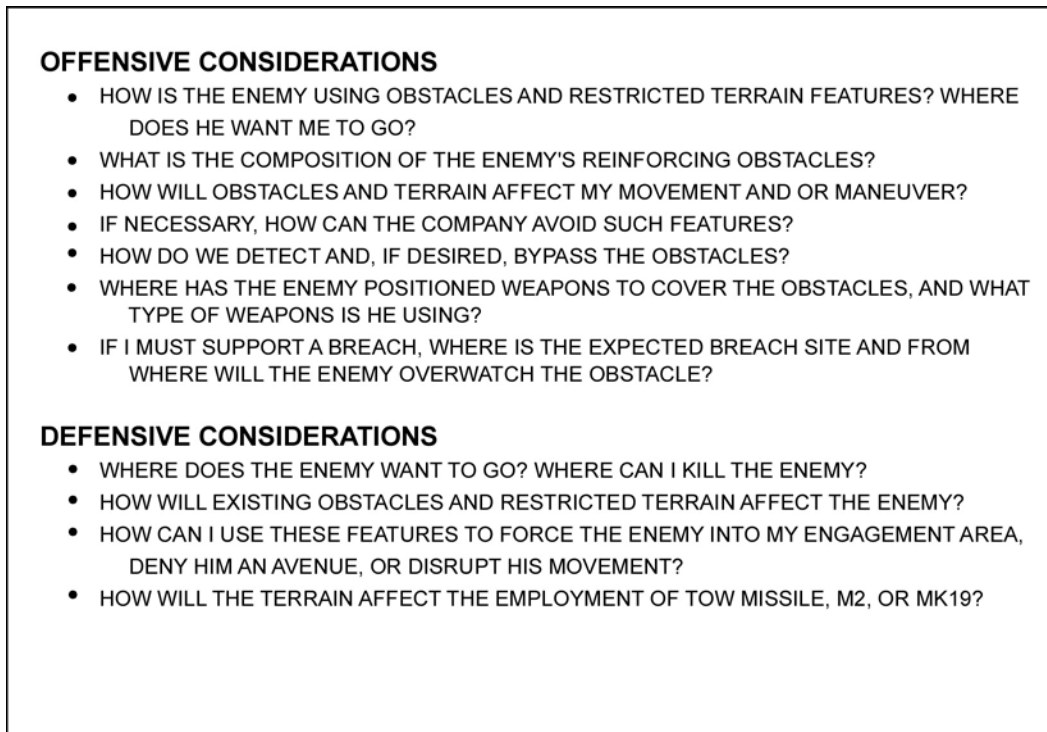

Figure 2-4. Considerations in analysis of obstacles and restricted terrain.

(f) *Avenues of Approach.* An avenue of approach is an air or ground route of an attacking force leading to an objective or key terrain. Avenues of approach are classified by type (mounted, dismounted, air, or subterranean), formation, and speed of the largest unit that can travel along it. First, the company commander (or platoon leader) must identify mobility corridors, if not provided by the higher headquarters. Mobility corridors are areas where a force can move in a doctrinal formation at a doctrinal rate of march; they are classified by type and size of force and formation employed.

Example 1: A motorized rifle platoon (MRP) moving in column (MRP-Column).

Example 2: An enemy squad moving in a wedge (dismounted SQD-Wedge)

The company commander groups mutually supporting mobility corridors to form an avenue of approach. If mutually supporting mobility corridors do not exist, then a single mobility corridor may become an avenue of approach. Avenues of approach are classified in the same manner as a mobility corridor. After identifying these avenues of approach, he must evaluate each one and reach a conclusion as to its importance to the situation. Figure 2-5 lists several offensive and defensive considerations that an antiarmor company commander (or platoon leader) can include in his evaluation of avenues of approach.

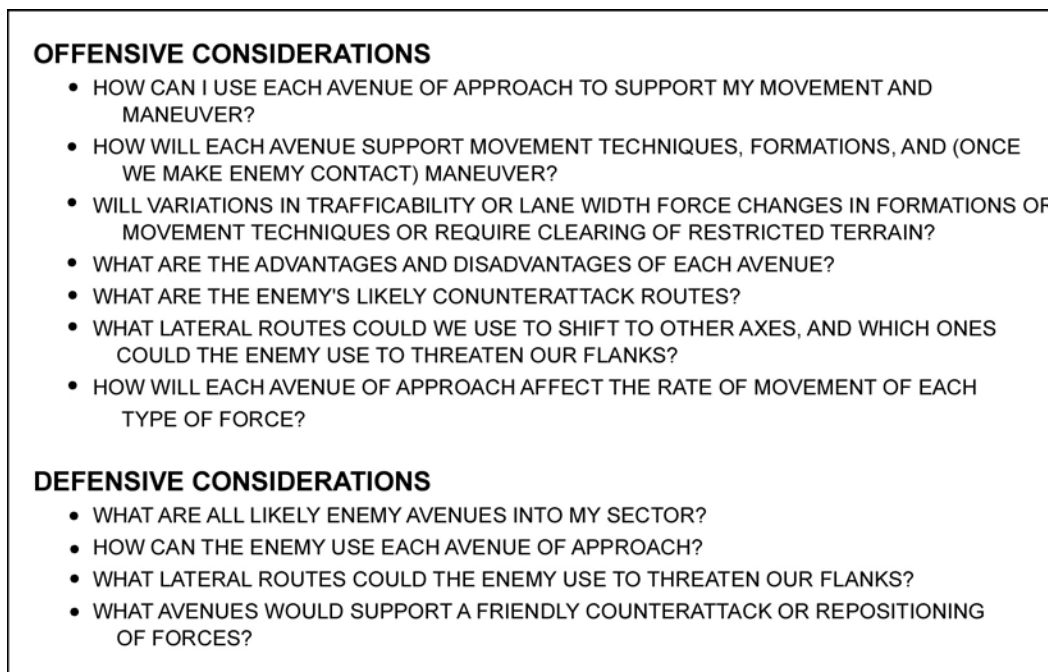

Figure 2-5. Considerations in avenue of approach analysis.

(g) *Key Terrain*. The company commander (or platoon leader) must identify key terrain. Key terrain is any location or area of which the seizure, retention, or control affords a marked advantage to either combatant. It is a conclusion rather than an observation; a prominent hilltop overlooking an avenue of approach, for example, may or may not be key terrain. Even if the hill offers clear observation and fields of fire, it is of no marked advantage to the unit that controls it if the opposition can easily bypass it on another avenue of approach. On the other hand, if the hilltop affords cover and concealment, observation, and good fields of fire on multiple avenues of approach or is the only avenue of approach in the area, the terrain offers a definite advantage to whoever controls it. Furthermore, an area where several trails converge may be key terrain for an antiarmor platoon, whereas an area in which several battalion-size avenues of approach join may prove key for an antiarmor company. Figure 2-6, page 2-14, lists several considerations that can be included in his analysis of key terrain.

- He must assess what terrain is key to his mission accomplishment. An example of key terrain for an antiarmor company in the attack could be a small hill or tree line that overlooks the enemy's reverse slope defense. Controlling this area may be critical in establishing a support-by-fire position to protect the breach force.
- He also must determine if any ground is *decisive terrain*. This is key terrain for which the seizure, retention, or control is necessary for mission accomplishment. Decisive terrain is not present in every situation. By determining that terrain is decisive, he recognizes that seizing or retaining it is an absolute requirement for successful accomplishment of the mission.

NOTE: An SBCT antiarmor company must address communications coverage. The ability to develop and share a plan using the available digital INFOSYS

(FBCB2) requires the antiarmor company commander to operate within the ability of that communications system. The decision to operate outside of communications coverage must be a deliberate decision and not random chance.

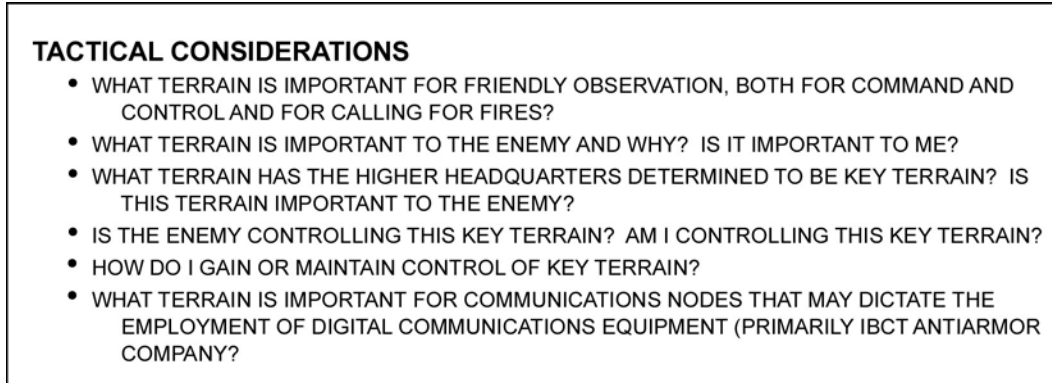

Figure 2-6. Considerations in key terrain analysis.

(h) *Observation and Fields of Fire.* The company commander (or platoon leader) must identify locations along each avenue of approach that provide clear observation and fields of fire for both the attacker and the defender. He analyzes the area surrounding key terrain, objectives, engagement areas, and obstacles. He locates IV lines (terrain that inhibits observation from one point to another) and assesses the ability of the attacking force to overwatch or support movement (with direct fire). In analyzing fields of fire, he focuses on both the friendly and enemy potential to cover terrain (especially avenues of approach and key terrain) with direct fires. Additionally, he must identify positions that enable artillery observers to call indirect fire. Whenever possible, he conducts a reconnaissance of the ground from both enemy and friendly perspectives. He might conduct this reconnaissance personally, by map, or with his subordinate units. This reconnaissance helps him to see the ground in a more objective manner and to see how the ground affects both enemy and friendly forces (Figure 2-7).

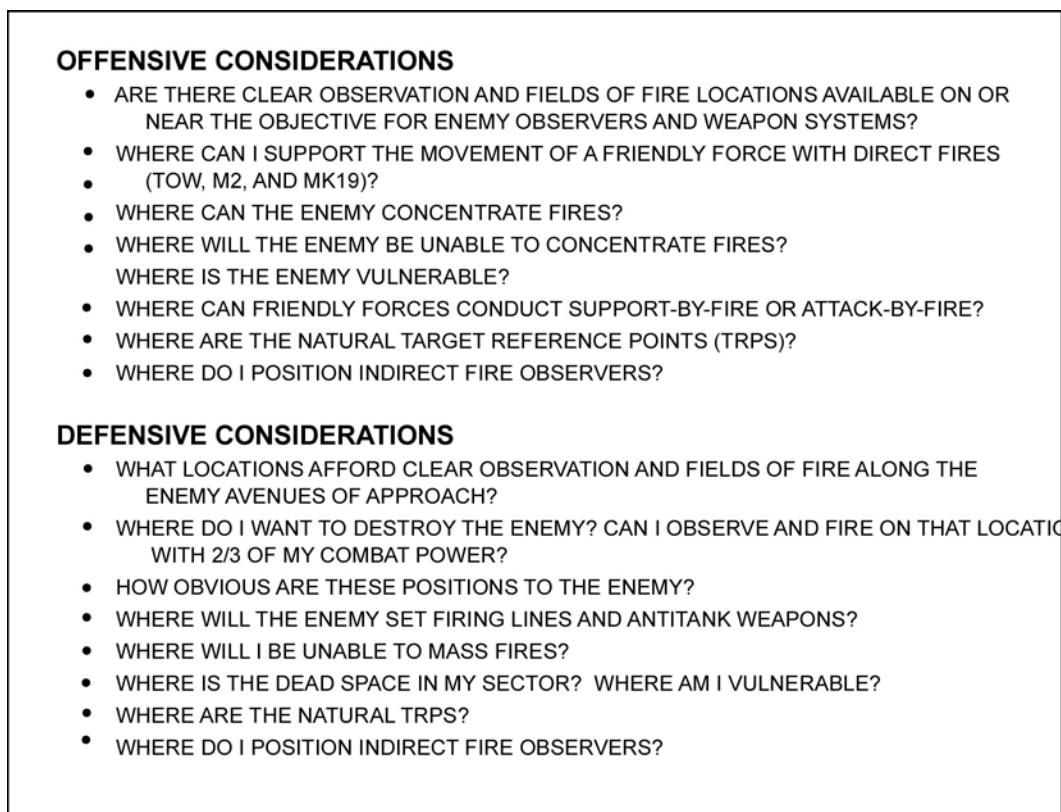

Figure 2-7. Considerations in analysis of observation and fields of fire.

(i) *Cover and Concealment.* The company commander (or platoon leader) looks at the terrain, foliage, structures, and other features along avenues of approach and on objectives or key terrain to identify sites that offer cover (protection from the effects of direct and indirect fire) and concealment (protection from observation). In the defense, weapon positions must be both lethal and survivable, and effective cover and concealment is just as vital as clear fields of fire (Figure 2-8).

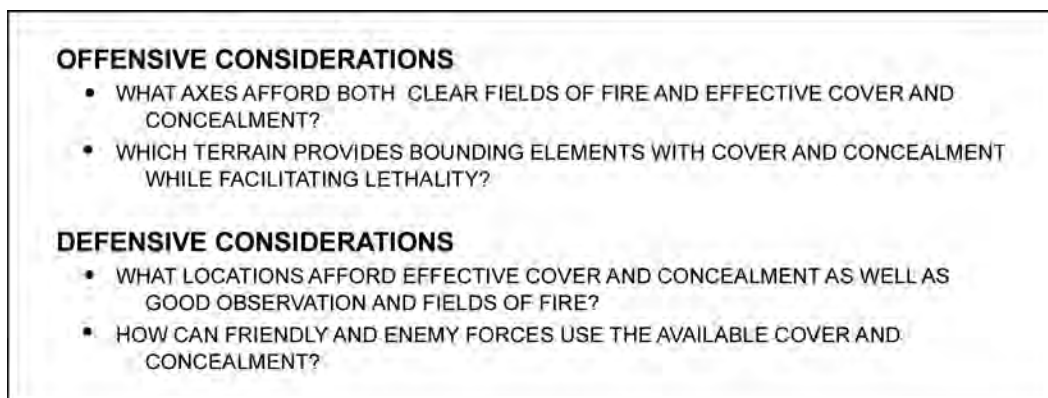

Figure 2-8. Considerations in analysis of cover and concealment.

(j) *Weather Analysis.* There are five military aspects of weather: visibility, winds, precipitation, cloud cover, and temperature and humidity. Consideration of the effects of

weather is an essential part of the company commander's mission analysis. The commander must go beyond merely making observations; he must arrive at significant conclusions about how the weather will affect the visibility, mobility, and survivability of his company and the enemy. The company commander (or platoon leader) reviews the conclusions from his higher commander and identifies his own critical conclusions about the five military aspects of weather. He must apply the results of his analysis when he develops friendly and enemy courses of action.

(k) *Visibility*. The company commander (or platoon leader) identifies critical conclusions about visibility factors (such as light data, fog, and smog) and battlefield obscurants (such as smoke and dust). He considers light data and identifies critical conclusions about beginning morning nautical twilight (BMNT), sunrise (SR), sunset (SS), end of evening nautical twilight (EENT), moonrise (MR), moonset (MS), and percentage of illumination. Some additional visibility considerations include--

- Will the sun rise behind my attack? Will I attack toward the sunrise?
- How can I take advantage of the limited illumination?
- How will this affect friendly and enemy target acquisition?
- Will the current weather favor the use of smoke to obscure during breaching?
- Will fog affect friendly and enemy target acquisition?

(l) *Winds*. The company commander (or platoon leader) identifies critical conclusions about wind factors (such as direction and speed) Some wind considerations include--

- Will wind speed cause smoke to dissipate quickly?
- Will wind speed and direction favor enemy use of smoke?
- Will wind speed and direction affect the employment of TOW missiles?

(m) *Precipitation*. The company commander (or platoon leader) identifies critical conclusions about precipitation factors (such as type, amount, and duration). Some precipitation considerations include--

- How will precipitation affect the mobility of the unit?
- How can precipitation add to the unit's ability to achieve surprise?

(n) *Cloud Cover*. The company commander (or platoon leader) identifies critical conclusions about cloud cover (such as limits on illumination and solar heating of targets). Some cloud cover considerations include--

- How will cloud cover affect unit operations at night? How will it affect the enemy?
- How will cloud cover affect the target acquisition?

(o) *Temperature and Humidity*. The company commander (or platoon leader) identifies critical conclusions about temperature factors (such as high and low temperatures and infrared crossover times) and battlefield factors (such as use of smoke or chemicals). Some temperature considerations --

- How will temperature (hot or cold) and humidity affect the rate of march for the unit?
- How will temperature (hot or cold) and humidity affect the soldiers and equipment?
- Will temperatures and humidity favor the use of non-persistent chemicals?

(3) *Enemy Analysis*. Analyzing the enemy consists of seven steps: doctrinal analysis, composition, disposition, strength, capabilities, company-level enemy SITEMP, and

initial priority intelligence requirements (PIR). The critical outcome of analyzing the enemy is for the company commander (or platoon leader) to identify the enemy's weaknesses so that he might exploit them by applying overwhelming combat power to achieve his purpose. He must know how the enemy will fight and the ground where the fight will occur. He must understand what is actually known of the enemy and what is merely templated. Without this appreciation, it is possible to develop an erroneous plan that is based solely on assumptions and therefore not a reliable prediction of what will occur. The company commander must understand the assumptions the battalion (or SBCT) S2 used to portray the enemy's courses of action. Furthermore, his own assumptions about the enemy must be consistent with those of his higher commander.

NOTE: In analyzing the enemy, the company commander (or platoon leader) must understand the intelligence preparation of the battlefield (IPB). Although he does not prepare IPB products for his subordinates, he must be able to use the products of the higher headquarters' IPB effectively

(a) *Doctrinal Analysis (How the Enemy Will Fight)*. It is not enough simply to know the number and types of vehicles, soldiers, and weapons the enemy has. The company commander (or platoon leader) must thoroughly understand when, where, and how the enemy prefers or tends to use the assets he possesses. A doctrinal template is a visual illustration of how the enemy force might look and act without the effects of weather and terrain. He looks at specific enemy actions during a given operation (such as defense out of contact, security zone defense, movement to contact, or asymmetric operations) and uses the appropriate doctrinal template to gain insights into how the enemy may fight. Likewise, he must understand enemy doctrinal objectives. In doctrinal terms, he asks: Is the enemy oriented on the terrain (for example, a forward detachment), on his own force (such as an advance guard), or on friendly forces (as in a security zone)? What effect will this have on the way the enemy fights? As the global situation changes, however, the possibility increases of fighting adversaries with no structured doctrine. Therefore, the process of templating the enemy would be somewhat limited. In such a situation, an antiarmor company commander (or platoon leader) must rely solely on information provided by the battalion or brigade reconnaissance assets. He also may make sound assumptions about the enemy, human nature, and local culture.

(b) *Composition*. His analysis must determine the types of vehicles, soldiers, and equipment the enemy could use against his unit. From the enemy forces paragraph (1a) or the intelligence annex of the higher headquarters' OPORD, he identifies the task and purpose of the enemy elements.

(c) *Disposition*. From higher headquarters' information, he determines how the enemy is (or might be) arrayed. Next, he determines the enemy's form of maneuver or defensive technique. If available, he determines from what echelon force the enemy comes. He determines the disposition for the next two higher enemy elements.

(d) *Strength*. He identifies the enemy's strength by unit. He can obtain this information by translating percentages given from higher headquarters to the actual numbers in each enemy element.

(e) *Capabilities*. Based on the S2's assessment and the enemy's doctrine and current location, the antiarmor company commander (or platoon leader) must determine the

enemy's capabilities. This also includes studying the maximum effective range for each weapon system, doctrinal rates of march, and associated timelines to perform certain tasks. One technique is to use the BOS as a checklist to address every significant element the enemy brings to the fight. The antiarmor company commander (or platoon leader) determines the capabilities of the next higher enemy element. These capabilities should include reasonable assets the next higher element, or other higher enemy headquarters, may provide. This should include, but is not limited to, employment of reserves, use of chemical weapons, artillery and or mortar locations and ranges, and employment of reconnaissance assets.

(f) *Enemy Situation Template (SITEMP)*. To identify how the enemy will potentially fight, the company commander (or platoon leader) weighs the result of his analysis of terrain and weather against the higher headquarters' SITEMP. The refined product is a company/platoon SITEMP--a visual/graphic depiction of how the company commander (or platoon leader) believes the enemy will fight under specific battlefield conditions. This SITEMP is portrayed one echelon lower than that developed by the higher headquarters' S2. For example, if a battalion SITEMP identifies a motorized rifle platoon on the company's objective, the company commander, using his knowledge of both the enemy's doctrine and the terrain, develops a SITEMP that positions individual vehicles from the MRP and possibly individual fighting positions or trenches in the platoon's defense. This SITEMP includes the likely range fan of the enemy's weapons and any tactical and protective obstacles, either identified or merely templated, which support the defense. Figure 2-9 depicts recommended SITEMP items. It is important to remember that the antiarmor company commander (or platoon leader) must not develop his SITEMP independently of the S2's product. The product must reflect the results of reconnaissance and shared information. Differences between the SITEMPs must be resolved before the antiarmor company commander (or platoon leader) may continue with his analysis of the enemy. Finally, given the scale with which the antiarmor company commander (or platoon leader) often develops his SITEMP, a 1:50,000 scaled map, it is advisable to transfer the SITEMP to a large-scale sketch for briefing purposes when the situation allows. This is not for analysis, but to enable subordinates to see the details of the anticipated enemy course of action (COA). Once he briefs the enemy analysis to his subordinates, the company commander (or platoon leader) must ensure they understand what is known, what is suspected, and what is merely templated (estimated). Unless given the benefit of reconnaissance or other intelligence (or digital enablers), his SITEMP is only an "estimate" of how the enemy may dispose himself. He must not take these as facts. Reconnaissance is critical in developing the best possible enemy scenario.

DEFENSE	OFFENSE
PRIMARY/ALTERNATE/SUBSEQUENT POSITIONS	ATTACK FORMATIONS
ENGAGEMENT AREAS	AXES OF ADVANCE
INDIVIDUAL VEHICLES	FIRING LINES
CREW-SERVED WEAPONS	OBJECTIVES
TACTICAL AND PROTECTIVE OBSTACLES	RESERVE FORCE COMMITMENT
TRENCHES	PLANNED INDIRECT FIRE TARGETS
PLANNED INDIRECT FIRE TARGETS	SITUATIONAL OBSTACLES
OBSERVATION POSTS	RECONNAISSANCE OBJECTIVES
COMMAND AND CONTROL POSITIONS	RECONNAISSANCE FORCE ROUTES
FPF AN FPL	PHASE LINES
LOCATION OF RESERVES	PLANNED POINT OF PENETRATION
ROUTES FOR RESERVE COMMITMENT	
TRAVEL TIME FOR RESERVE COMMITMENT	
BATTLE POSITIONS/STRONGPOINTS/SECTORS	
SECTORS OF FIRE	

Figure 2-9. Recommended SITEMP items.

(g) *Initial Priority Intelligence Requirements.* The company commander will develop his initial PIR. PIR are defined as information about the enemy that lead to a critical decision by a commander. Answering the PIR will allow the commander to clarify the enemy situation. Although the company commander's PIR will help clarify the enemy situation for him, they usually lead to answering the battalion commander's PIR. The antiarmor platoon leader in a light infantry battalion will typically use the battalion commander's PIR rather than developing his own.

(4) *Troop Analysis.* Perhaps the most critical aspect of mission analysis is determining the combat potential of one's own force. The company commander (or platoon leader) must realistically and unemotionally determine all available resources and any new limitations based on level of training or recent fighting. This includes troops who are either attached to or in direct support of his unit. He must know the status of his soldiers' morale, their experience and training, and the strengths and weaknesses of subordinate leaders. The assessment includes knowing the strength and status of his soldiers and their equipment as well as understanding the full array of assets that are in support of the unit. He must know, for example, how much indirect fire, by type, is available and when it will become available.

(5) *Time Analysis.* As addressed in the first step of the TLP, time analysis is a critical aspect to planning, preparation, and execution. The company commander (or platoon leader) must not only appreciate how much time is available. He must also be able to appreciate the time-space aspects of preparing, moving, fighting, and sustaining. He must be able to see his own tasks and enemy actions in relation to time. For example, he must be able to assess the impact of limited visibility conditions on the troop-leading procedures. He must know how long it takes under such conditions to prepare for certain tasks--such as order preparation, rehearsals, and backbriefs--and to complete other time-sensitive preparations for subordinate elements. He must understand how long it takes to deploy a support-by-fire element and determine the amount of ammunition that is needed to sustain the support for a specific period of time. He must know how long it takes to assemble a bangalore torpedo and to breach a wire obstacle. Most importantly, as events occur, he must adjust his appreciation of time available to him and assess its impact on

what he wants to accomplish. Finally, he must update previous timelines for his subordinates, listing all events that affect the unit and its subordinate elements. Figure 2-10 provides an example of a company timeline.

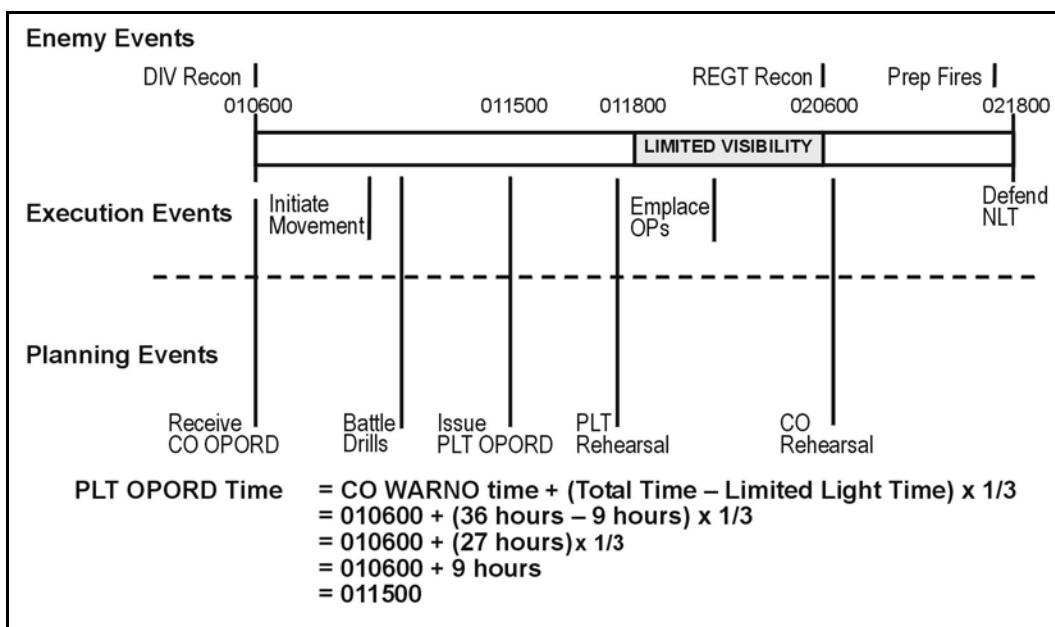

Figure 2-10. Example of a company timeline.

(6) *Civil Considerations.* The higher headquarters will provide the company commander (or platoon leader) with civil considerations that may affect the antiarmor company and or platoon missions. The company commander (or platoon leader) must also identify any civil consideration that may affect only his mission. These may include refugee movement, humanitarian assistance requirements, or specific requirements related to the rules of engagement (ROE) or rules of interaction (ROI).

(7) *Summary of Mission Analysis.* The end result of mission analysis is the development of a number of insights and conclusions regarding how the factors of METT-TC affect accomplishment of the unit's mission. From these insights and conclusions, the company commander (or platoon leader) derives a restated mission, an initial intent (only for a company commander), an initial risk assessment, and possibly a decisive point. He uses these to develop courses of action, which are possible ways to accomplish his mission.

(a) *Commander's Intent.* The commander's intent is a clear, concise statement of what the force must do to succeed with respect to the enemy, terrain, and desired end state. It provides the link between the mission and the concept of operations by stating the key tasks that, along with the mission, are the basis for subordinates to exercise disciplined initiative when unanticipated opportunities arise or when the original concept of operation no longer applies. Key tasks are those that must be performed by the unit or conditions that must be met to achieve the stated purpose of the operation. Key tasks are not tied to a specific course of action. They are not limited to "tactical tasks." The operation's tempo, duration and effect on the enemy, and the terrain that must be controlled, are examples of key tasks. The commander's intent does not include the

method by which the force will get from its current state to the end state. The method is the concept of operations. Nor does the intent contain "acceptable risk." Risk is addressed in courses of action. Figure 2-11 shows an example of key tasks related to enemy, terrain, and desired end state. An example of commander's intent follows.

Commander's Intent: *All enemy forces on OBJ ATLANTA destroyed; company controls west side of Bush Hill; company is in defensive posture NLT 121400XX able to defeat enemy CATK in EA RED; 52nd ID (M) passed through CP2 without significant delay.*

KEY TASKS IN RELATION TO--		
<p>Enemy:</p> <ul style="list-style-type: none"> • All enemy forces on OBJ ATLANTA destroyed. • Enemy forces fixed in EA DOG. • Enemy reconnaissance forces destroyed prior to reaching PL DOG. • Enemy unable to mass greater than two MRPs against BN ME. 	<p>Terrain:</p> <ul style="list-style-type: none"> • Company controls west side of Bush Hill NLT 231000 XX. • Major chokepoints along RT BLUE cleared of obstacles and enemy forces. • Company reaches PL DOG NLT 210600 XX. 	<p>Desired End State:</p> <p>Company in defensive posture NLT 121400 XX, able to destroy enemy counterattack in EA RED. 52 ID (M) passed through CP2 without significant delay.</p>

Figure 2-11. Example of key tasks.

(b) *Risk Assessment.* Risk assessment is the identification and assessment of hazards that allows a commander to implement measures to control hazards (refer to Appendix B). Identification and assessment are the first two steps of the risk management process. Risk management is conducted to protect the force and increase the chance of mission accomplishment. The leader must consider two types of risk: tactical and accident. Tactical risk is associated with hazards that exist due to the presence of the enemy on the battlefield. The consequences of tactical risk take two major forms:

- Enemy action in an area where the leader has accepted risk (such as an enemy attack where the friendly commander has chosen to conduct economy of force operations).
- Lost opportunity (such as moving across restricted terrain and then being unable to mass effects of combat power because of inability to traverse the terrain rapidly).

Accident risk includes all operational risk considerations other than tactical risk and can include activities associated with hazards concerning friendly personnel, equipment readiness, and environmental considerations. Fratricide and the inability to complete a planned air movement because of weather conditions are two examples of accident risk. The leader must identify risks based on the results of his mission analysis, decide which risks he is willing to accept, and incorporate measures that abolish or mitigate the consequences of the identified risks into his courses of action.

2-9. ISSUE A WARNING ORDER

After the company commander or platoon has determined his unit's mission and assessed the time available for planning, preparing for, and executing the mission, he should immediately issue a warning order to his subordinates. In addition to telling his subordinates of the unit's new mission, the warning order also gives them his planning timeline. He also may communicate any other instructions or information that he thinks will assist them in preparing for the new mission. This includes any information on the enemy and the nature of the higher headquarters' overall plan and any specific instructions or rehearsal tasks for preparing subordinate units for the mission. The most important thing is not to waste any time in issuing the initial warning order. If and when more information becomes available, he can--and should--issue additional warning orders. By issuing the initial warning order as quickly as possible, he enables his subordinates to begin their own planning and preparation (parallel planning) while he begins to develop the OPORD.

2-10. MAKE A TENTATIVE PLAN

In a time-constrained environment, a company commander (or platoon leader) typically will develop only one course of action; however, as time permits, he may develop as many COAs as possible to allow comparison. He will begin this step of the TLP after he issues his warning order and typically after he has received higher headquarters' third warning order. He does not need to wait for a complete OPORD before beginning his own COA development.

a. **COA Development.** The purpose of COA development is to determine one or more ways to accomplish the mission that are consistent with the immediate higher commander's intent. A COA describes how the unit might generate the effects of overwhelming combat power against the enemy at the decisive place with the least friendly casualties. Each COA the company commander (or platoon leader) develops must be detailed enough to clearly describe how he envisions using his antiarmor assets and combat multipliers to achieve the unit's mission-essential task and purpose. To develop a COA, he focuses on the actions the unit must take at the decisive point and works backward to his start point. He should develop several COAs, if time and the situation permit. A legitimate COA must be--

- Suitable. If successfully executed, the COA will accomplish the mission consistent with the higher commander's concept and intent.
- Feasible. The unit has the technical and tactical skills and resources to successfully accomplish the COA.
- Acceptable. The COA minimizes friendly casualties.
- Distinguishable. Each COA must be sufficiently different from the others to justify full development and consideration.
- Complete. The COA must cover the operational factors of *who*, *what*, *when*, *where*, and *how*, and address the mission from its start point to its conclusion.

The COA also must address the doctrinal aspects of the mission. For example, in the attack against a defending enemy, the COA must address the movement to, deployment against, assault of, and consolidation upon, the objective.

(1) **Analyze Relative Combat Power.** The purpose of this step is to compare combat power of friendly and enemy forces. It is not merely a calculation and comparison of

friendly and enemy weapons numbers or units with the aim of gaining a numerical advantage. Using the results of all previous analyses done during mission analysis, the company commander (or platoon leader) compares his unit's combat power strengths and weaknesses with those of the enemy. He seeks to calculate the time and manner in which his force (and the enemy) can maximize the effects of maneuver, firepower, protection, leadership, and information, in relation to the specific ground, disposition, and composition of each force. In short, he is trying to determine where, when, and how his unit's combat power (the effects of maneuver, firepower, protection, leadership, and information) can overwhelm the enemy's ability to generate combat power. Where and when this occurs is the decisive point. Using a matrix is one technique to assist in organizing his analysis (Figure 2-12). The matrix allows him to identify conclusions that he can apply to the development of his COA. The conclusions from his analysis of combat power are not COA specific, but rather apply to all COAs he may develop. Once he has completed his relative combat power analysis (RCPA), he attempts to determine a decisive point (if he has not done so already). He does this by considering the unit's mission, the terrain, and the enemy, seeking to find a place in time or space where he can focus overwhelming combat power to accomplish the unit's assigned purpose. He must understand the strengths and vulnerabilities of his unit and the enemy. The RCPA, as a tool, should lead him to a better understanding of when, where, and how to apply his combat power to exploit a weakness or relative weakness of the enemy. This process points the way to a potential decisive point, tactics, or techniques to be used when generating options.

Combat Power	Friendly Strengths	Enemy Weaknesses	Friendly Weaknesses	Enemy Strengths	Conclusions	Tactics Techniques
Maneuver						
Firepower						
Protections						
Leadership						
Information						

Figure 2-12. Relative combat power analysis (RCPA) matrix.

(2) *Generate Options.* The company commander (or platoon leader) first determines the doctrinal requirements for his particular operation. These also may include the doctrinal tasks to be assigned to subordinate units. For example, a breach requires an assault force, a support force, a breach force, and possibly a reserve. This doctrinal requirement provides a framework to develop a COA. Next he determines his decisive point. If he has not done so earlier in the TLP, he must determine his decisive point during this step in order to proceed. Once he has determined his decisive point, he identifies the main effort's purpose and the purposes of his supporting efforts. The main effort's purpose is nested to his unit's overall purpose and is achieved at his decisive point. The supporting efforts' purposes are nested to the main effort's purpose by setting

the conditions for success of the main effort. He then determines the mission-essential tactical tasks for the main and supporting efforts. These tasks are those that must be accomplished to achieve the subordinate units' given purposes.

(3) **Array Initial Forces.** He must then determine the specific quantity of weapons (by type) and fire support necessary to accomplish each task against the enemy array of forces (refer to Appendix C, Direct Fire Planning and Control). He must ensure that he has sufficient combat power to accomplish the assigned task. He allocates resources required for the main effort's success first and then determines the resources needed for supporting efforts in descending order of importance.

EXAMPLE: As the support force for an air assault infantry battalion attack of a strong point, the antiarmor company main effort (the support-by-fire force) may require eight MK19s and four M2 whereas the supporting efforts (isolating forces) may need four TOWs and four M2s. This array relies on an accurate assessment in step 1 (RCPA).

(4) **Develop Schemes of Maneuver.** The scheme of maneuver is a description of how the company commander (or platoon leader) envisions the COA unfolding from its start to its conclusion or end state. He clarifies in his mind the best ways to use the available terrain and to employ the unit's strengths against the enemy's weaknesses. He includes the requirements of indirect fire to support the maneuver. He then develops the maneuver control measures necessary to convey his intent, to enhance the understanding of the schemes of maneuver, to prevent fratricide, and to clarify the tasks and purposes of the main and supporting efforts. He also determines the CS and CSS aspects of the COA. As control measures become necessary, he places them on his maneuver overlay. This now becomes the basis for his COA sketch that he can distribute to his subordinates.

(5) **Assign Headquarters.** He assigns specific subordinate elements as the main and supporting efforts. He ensures that he has employed every unit in his command and that he has provided for adequate command and control of each element. He must avoid unnecessarily complicated command and control structures.

(6) **Prepare COA Statements and Sketches.** He bases the COA statement on the scheme of maneuver that he has already developed. It focuses on all significant actions from the start of the COA to its finish. His ability to prepare COA sketches and statements depends on the amount of time available as well as his skill and experience with antiarmor weapons systems. He should, whenever possible, prepare a sketch showing each COA. Another useful technique is to show the time it takes to achieve each movement and task in the COA sketch to gain an appreciation for the relative accumulation of time as the course of action is executed. The COA statement should state his decisive point and why it is decisive, the form of maneuver or the defensive technique, the tasks and purposes of his main and supporting efforts, the task and purpose of critical BOS elements, and an end state.

b. **COA Analysis.** After developing the COA, the antiarmor company commander (or platoon leader) analyzes it to determine its strengths and weaknesses; to visualize the flow of the battle; to identify the conditions or requirements necessary to enhance

synchronization; and, most significantly, to gain insights into actions at the decisive point and action of the mission. If he has developed more than one COA, he applies this same analysis to each COA developed. He does this analysis through war-gaming or "fighting" the COA against at least one enemy COA.

(1) **War-Gaming.** When time permits, he war-games each friendly COA against the most probable enemy COA. War-gaming, depending on how much time is devoted to it, provides the following:

- An appreciation for the time, space, and triggers needed to integrate fire support, smoke, engineers, air defense artillery, and nuclear, biological, and chemical (NBC) with maneuver platoons (antiarmor, infantry, or tank) to support unit tasks and purposes identified in the scheme of maneuver.
- Flexibility built into the plan by gaining insights into possible branches to the basic plan.
- The need for control measures (such as checkpoints, contact points, and TRPs) that facilitate control, flexibility, and synchronization.
- Coordinating instructions to enhance execution and unity of effort and to mitigate confusion between subordinate elements.
- Information needed to complete paragraphs 3, 4, and 5 of the OPORD.
- Assessments regarding on-order and be-prepared missions.
- Projected CSS expenditures, friendly casualties, and resulting medical requirements.

(2) **War-Gaming Techniques.** Depending on the time available and his personal preference, he may use any of the following war-gaming techniques--

(a) **Box Technique.** The box technique focuses the war game on a specific area of the battlefield. This may be the objective area, the engagement area, or some other critical location where decisive or critical actions will take place. It should include all of the units, friendly and enemy, that will have a direct impact on those actions. This technique is a good one to use when time is limited and the enemy situation is relatively clear. However, a key disadvantage of the box technique is that, when considering only the actions at the critical or decisive points, the company commander (or platoon leader) may overlook other actions or events that could have a significant impact on the unit's mission.

(b) **Belt Technique.** The belt technique allows him to divide the COA into events or belts. He may do this in several ways, such as from phase line to phase line or by significant event. Each step then is war-gamed in sequence. This approach is most effective for offensive COAs. The company commander (or platoon leader) can modify this technique by dividing the battlefield into belts that are not necessarily adjacent or overlapping but focus on the critical actions throughout the area of operations.

(c) **Avenue-in-Depth Technique.** This method is most effective for a defensive COA, especially when there are several avenues of approach to consider. Using the enemy's most probable COA, he analyzes friendly and enemy actions along one avenue of approach at a time.

(3) **War-Gaming Guidelines.** To gain the benefits that result from war-gaming a COA, the company commander (or platoon leader) must remain objective and record the results of the war game. He must remember the assumptions he made about the enemy, his unit, and the ground during the development of his tentative plan. He must avoid

letting the enemy or his unit “win” to justify the COA. Additionally, he must avoid drawing premature conclusions about the war game or making changes to his COA until the war game is complete.

c. **COA Comparison and Selection.** If the company commander (or platoon leader) has developed more than one COA, he must compare them by weighing the specific advantages, disadvantages, strengths, and weaknesses of each course as noted during the war game. These attributes may pertain to the accomplishment of the unit purpose, the use of terrain, the destruction of the enemy, or any other aspect of the operation that he believes is important. He uses these factors, gained from his RCPA matrix, as his frame of reference in tentatively selecting the best COA. He makes the final selection of a COA based on his own judgment, the start time of the operation, the area of operations, the scheme of maneuver, and subordinate unit tasks and purposes.

d. **Commander’s Critical Information Requirements.** The CCIR identify information needed by a commander to support his visualization and to make critical decisions, especially to determine or validate courses of action. They help him determine what is relevant to mission accomplishment. In one technique, he writes the desired question, the quantified answer, and the reaction (critical decision to make). CCIR also help focus the efforts of his subordinates and assist in the allocation of resources. CCIR should be kept to what is absolutely essential.

(1) **Priority Intelligence Requirements.** This is information that a commander needs to know about terrain or enemy in order to make a critical decision. PIR are best expressed in a question that can be answered with a “Yes” or “No.”

EXAMPLE: Can wheeled vehicles cross the creek at NU12345678? If yes, the antiarmor company will cross at this location. If no, the antiarmor company will move the vehicles along another route.

(2) **Friendly Forces Information Requirements (FFIR).** This is information that a commander needs to know about his unit or adjacent units to make a critical decision.

EXAMPLE: I want to know when we have lost one TOW because I will need to supplement the remaining direct fires weapons systems in the support element with additional mortar fires.

2-11. INITIATE MOVEMENT

The company commander (or platoon leader) initiates any movement necessary to continue mission preparation or to posture the unit for the start of the mission. This step can be executed at any time throughout the sequence of the TLP. This may include movement to an assembly area, a battle position, a new area of operation, or the movement of guides or quartering parties.

2-12. CONDUCT RECONNAISSANCE

In order to exploit the principles of speed and surprise, the company commander (or platoon leader) should weigh the advantage gained by personal reconnaissance versus the combat multiplier received in the form of supplied information. He may have the ability to plan his operation based upon the unprecedented amount of information provided by the other information collection sources. However, if time permits, he should verify higher headquarters' intelligence with visual reconnaissance. His reconnaissance should seek to confirm the PIR that support his tentative plan. These PIR are usually assumptions or critical facts concerning the enemy (his location, especially templated positions, and strength) and the terrain (verification, for example, that a tentative support-by-fire position actually will allow for suppression of the enemy or that an avenue of approach will be useable).

a. If possible, he should include his subordinate leaders in this reconnaissance. This allows them to see as much of the terrain and enemy as possible. The reconnaissance also helps subordinate leaders to gain insight into his visualization of the operation.

b. The leader's reconnaissance may include moving to or beyond the line of departure (LD) or walking from the forward edge of battle area (FEBA) back to and through the company sector or battle position along likely enemy avenues of approach. If possible, the company commander (or platoon leader) should select a vantage point that provides the group with the best possible view of the decisive point.

c. In addition to the leader's reconnaissance, the unit may conduct additional reconnaissance operations. Examples include surveillance of an area by subordinate elements, patrols by attached infantry squads to determine where the enemy is (and is not) located, and establishment of observation posts to gain additional information.

d. The nature of the reconnaissance, including what it covers and how long it lasts, depends on the tactical situation and the time available. The company commander (or platoon leader) should use the results of the COA development process to identify information and security requirements for the unit's reconnaissance operations.

2-13. COMPLETE THE PLAN

During this step, the company commander (or platoon leader) takes his selected COA and expands it into a complete OPORD. He prepares overlays, refines the indirect fire list, completes CSS and C2 requirements and, of course, updates the tentative plan based on the latest reconnaissance or information. He prepares a briefing site and other briefing materials he may need to present the OPORD directly to his subordinates. Finally, he makes final coordination with other units or staff members before issuing the order to his subordinates. The five-paragraph OPORD format helps him paint a complete picture of all aspects of the operation: terrain, enemy, higher and adjacent friendly units, unit mission, execution, support, and command and control. The format also assists him in addressing all relevant details of the operation. It provides subordinates with a smooth flow of information from beginning to end.

2-14. ISSUE THE OPORD

The OPORD precisely and concisely explains both his intent (company commander only) and concept of how he envisions the unit accomplishing the mission. The order does not

contain unnecessary information. Nice-to-know information clouds what is essential and important and often causes confusion and uncertainty.

a. When issuing the OPORD, he must ensure his subordinates understand and share his vision of what must be done and when and how it must be done. They must understand how all the unit's elements work together to accomplish the mission. They must also understand how the unit's mission supports the intentions of the immediate higher commander. When he has finished issuing the order, subordinate leaders should leave with a clear understanding of what the company commander expects their elements to do.

b. Additionally, and in many respects more importantly, the company commander (or platoon leader) must issue the order in a manner that imbues his subordinates with confidence in the plan and a commitment to do their best to achieve the plan. Whenever possible, he must issue the order in person, looking into the eyes of his soldiers to ensure each subordinate leader understands his mission and what his element must achieve.

c. Complete the order with an initial backbrief utilizing the initial warning order issued in step 2 of the TLP. Each subordinate leader should be able to backbrief the unit mission (and intent for antiarmor companies), the immediate higher commander's intent, his own task and purpose, and the time of his unit (platoon or section) OPORD.

2-15. SUPERVISE AND OR REFINE

This final step of the TLP is crucial. After issuing the OPORD, the company commander (or platoon leader) and his subordinate leaders must ensure that the required activities and tasks are completed in a timely manner prior to mission execution. Supervision is the primary responsibility of all leadership. It is imperative that both officers and NCOs check everything that is important for successful mission accomplishment. These include, but are not limited to--

- Listening to subordinate operation orders.
- Observing rehearsals of subordinate units.
- Checking load plans to ensure they are carrying only what is necessary for the mission.
- Checking the status and serviceability of weapons.
- Checking on maintenance activities of subordinate units.
- Ensuring local security is maintained.

CHAPTER 3 MOVEMENT

This chapter discusses some of the tools that antiarmor leaders exercise to command and control the movement of antiarmor units on the battlefield. The purpose of tactical movement is to move antiarmor units on the battlefield and prepare them for contact. The various techniques and formations have unique advantages and disadvantages. Some movement techniques are secure but slow, while others are fast but less secure. Some formations work well in certain types of terrain or tactical situations but are less effective in others. The commander must consider the overall movement plan (mounted and dismounted) to include where, when, and how he may transition between the two. None of the movement techniques or formations described in this chapter should be considered inflexible or immutable. The company commander must always be prepared to adapt them to the situation at hand.

3-1. MOVEMENT FUNDAMENTALS

Movement must not be confused with maneuver. Maneuver is conducted while in contact, supported by fire, to gain a position of advantage over the enemy. Tactical movement, however, is conducted in preparation for contact. At the company and platoon level there is considerable overlap between the two, and units transition from one to the other during “actions on contact.” Antiarmor units must reduce their exposure to the enemy during movement. They accomplish this by use of the terrain, avoidance of possible kill zones, dispersion, reconnaissance, and the use of measures to counter enemy observation and fires.

NOTE: The antiarmor company commander in an SBCT uses these fundamentals, augmented by the capabilities of FBCB2 and his knowledge of the art of war, to produce his situational understanding.

a. **Use Terrain for Protection.** Terrain offers cover and concealment from observation and fires. Terrain driving techniques can help units use the terrain over which they move to their advantage. Drivers should avoid “skylining.” They should not move directly forward from a defilade firing position, and they should cross open areas quickly.

b. **Avoid Possible Kill Zones.** Units should avoid large open areas surrounded by cover and concealment or those dominated by terrain. They watch for the presence of obstacles or any other signs of an engagement area.

c. **Dispersion.** Dispersion between vehicles and units prevents units from becoming fixed by one enemy position or weapons systems. It also prevents enemy artillery or mortar fires from suppressing the entire element.

d. **Observe.** Units assign responsibilities of observation to crews in the formation. Units scan their assigned sectors and assign internal scanning responsibilities to their crews. This observation reduces the chances of the enemy surprising the unit.

e. **Move During Limited Visibility.** Movement during darkness or other limited visibility conditions provides concealment from enemy gunners at long range.

NOTE: This chapter focuses on the movement techniques, formations, and dismounted transition points that, in combination with available FBCB2 technology, provide the company commander with options for moving his unit.

f. **Use Countermeasures.** Units increase their survivability by using countermeasures such as suppressive fires, smoke, and camouflage.

(1) **Suppressive Fires.** The antiarmor platoon uses direct and indirect fires to suppress enemy positions. Direct fire is the most responsive means of suppressing enemy weapons systems. Its effectiveness, however, varies according to the weapon being used to provide suppression. The TOW, while the most lethal choice against enemy armor, has a slow rate of fire. The MK19 and M2 (cal. 50 MG) can effectively suppress enemy positions out to 3,000 meters. The combination of TOW, MK19, and M2 may provide the best balance in unclear situations. The most effective means of suppression is indirect fire. Indirect fire can suppress enemy positions at greater ranges and is effective when the enemy is using masking terrain as protection. The battalion's organic mortars are the most responsive indirect fire assets available to antiarmor units in light, airborne, and air assault battalions.

(2) **Smoke.** Artillery, the maneuver battalion's organic mortars, smoke pots, and light vehicle obscuration smoke system (LVOSS) provide obscuration in support of maneuvering antiarmor units. The smoke denies the enemy's ability to observe and effectively target the antiarmor unit. Another benefit is the ability of the TOW thermal sight to see and acquire enemy targets through the smoke while concealed. The new thermal weapons sight for the MK19 and M2 make these weapons systems more effective when operating in smoke.

(3) **Camouflage.** Properly selected camouflage patterns and the masking of objects that shine complicate the enemy's ability to detect targets. Leaders take precautions to ensure windshields, mirrors, headlights, and other reflective surfaces do not compromise the vehicle's position at long range. For example, use tape or burlap sandbags to cover reflective surfaces or, when appropriate, remove those items not needed in a tactical environment.

3-2. MOVEMENT FORMATIONS

Formations are arrangements of elements, vehicles, and soldiers in relation to one another. Formations are not rigid, and the distances between vehicles, shape, and speed of the formation are determined by the factors of METT-TC. Each vehicle in the formation scans an assigned sector to ensure all-round security while moving. Antiarmor units use formation to--

- Establish the relationship of one subordinate unit to another on the ground.
- Allow the unit to position firepower where it is needed in support of a direct fire plan (see Appendix C, Direct Fire Planning and Control).
- Establish responsibilities for sector security among subordinate units.
- Facilitate the execution of battle drills and directed COAs.

a. **Column.** The column formation (Figure 3-1) is used when speed is critical, when the unit is moving through restricted terrain on a specific route, and when enemy contact is unlikely. Each subordinate unit follows directly behind the one in front of it. If the situation dictates, vehicles can disperse laterally to enhance security. The column formation has the following characteristics, advantages, disadvantages, and limitations:

- It is the easiest formation to control.
- It provides good security by maximizing firepower to the flanks.
- It permits rapid transition into other combat formations.
- It focuses on speed.
- It masks direct fires to the front.
- It provides limited overall security.

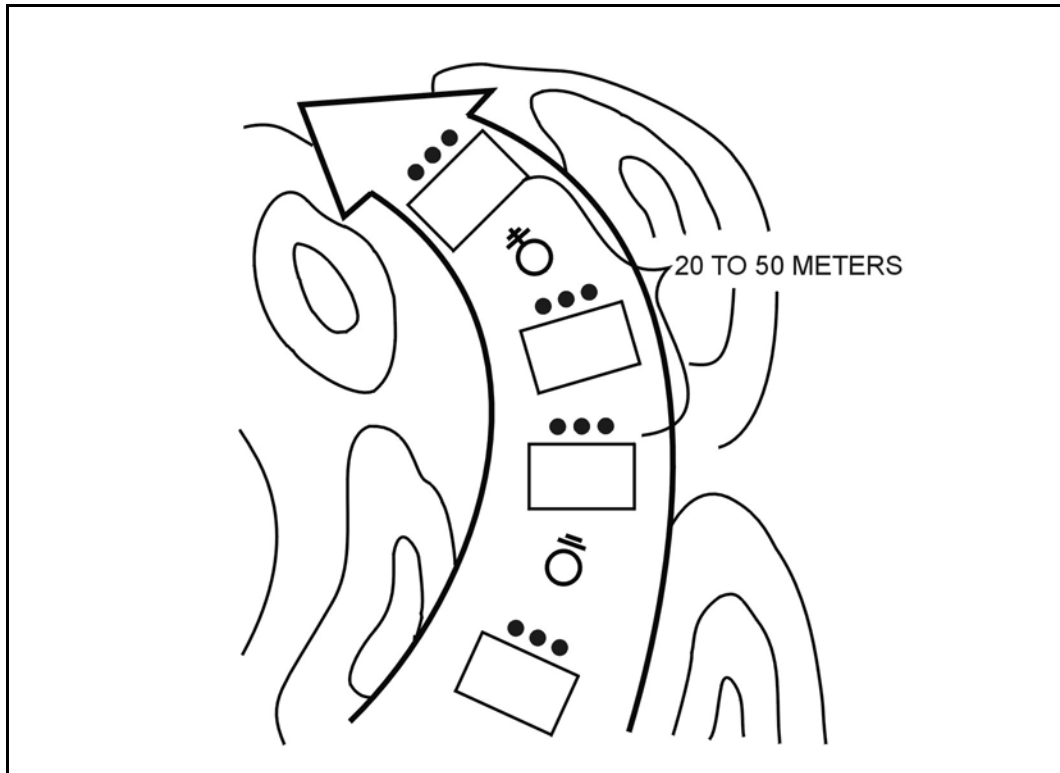

Figure 3-1. Column formation.

b. **Line.** The line formation (Figure 3-2, page 3-4) is used when a unit is crossing large open areas or needs to maximize firepower to the front. In the company line formation, platoons move abreast of one another and are dispersed laterally. The line formation has the following characteristics, advantages, disadvantages, and limitations:

- It provides maximum firepower to the front and rear, but minimum firepower to the flanks.
- It is difficult to control.
- It is less secure than other formations because it lacks depth.
- It is the most difficult formation from which to transition to other formations.

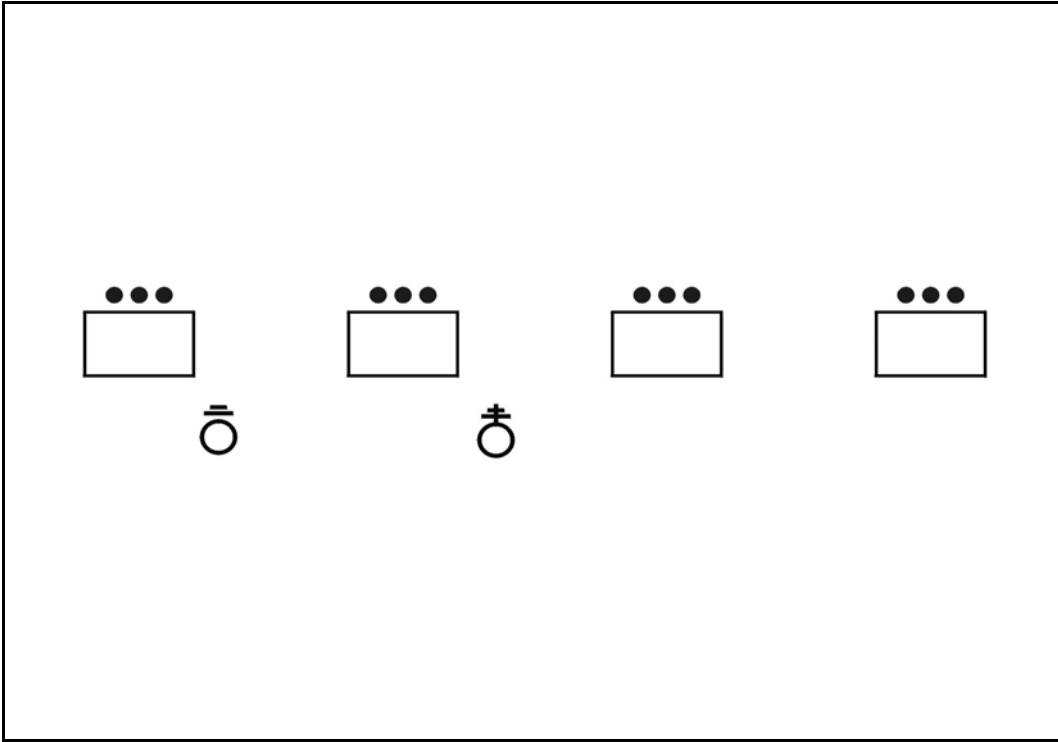

Figure 3-2. Line formation.

c. **Echelon.** The echelon formation (Figure 3-3) is used when the unit wants to maintain security or observation of one flank and enemy contact is unlikely. In the company echelon formation (left or right), the lead platoon positions farthest from the echeloned flank, with each subsequent platoon located to the rear of and outside the platoon in front of it. The echelon formation has the following characteristics, advantages, disadvantages, and limitations:

- It provides excellent security to the higher formation in the direction of the echelon.
- It allows for quick deployment in the direction of the echelon.
- It is difficult to control, especially in restrictive terrain.

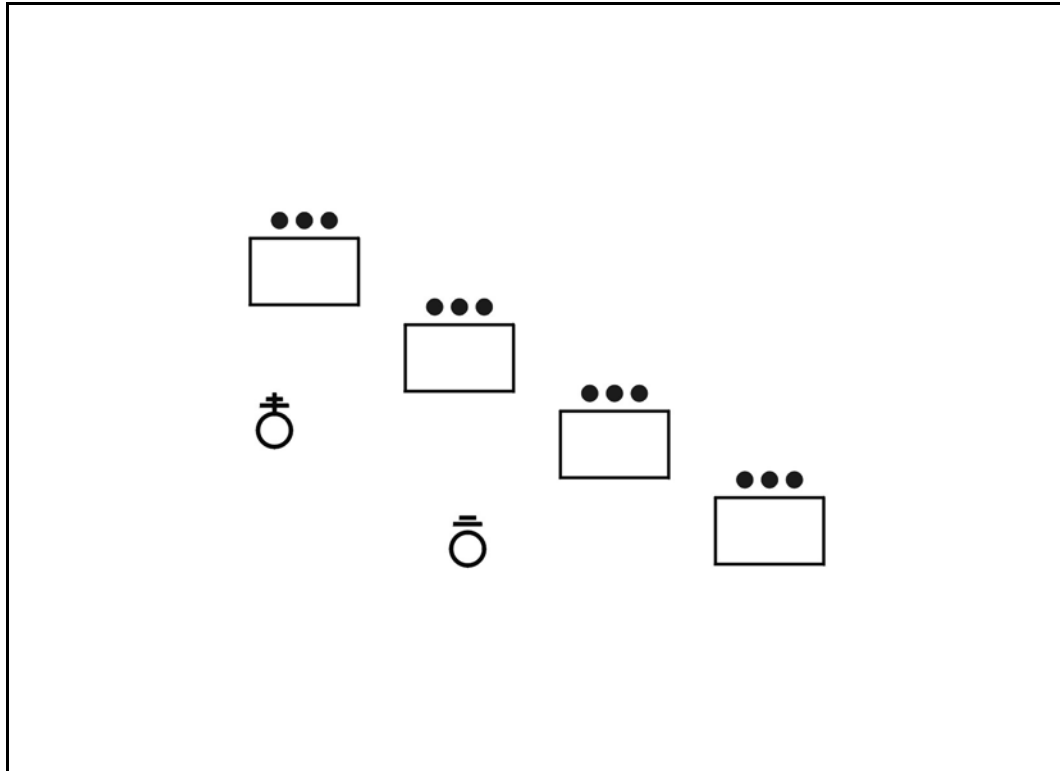

Figure 3-3. Echelon formation.

d. **Wedge.** The wedge formation (Figure 3-4, page 3-6) is used when the enemy situation is vague or contact is possible. In the company wedge, the lead platoon is in the center of the formation with the remaining platoons located to the rear of and outside the lead platoon. The wedge formation has the following characteristics, advantages, disadvantages, and limitations:

- It provides excellent firepower to the front while still maintaining good firepower to the flanks.
- It is easy to control.
- It provides good flank security.
- It can be used with all of the movement techniques.

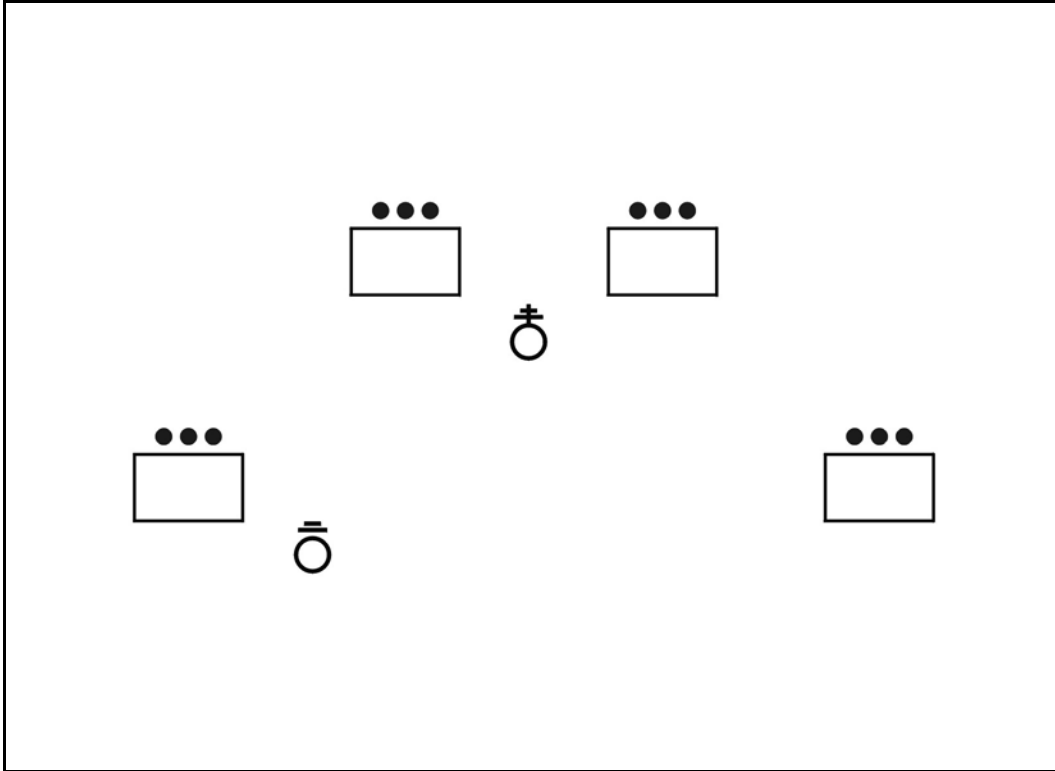

Figure 3-4. Wedge formation.

e. **Vee.** The vee formation (Figure 3-5) is used when enemy contact is possible. In the company vee, the center platoon is located at the rear of the formation, while the remaining platoons are located to the front of and outside the center platoon. The vee formation has the following characteristics, advantages, disadvantages, and limitations:

- It provides more firepower to the front than the wedge formation while still maintaining good firepower to the flanks.
- It allows one subordinate unit in the formation to maintain flexibility when contact occurs.
- It facilitates rapid deployment into other formations.
- It can be used with all of the movement techniques.
- It is more difficult to control than the wedge formation. It is difficult for individual vehicles to maintain proper orientation.

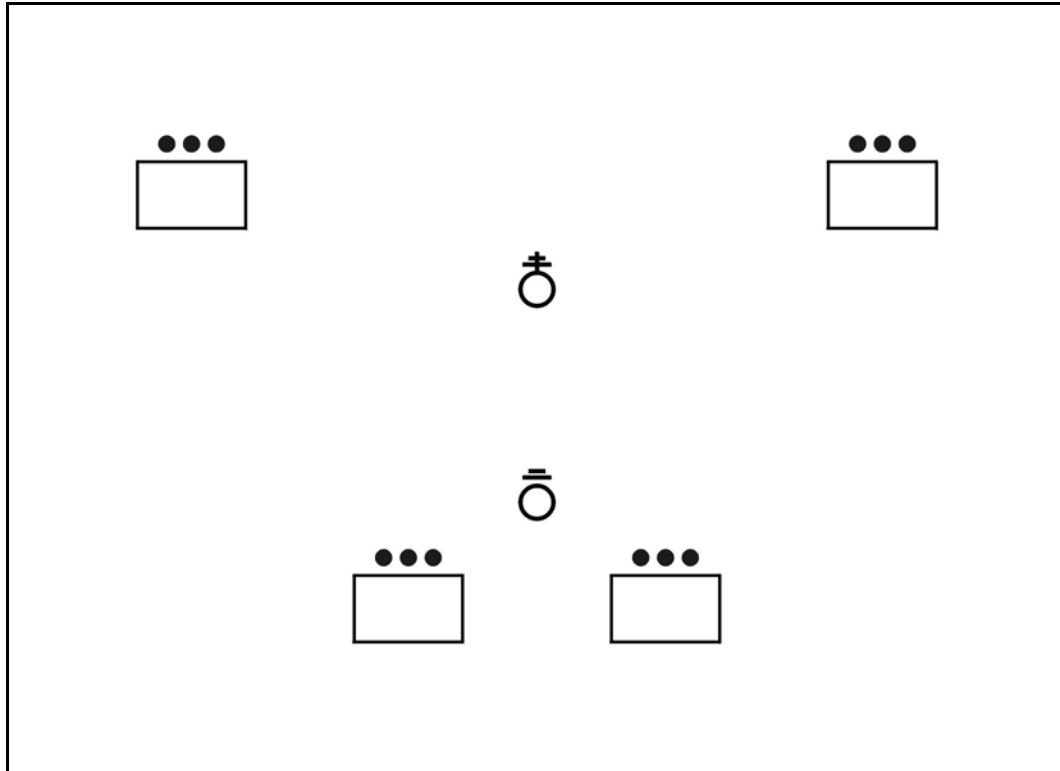

Figure 3-5. Vee formation.

f. **Coil and Herringbone.** The coil (Figure 3-6, page 3-8) and herringbone (Figure 3-7, page 3-8) are platoon-level formations employed when elements of the company are stationary and must maintain all around security.

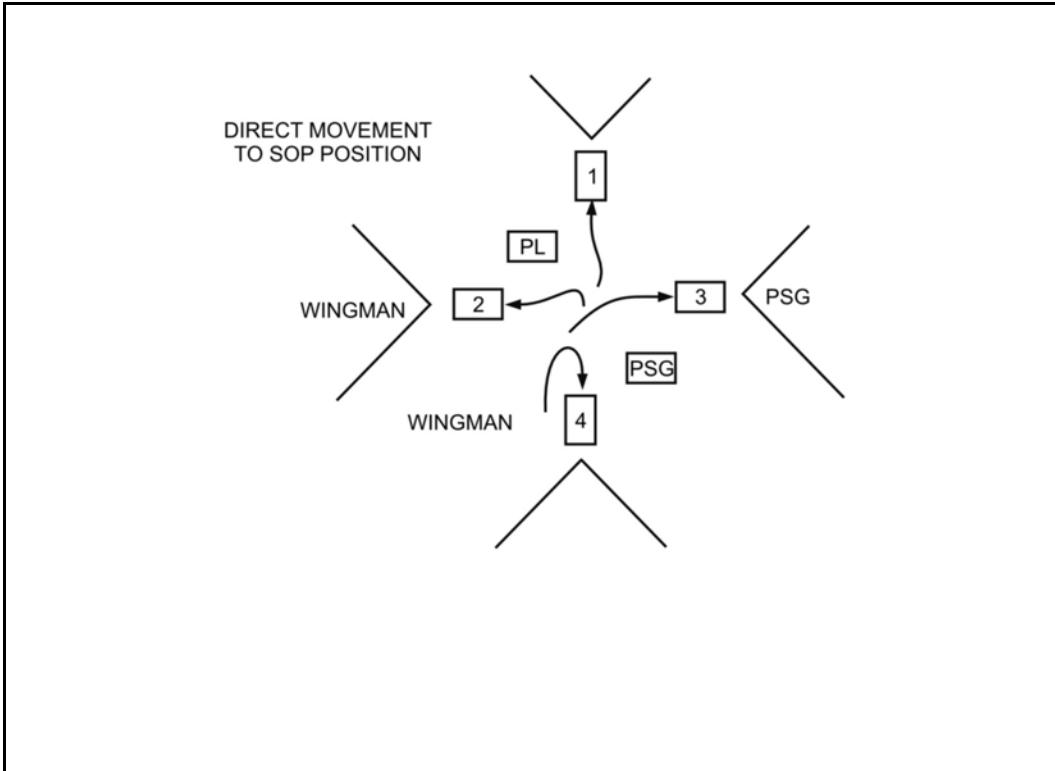

Figure 3-6. Coil formation

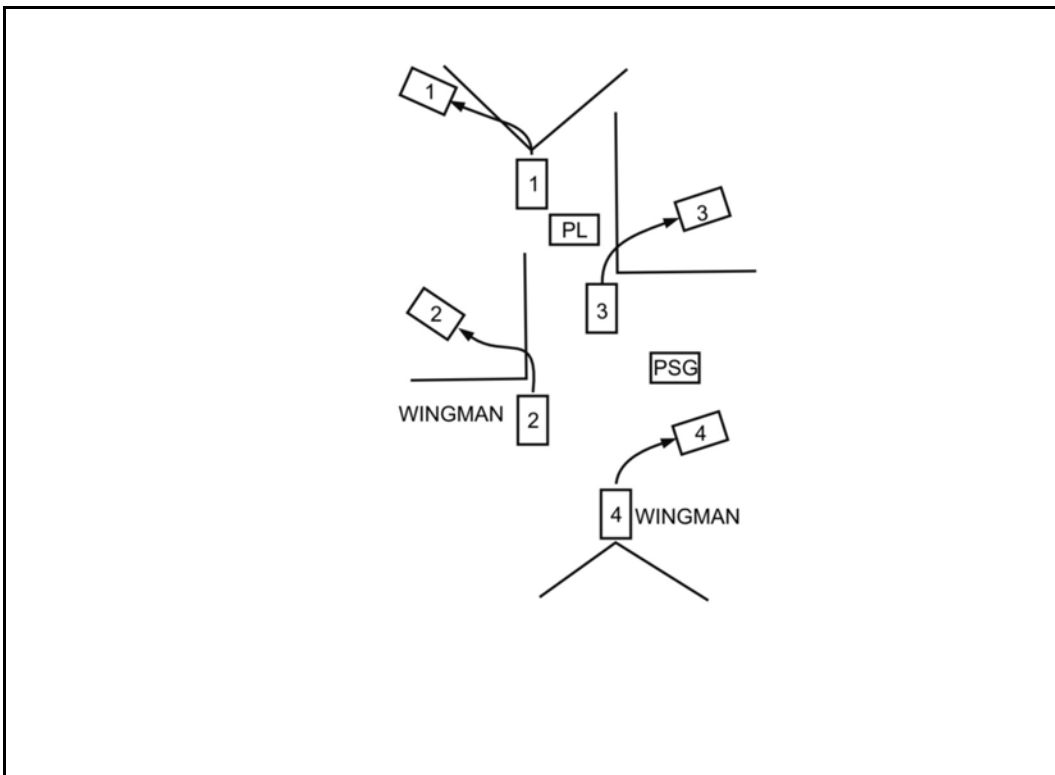

Figure 3-7. Herringbone formation.

3-3. MOVEMENT TECHNIQUES

A movement technique is the manner in which a unit traverses terrain, and it is determined by the likelihood of enemy contact. Antiarmor companies and platoons use the same basic movement techniques used by all ground maneuver units: traveling, traveling overwatch, and bounding overwatch. The antiarmor leader's detailed analysis of the factors of METT-TC (specifically the type of enemy contact expected, the availability of an overwatch element, the terrain over which the moving element will pass, and the balance of speed and security) dictates the movement technique employed.

a. **Traveling.** Continuous movement of all of the unit's elements characterizes the traveling movement technique (Figure 3-8). It is used when enemy contact is unlikely and speed is important.

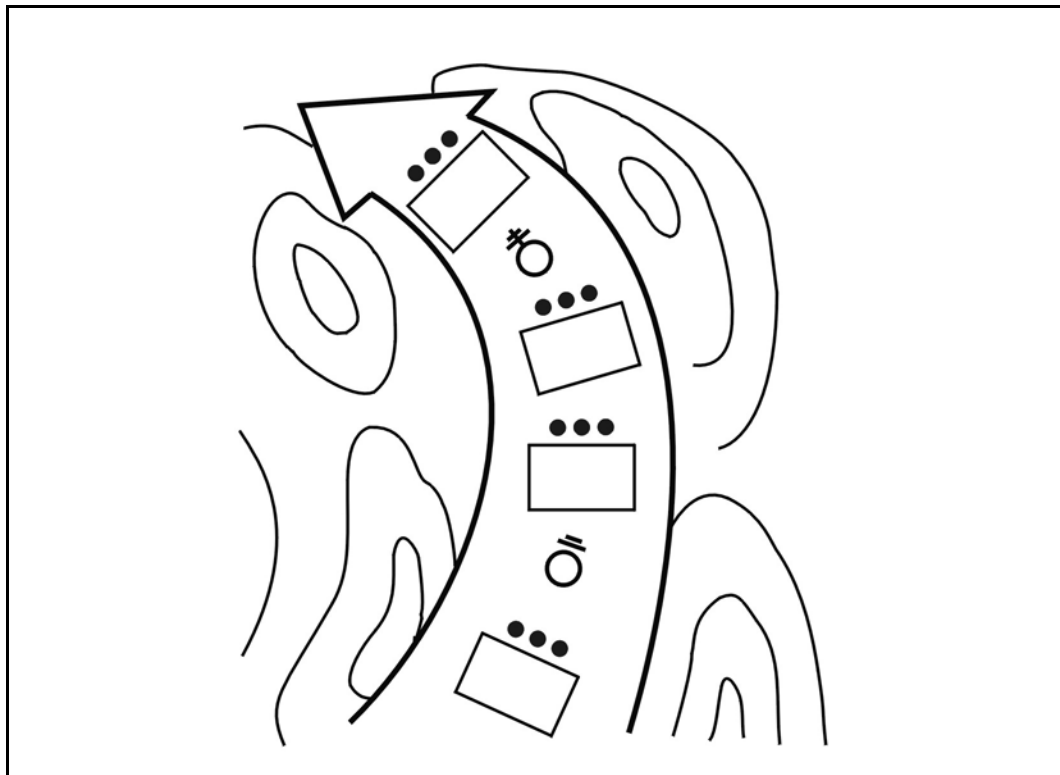

Figure 3-8. Traveling technique.

b. **Traveling Overwatch.** The traveling overwatch technique (Figure 3-9, page 3-10) is an extended form of the traveling technique that provides additional security when speed is desirable but enemy contact is possible. The lead element moves continuously. The trail element moves at various speeds and may halt periodically to overwatch the lead element's movement. The dispersion between the lead and trail elements must be based on the trail element's ability to provide immediate suppressive fires in case the lead element is engaged. The intent of the traveling overwatch technique is to maintain depth, provide flexibility, and maintain the ability to maneuver even if contact occurs.

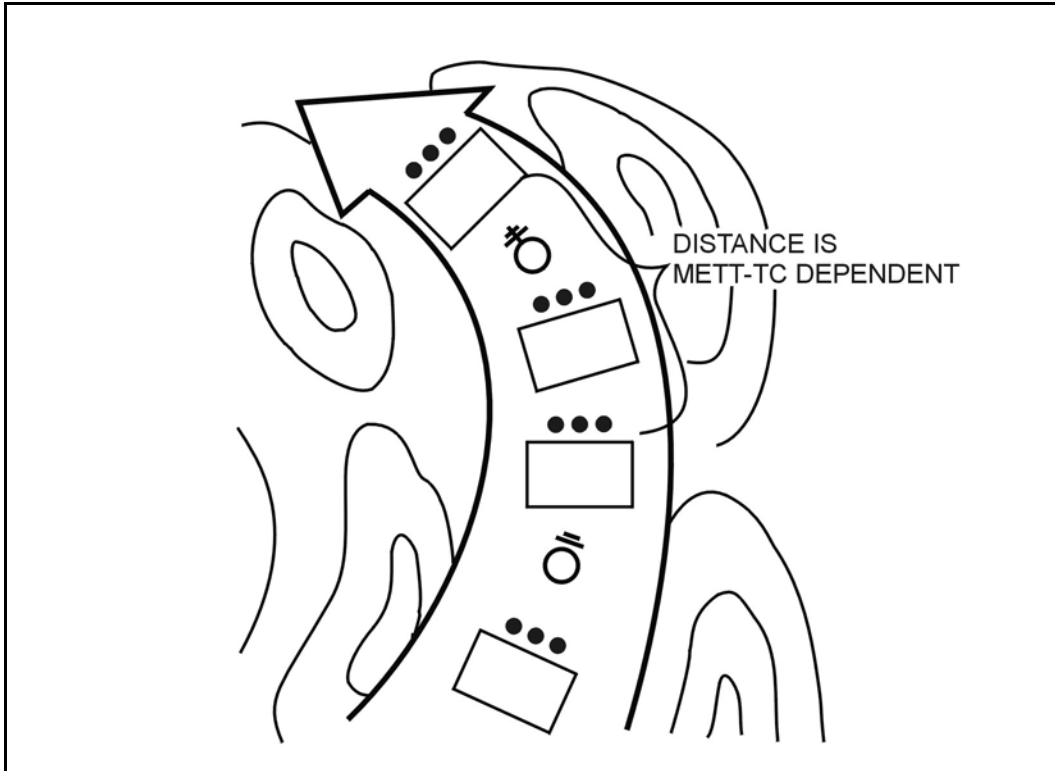

Figure 3-9. Traveling overwatch.

c. **Bounding Overwatch.** The bounding overwatch technique (Figure 3-10) is used when enemy contact is expected. The intent of this technique is for the unit to deploy prior to contact, giving it the ability to protect the bounding element by immediately suppressing an enemy force. When using the bounding overwatch technique, the overwatch element is assigned sectors to scan (see Appendix C, Direct Fire Planning and Control) while the bounding element moves. The bounding element should avoid masking the direct fires of the overwatch element, and it must not move beyond the effective supporting range of the overwatch element. Antiarmor units employ either of the two bounding methods: alternate bounds and successive bounds.

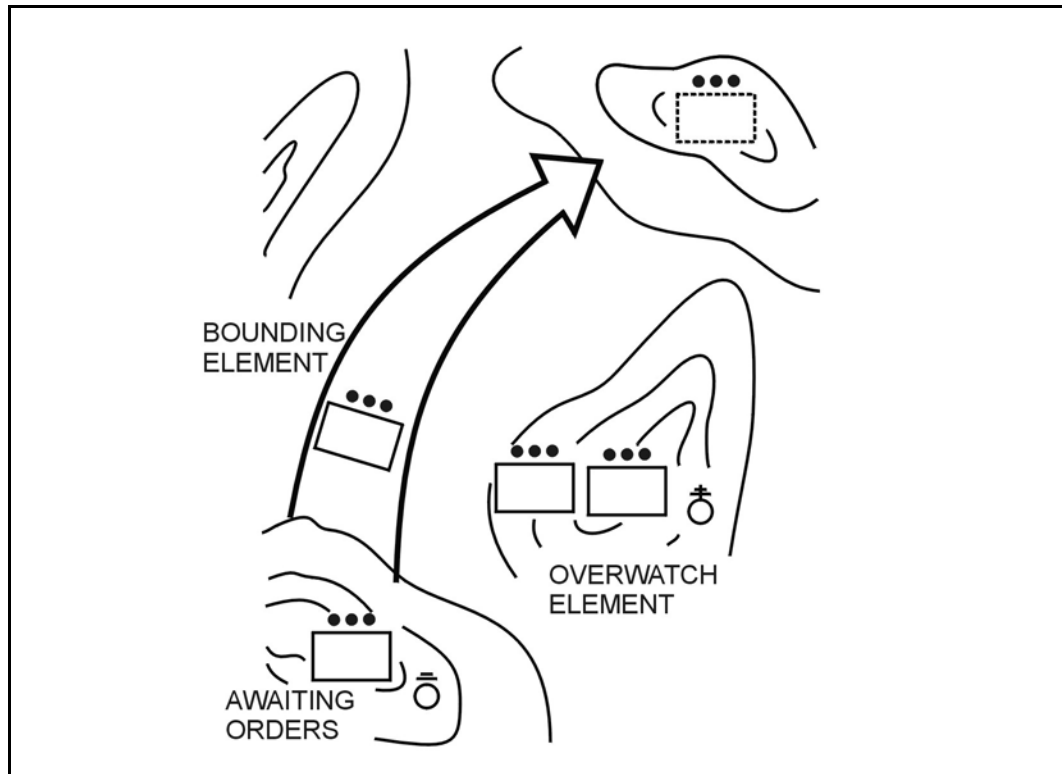

Figure 3-10. Bounding overwatch.

(1) ***Alternate Bounds.*** Covered by the trail element, the lead element moves forward, halts, and assumes an overwatch position. The trail element then advances past the lead element to assume an overwatch position. This sequence continues as necessary with only one element moving at a time. Alternate bounding is the more rapid of the two methods.

(2) ***Successive Bounds.*** The lead element, covered by the trail element, moves forward, halts, and assumes an overwatch position. The trail element then advances to an overwatch position that is roughly abreast of the lead element's position. The lead element then advances to the next position. This sequence continues as necessary with only one element moving at a time. The trail element avoids advancing past the lead element. Successive bounding is the more secure and easier to control of the two methods; however, it is much more deliberate and slower than alternate bounding.

CHAPTER 4

OFFENSIVE OPERATIONS

The offense is the decisive form of war. Offensive operations aim at destroying or defeating an enemy. The offense presents the greatest challenge in the employment of the antiarmor company and platoon. This challenge is compounded because airborne, air assault and light infantry battalions and Stryker brigade combat teams typically will operate in noncontiguous environments. The antiarmor company (or platoon) possesses the greatest firepower (TOW, M2, and MK19) and mobility (HMMWV or ICV) available to the parent organization. In the offense, these units provide tank-killing, bunker-destroying, and suppression capabilities that can influence the outcome of the operations. This chapter describes the tactics and techniques used by antiarmor companies and platoons in the movement to contact and in an attack.

Section I. GENERAL PLANNING CONSIDERATIONS

The outcome of decisive combat derives from offensive actions. All operations are designed to transition to and support the offense. A sound doctrinal foundation during offensive planning assists the antiarmor company commander (or platoon leader) in capitalizing on the increased tactical flexibility of his unit.

4-1. PURPOSE OF THE OFFENSE

Offensive operations seek to seize, retain, and exploit the initiative to decisively defeat the enemy. Additionally, offensive operations accomplish the following:

- Disrupt enemy coherence.
- Secure terrain.
- Deny the enemy of resources.
- Fix the enemy.
- Gain information.
- Deceive the enemy.

4-2. CHARACTERISTICS OF THE OFFENSE

Surprise, concentration, tempo, and audacity characterize the offense. The company commander (or platoon leader) does not use these as a checklist to conduct successful offensive operations; rather, he must ensure that his offensive plan incorporates the spirit of these characteristics.

a. **Surprise.** Units achieve surprise by striking the enemy at a time, at a place, or in a manner for which he is unprepared. Total surprise is rarely essential; simply delaying or disrupting the enemy's reaction is usually effective.

(1) Surprise delays the enemy's reactions, stresses his command and control, and induces psychological shock in his soldiers and leaders. This may allow an attacker to succeed with fewer forces than he might otherwise require.

(2) A unit's abilities to attack during limited visibility, to operate in small units, and to infiltrate are often key to achieving surprise. The company (or platoon) must exploit the

effect of surprise on the enemy before he can recover.

b. **Concentration.** The attacker concentrates combat power at the decisive point to achieve the unit's purpose. Leaders strive to concentrate the effects of their combat power without concentrating forces.

(1) Because the attacker is often moving across terrain the enemy has prepared, he may be exposing himself to the enemy's fires. By concentrating overwhelming combat power, the attacker can reduce both the effectiveness of enemy fires and the amount of time he is exposed to these fires.

(2) The challenge for the company commander (or platoon leader) is to concentrate combat power while reducing the enemy's ability to do the same against his unit. Actions that cause the enemy to shift combat potential away from the decisive point result in a greater advantage in combat power at the decisive point. The company commander (or platoon leader) must consider all of his available weapons systems (such as TOW, M2, and MK19) to achieve overwhelming combat power at the decisive point.

c. **Tempo.** Tempo is the rate of speed of military action. Controlling or altering that rate is essential for maintaining the initiative. Speed promotes surprise, keeps the enemy off balance, contributes to the security of the attacking force, and prevents the defender from taking effective countermeasures.

(1) Properly exploited, speed confuses and immobilizes the defender until the attack becomes unstoppable. Speed is built into operations through careful planning.

(2) The company (or platoon) increases its speed through its ability to transition rapidly from movement to maneuver by using simple plans, decentralized control, and mission orders. Speed of movement depends on reconnaissance, using proper movement formations and techniques, and selecting good routes for mounted movement. Antiarmor units develop SOPs to facilitate their transition from movement to maneuver.

d. **Audacity.** Audacity is the willingness to risk bold action to achieve positive results. The audacious leader develops confidence by conducting a thorough analysis of the factors of METT-TC. His actions, although quick and decisive, are based on a reasoned approach to the tactical situation and on his knowledge of his soldiers, the enemy, and the terrain. He is daring and original, but he is not rash.

(1) Audacious commanders throughout history have used the "indirect approach." They maneuver to maintain a position of advantage over the enemy, seek to attack the enemy on the flank or rear, and exploit success at once, even if this briefly exposes their own flanks.

(2) Boldness and calculated risk have always been the keystones of successful offensive operations. They must, however, be consistent with the higher commander's mission and intent.

4-3. CONSIDERATION OF SELECTED BATTLEFIELD OPERATING SYSTEMS

The following paragraphs describe factors the antiarmor company commander (or platoon leader) must consider for the employment of specific battle operating systems, including fire support, air defense, mobility and survivability, and combat service support.

a. **Fire Support.** As part of the top-down fire planning system, the company commander (or platoon leader) must refine the fire plan from higher headquarters to meet his mission requirements. He incorporates the results of his METT-TC analysis and makes key locations and targets from the fire plan an integral part of his rehearsal. Additionally, he

works with the battalion fire support officer (FSO) to develop a corresponding observation plan and triggers for initiating or shifting fires. The SBCT antiarmor company has an organic FIST and will coordinate all fire planning through the company FSO. The company commander (or platoon leader) and the FSO must have a thorough understanding of organic and supporting fire support elements. The majority of the unit's fire support in an airborne, air assault, and light infantry battalion will be from mortar systems organic to the battalion. The company commander (or platoon leader) employs supporting fires in the offense to achieve a variety of operational goals:

- Suppress enemy weapons systems that inhibit movement.
- Fix or neutralize bypassed enemy elements.
- Prepare enemy positions for an assault.
- Obscure enemy observation or screen friendly maneuver. The unit can take advantage of smoke in various maneuver situations, such as during a bypass or in deception operations.
- Illuminate enemy positions. Include illumination fires in contingency plans for limited visibility attacks.

b. **Air Defense.** Mounted Stinger sections may be attached with organic vehicle support to travel with the antiarmor company (or platoon). Their security must be a consideration in planning for offensive operations. The leader must plan for and rehearse internal air security and active air defense measures. SOP normally dictates air defense requirements and procedures. The leader also must anticipate possible contact with enemy air assets by determining likely enemy helicopter and fixed-wing air corridors and avenues of approach.

c. **Mobility and Survivability.** The higher headquarters may task-organize the company with engineers as part of an in-stride breach during the offense. The company commander (or platoon leader) normally receives additional mobility assets, such as engineers. If the antiarmor unit is attached to mechanized forces, it can receive equipment suited for mounted mobility such as a mine clearing line charge (MICLIC), an armored combat earthmover (ACE), or an armored vehicle-launched bridge (AVLB) based on an analysis of the factors of METT-TC. (FM 3-34.2 [90-13-1] and FM 90-7 provide more detailed discussions of mobility and survivability operations and support.).

d. **Combat Service Support.** The main purpose of CSS in the offense is to assist maneuver elements in maintaining the momentum of the attack. Key CSS planning considerations for antiarmor company (or platoon) offensive operations include the following:

- Increased consumption of Class III supplies.
- Vehicle maintenance requirements.
- Casualty evacuation.

In the offense, CSS functions are performed as far forward as the tactical situation permits. The company trains remain one terrain feature (or a relative distance based upon the factors of METT-TC) behind the location of the vehicles (HMMWV or ICV). The company commander must consider the enemy situation and how it relates to the security of the company trains. If the company is conducting decentralized operations, the company trains are located where they can best support the platoons in the accomplishment of the company's mission. CSS functions for the antiarmor platoons (light infantry battalions only) are typically performed by the battalion combat trains command post (CTCP) or the infantry

company to which the platoon is attached. If attached to an infantry company, the antiarmor platoon leader must express the importance of the three key CSS planning considerations to that company commander.

4-4. SEQUENCE OF OFFENSIVE OPERATIONS

As the company commander (or platoon leader) plans an offensive mission, he generally considers the following sequence of events that applies to many, but not all, offensive operations.

a. **Assembly Area.** He directs and supervises mission preparations in the assembly area to prepare the unit for the upcoming battle. Preparation time also allows the unit to conduct pre-combat inspections and checks, rehearsals at all levels, and CSS activities.

b. **Reconnaissance.** Reconnaissance should be conducted at all echelons. The enemy situation and available planning time may limit the unit's reconnaissance, but leaders at every level must aggressively seek information about the terrain and enemy. The "on-the-ground" antiarmor company (or platoon) reconnaissance effort reports on enemy activity near the line of departure, attack position (ATK PSN), assault position (ASLT PSN), or the unit's assigned objective (OBJ). This reconnaissance provides the antiarmor leader the information needed to execute the best possible tactical plan.

NOTE: In digitally equipped units, this information may be available via FBCB2; however, leaders must never forget the benefit of having patrols and leaders on the ground to the front of the maneuver force.

c. **Movement to the Line of Departure.** When attacking from positions not in contact, the antiarmor company (or platoon) often stages in rear assembly areas, road marches to attack positions behind friendly units in contact with the enemy, conducts forward passage of lines, and moves to the AO. When necessary, the unit employs indirect fires, close air support (when available), and direct fire to facilitate movement.

d. **Maneuver.** The antiarmor company commander (or platoon leader) plans the approach to the objective to ensure security, speed, and flexibility. He selects the routes, techniques, and formations that best support actions on the objective. All leaders must recognize this portion of the battle as a fight, not a movement. The unit may need to overcome enemy resistance en route to the objective and should plan accordingly. When possible, the company commander (or platoon leader) employs those techniques that avoid the enemy's strength and conceal his unit's true intentions. He deceives the enemy as to the location of the main effort, uses surprise to take advantage of his initiative in determining the time and place of his attack, and uses indirect approaches, when available, to strike the enemy from a flank or the rear.

e. **Deployment.** As a unit deploys and moves toward the ASLT PSN, it begins the final positioning of its forces so it can pass through the ASLT PSN with minimum delay and confusion. This tactical positioning allows units the opportunity to continue to "flow" the force in its best tactical posture through the assault position to begin the attack. Movement should be as rapid as the terrain, force mobility, and enemy situation will permit. The probable line of deployment (PLD) is the next control measure following the ASLT PSN. This is where the force fully commits to the attack.

f. **Assault.** During an offensive operation, the unit's objective may be terrain- or force-oriented. Terrain-oriented objectives require the unit to secure and retain a designated area and often require fighting through enemy forces. If the objective is force-oriented, an objective area may be assigned for orientation, but the unit's effort is focused on the enemy's actual disposition. The enemy may be a stationary or moving force. Actions on the objective start when the unit begins placing fires on the objective. This normally occurs with preparatory indirect fires while the unit approaches the objective. Preparatory fires are normally used during a deliberate attack, with fires placed on key targets before the assault begins. Fires are initiated on call or at a prearranged time. The commander must weigh the benefits of preparatory fires against the potential loss of surprise. The unit reorganizes and consolidates as required by the situation and mission.

g. **Consolidation and Reorganization.** The company (or platoon) executes follow-on missions as directed by the higher commander. Whether a raid, hasty attack, or deliberate attack, the unit must posture itself and prepare for continued offensive operations.

4-5. FORMS OF MANEUVER

In a typical sequence for an offensive operation, the company (or platoon) maneuvers against its adversary in the objective area. Maneuver places the enemy at a disadvantage through the application of friendly fires and movement. Properly executed, maneuver allows units to move on the battlefield while in contact. At the same time, maneuver allows a unit to advance, while in contact, to reach the point on the battlefield from which it executes its next tactical task. Maneuver is an integral part of tactical tasks, all of which require the combination of fire and movement. The five forms of maneuver--penetration, envelopment, turning movement, frontal attack, and infiltration--describe the positional relationships of opposing forces to attacking forces. In every attack, the company commander (or platoon leader) must determine how to maneuver his unit to get overwhelming combat power at the decisive point. He applies the basic forms of maneuver, individually or in combination, to do this. Regardless of the size of the enemy, the forms of maneuver remain unchanged. Reconnaissance is the key to selecting the proper form of maneuver. Once the maneuver is initiated, surprise, speed, and stealth are crucial to the unit's security and to preventing an effective counterattack. FM 3-0 and FM 3-90 provide greater detail on the forms of maneuver.

a. **Penetration.** Penetration is used when enemy flanks are not assailable and when time does not permit some other form of maneuver. Its purpose is to rupture enemy defenses on a narrow front and thereby create both assailable flanks and access to the enemy's rear (Figure 4-1, page 4-6). The company (or platoon) will normally conduct this as part of a larger force. Penetration may be tried at one or several points, depending on the forces available. However, a single unit usually focuses combat power at one breach point.

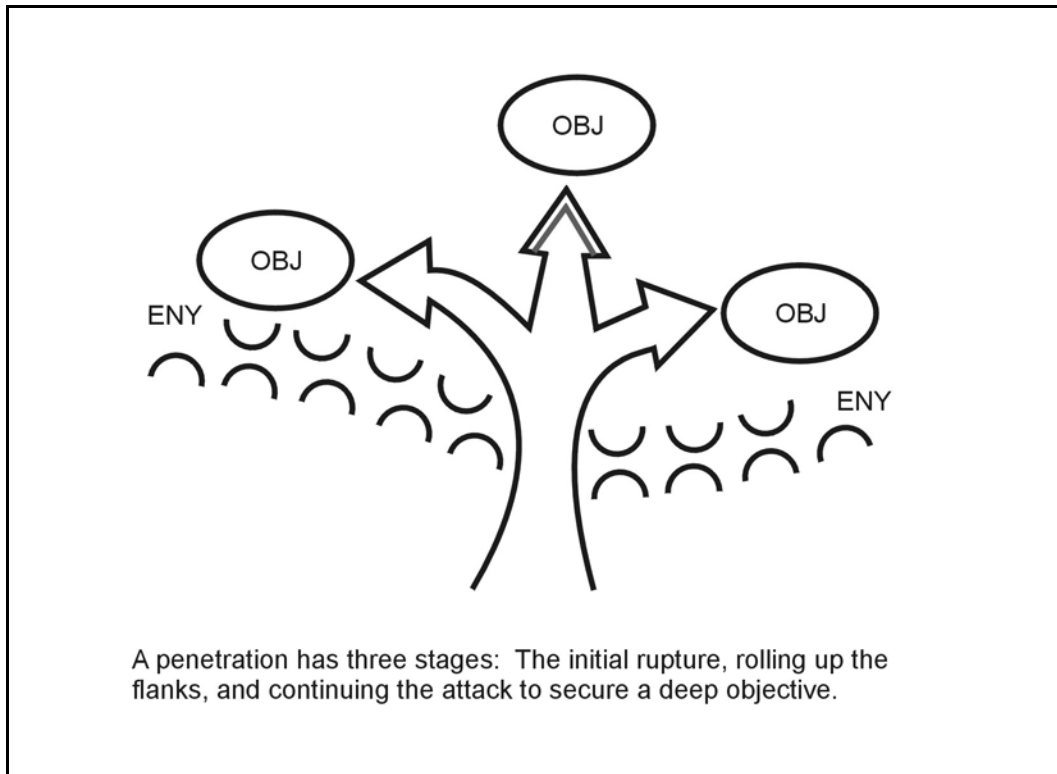

Figure 4-1. Penetration.

b. **Envelopment.** Envelopment avoids the enemy's front, where his forces are more protected and his fires more easily concentrated. Instead, while fixing the defender's attention forward by supporting attacks, the attacker maneuvers his main effort to strike at the enemy's flanks and rear. Flank attacks are a variant of envelopment in which access to the enemy's flank and rear results from the enemy's movement (Figure 4-2). Successful envelopment requires discovery or creation of an assailable flank. In meeting engagements and counterattacks, this may be the actual flank of the enemy force. In less fluid conditions, it may be a gap or weak point in the enemy's defense.

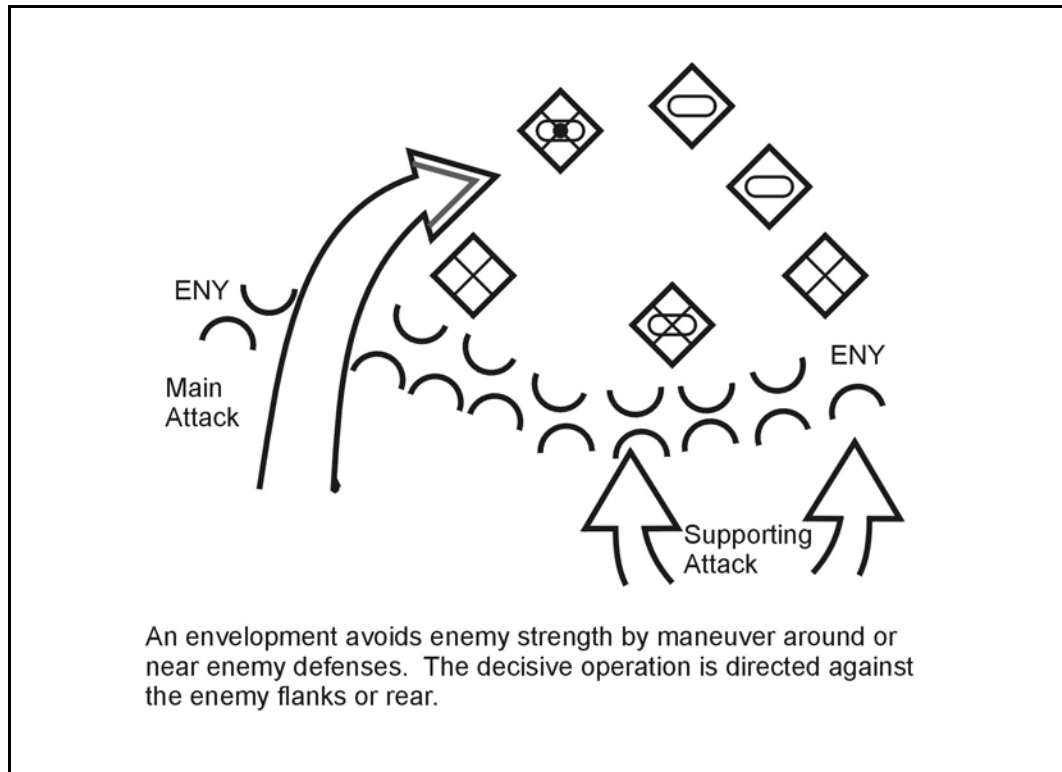

Figure 4-2. Envelopment.

c. **Turning Movement.** The turning movement is a type of envelopment in which the attacker attempts to avoid the defense entirely. Instead, he seeks to secure key terrain deep in the enemy's rear and along his lines of communication. Faced with a major threat to his rear, the enemy is thus "turned" out of his defensive positions and forced to attack rearward. For a turning movement to be successful, the unit trying to turn the enemy must attack something that the enemy will fight to save. For some, it is their supply routes; for others, it may be artillery emplacements or a headquarters. In addition to attacking a decisive target, the turning unit must be strong enough to pose a real threat to the enemy (Figure 4-3, page 4-8).

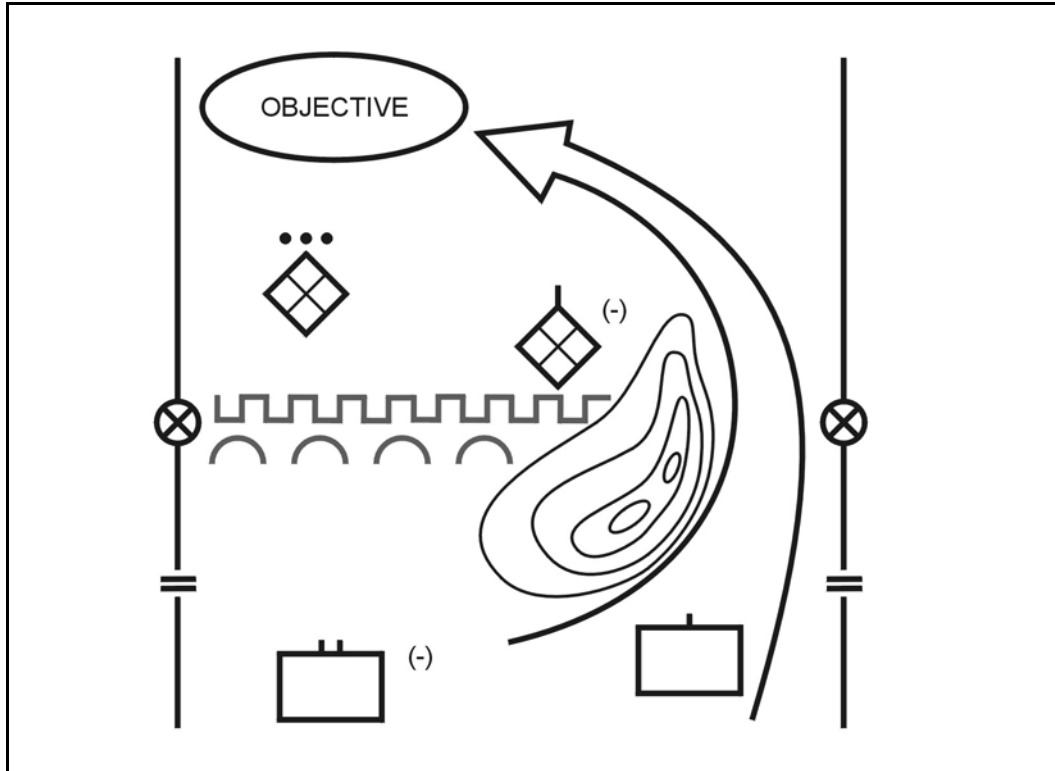

Figure 4-3. Turning movement.

d. **Frontal Attack.** A frontal attack strikes the enemy across a wide front and over the most direct approaches. For deliberate attacks, it is the least desirable form of maneuver since it exposes the attacker to the concentrated fire of the defender while at the same time limiting the effectiveness of the attacker's own fires. As the simplest form of maneuver, however, the frontal attack is useful for overwhelming weak defenses, security outposts, or disorganized enemy forces. It is often the best form of maneuver for an attack or meeting engagement in which speed and simplicity are key.

e. **Infiltration.** Infiltration is a means of reaching the enemy's rear without fighting through prepared defenses (Figure 4-4). It is the covert movement of all or part of the attacking force through enemy lines to a favorable position in their rear. The infiltrating unit avoids detection and engagement.

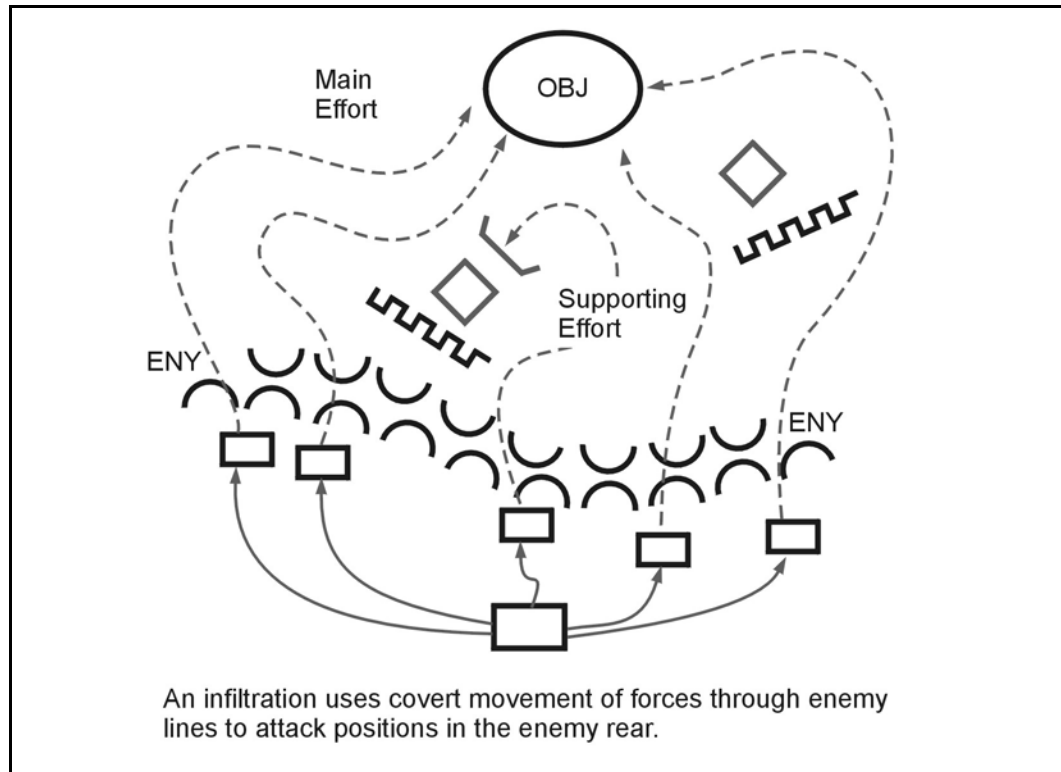

Figure 4-4. Infiltration.

Section II. MANEUVER

Maneuver is the foundation for the employment of forces on the battlefield. At the antiarmor company (or platoon) level, maneuver is the essence of every tactical operation and task. The company commander maneuvers his platoons (platoon leader maneuvers his sections) to close with the enemy, to gain positional advantage over him, and ultimately to destroy his will. Typically, the antiarmor unit will be the base of fire force for a bounding infantry force; however, this should not replace a detailed analysis of the factors of METT-TC to determine what unit will be the base-of-fire force and what unit will be the bounding force.

4-6. BASE-OF-FIRE FORCE

The combination of fire and movement first requires a base of fire, in which the antiarmor unit remains stationary and provides protection for the bounding forces by destroying, suppressing, or fixing enemy forces. The decision on weapon selection is based on a detailed METT-TC analysis. (See Appendix A, Weapon Reference Data.)

a. As the base-of-fire force, the antiarmor company (or platoon) occupies positions that afford effective cover and concealment, unobstructed observation, and clear fields of fire. Once it is in position, the base-of-fire force has the responsibility both for placing the effects of direct fires on known enemy forces and for aggressively scanning assigned sectors of observation; it identifies previously unknown enemy elements and then fires upon them. The protection provided by the base of fire force allows the bounding unit to continue its movement and to retain the initiative even when it is under enemy observation or within range of enemy weapons.

b. Maneuver is decentralized in nature; therefore, decisions on where and when to

establish a base of fire must be made at the appropriate level. These decisions normally fall to a leader on a specific part of the battlefield who knows what enemy forces can engage the bounding force and what friendly forces are available to serve as the base of fire. At the antiarmor company level (airborne and air assault battalions and SBCT), these decisions may be made by the company commander with the base of fire provided by one or more platoons. At the antiarmor platoon level (light infantry battalions), these decisions may be made by the battalion commander with the base of fire provided by the four antiarmor squads.

4-7. BOUNDING FORCE

Movement in a maneuver situation is inherently dangerous. It is complicated not only by the obvious potential for harm posed by enemy weapons but also by the uncertainty caused by unknown terrain and other operational factors.

a. The bounding force must take full advantage of whatever cover and concealment are provided by the terrain. If bounding, antiarmor leaders and drivers can enhance security by enforcing or applying the principles of terrain driving such as use of intervening terrain and avoidance of “skylining.”

b. All antiarmor squads involved in the maneuver must maintain 360-degree security at all times. Soldiers in the bounding force must continuously scan their assigned sectors of observation.

c. Although the factors of METT-TC ultimately dictate the length of the bounds, the bounding force should never move beyond the range at which the base-of-fire force can effectively suppress known, likely, or suspected enemy positions. This minimizes the bounding force’s exposure to enemy fires.

d. In severely restricted terrain, bounds are generally much shorter than in more open areas.

e. The bounding force may need infantry squads or individual crewmen to observe intervening gaps or dead space. Although this usually causes the unit to make a tactical pause, it does not slow the operation as much as the loss of a vehicle and an antiarmor squad to a hidden enemy weapon system.

f. The bounding element must remain focused on its ultimate goal of gaining a positional advantage, which it then can use to destroy the enemy by direct and indirect fires.

Section III. ACTIONS ON CONTACT

In both offensive and defensive operations, contact occurs when a member of an antiarmor company (or platoon) encounters any situation that requires an active or passive response to the enemy or to nonhostile elements, such as civilians. These situations may entail one or more of the following forms of contact:

- Visual contact (friendly elements may or may not be observed by the enemy).
- Physical contact with an enemy force or civilians.
- Indirect fire contact.
- Contact with obstacles of enemy or unknown origin.
- Contact with enemy or unknown aircraft.
- Situations involving NBC conditions.
- Situations involving electronic warfare tactics.

Leaders at all echelons conduct actions on contact when they or a subordinate element recognize one of the forms of contact or receive a report of enemy contact. The unit may conduct actions on contact in response to a variety of circumstances, including--

- Subordinate unit(s) conducting actions on contact.
- Reports from the higher headquarters.
- Reports from or actions of an adjacent unit.

4-8. DEVELOPING ACTIONS ON CONTACT

Company commanders (or platoon leaders) analyze the enemy throughout the troop-leading procedures to identify all likely contact situations that may occur during a mission. Through the planning and rehearsals conducted during troop-leading procedures, leaders develop and refine COAs to deal with probable enemy actions. The COAs eventually become the foundation for the unit's scheme of maneuver. During the troop-leading process, the leader must evaluate a number of factors to determine impacts on the unit's actions on contact.

EXAMPLE: The company commander needs to consider how the likelihood of contact affects his choice of movement techniques and formations during the attack. In doing this, he can begin preparing the unit for actions on contact. He may outline procedures for the transition to more secure movement techniques before a contact situation.

4-9. TIME REQUIREMENTS FOR ACTIONS ON CONTACT

Company commanders (or platoon leaders) must understand that properly executed actions on contact require time at section, platoon, and company levels. To develop the situation fully, a subordinate unit may need to execute extensive lateral movement, conduct reconnaissance-by-fire, and call for and adjust indirect fires. Each of these activities requires time. The commander (or platoon leader) must balance the time required for subordinate elements to conduct actions on contact with the need of his organization or the higher headquarters to maintain tempo and momentum. In terms of slowing the tempo of an operation, however, the loss of a platoon or team is normally much more costly than the additional time required to allow the subordinate element to properly develop the situation.

4-10. THE FOUR STEPS OF ACTIONS ON CONTACT

The antiarmor company (or platoon) should execute actions on contact using a logical, well-organized process of decision-making and action entailing these four steps:

- Deploy and report.
- Evaluate and develop the situation.
- Choose a COA.
- Execute the selected COA.

The four-step process is not intended to generate a rigid, lockstep response to the enemy. Rather, the goal is to provide an orderly framework that enables the unit and its subordinate elements to survive the initial contact and then to apply sound decision-making and timely actions to complete the operation. Ideally, the unit will acquire the enemy before being

sighted by the enemy. It then can initiate physical contact on its own terms by executing the designated COA.

a. **Step 1, Deploy and Report.** Events that occur during the first step of actions on contact depend in great measure on whether the contact is expected or unexpected. Whether contact is expected or unexpected. In either event, the first step of actions on contact concludes with the unit deployed (into base-of-fire and bounding forces), the enemy suppressed or destroyed, and the commander (or platoon leader) sending a contact report to the higher headquarters. The following discussion examines some of the variables a company commander faces in expected and unexpected contact situations and discusses the roles of platoon battle drills, SOPs, and reports.

(1) **Expected Contact.** If the company commander expects contact, he will already have deployed the company by transitioning to the bounding overwatch movement technique. If the company is alert to the likely presence of the enemy, it has a better chance of establishing visual contact, and then physical contact, on its own terms before being detected by the enemy. Contact, either visual or physical, usually is made by an overwatching or bounding platoon, which initiates the company's actions on contact. In a worst-case scenario, the platoon may be engaged by a previously undetected (but expected) enemy element. If so, the platoon in contact conducts a battle drill for its own survival and then initiates actions on contact.

(2) **Unexpected Contact.** In some cases, the antiarmor company will make unexpected contact with the enemy while using traveling or traveling overwatch. The element in contact, or if necessary the entire company, may have to deploy using battle drills to survive the initial contact.

(3) **Battle Drills.** Battle drills provide virtually automatic responses to contact situations in which immediate and, in many cases, violent execution of an action is critical both to the unit's initial survival and to its ultimate success in combat. Drills are not a substitute for carefully planned COAs; rather, they buy time for the unit in contact and provide a framework for development of the situation. When contact occurs, the antiarmor company's platoons deploy immediately, executing the appropriate battle drills under the direction of the commander. (For additional information on antiarmor platoon battle drills, refer to ARTEP 7-91-DRILL.)

(4) **Maneuver SOP.** An effectively written, well-rehearsed maneuver SOP helps to ensure quick, predictable actions by all members of the company. The SOP, unlike platoon battle drills, allows leaders to take into account the friendly task organization, a specific enemy, and a specific type of terrain. Therefore, the SOP can assist the company in conducting actions on contact and maintaining the initiative in a number of battlefield situations.

(5) **Reports.** Timely, accurate, and complete reports are essential throughout actions on contact. As part of the first step of the process, the company commander must send a contact report to his higher headquarters (airborne and air assault battalion or SBCT) as soon as possible after contact occurs. He provides subsequent reports to update the situation as necessary.

b. **Step 2, Evaluate and Develop the Situation.** While the antiarmor company is deploying, the commander must evaluate the situation and, as necessary, continue to maneuver to develop it.

(1) He quickly gathers as much information as possible, either visually or, more often, through reports from the platoon(s) in contact. He analyzes the information to determine critical operational considerations, including--

- Size, location, composition, activity, orientation, and capabilities of the enemy force.
- Effects of obstacles and terrain.
- Probable enemy intentions.
- How to gain positional advantage over the enemy.
- Friendly situation (location, strength, and capabilities).
- Possible friendly COAs to achieve the specified end state.

(2) After evaluating the situation, the commander may discover that he does not have enough information to identify the necessary operational considerations. To make this determination, he must further develop the situation in accordance with the higher commander's intent, using a combination of these techniques:

- Dismounted antiarmor squad members conducting surveillance (using binoculars and other optical aids).
- Mounted maneuver to gain additional information by viewing the enemy from another perspective.
- Indirect fire.
- Reconnaissance by fire.

(3) Once the commander determines the size of the enemy force the company has encountered, he sends a report to his higher headquarters.

c. **Step 3, Choose a COA.** After developing the situation and determining that he has enough information to make a decision, the company commander selects a COA that both meets the requirements of his higher commander's intent and is within the company's capabilities.

(1) **Nature of Contact.** The nature of the contact (expected or unexpected) may have a significant impact on how long it takes a commander to develop and select a COA.

EXAMPLE: In preparing to conduct an attack, the company commander determines that the company will encounter an enemy security force along its axis of advance. During the TLP, he develops a scheme of maneuver to defeat the security force. When the company's lead platoon makes contact with the enemy, the commander quickly assesses that this is the anticipated contact and directs the company to execute his plan. On the other hand, unexpected contact with a well-concealed enemy force may require time for development of the situation at the platoon and section levels. The company commander employs several techniques for developing the situation as his subordinate elements fight for critical information that will eventually allow him to make a sound decision.

(2) **COA Procedures.** The company commander has several options for selecting a COA.

(a) If his development of the situation reveals no need for change, he directs the company

to execute the original plan.

(b) If his analysis shows that the original plan is still valid but that some refinement is necessary, he informs his higher commander (prior to execution, if possible) and issues a FRAGO to refine the plan.

(c) If his analysis shows that the original plan needs to be changed but that the selected COA will still comply with his higher commander's intent, the company commander informs the higher commander (prior to execution, if possible) and issues a FRAGO to re-task his subordinate elements.

(d) If his analysis shows that the original plan deviates from the higher commander's intent and needs to be changed, the company commander must report the situation and, based on known information in response to an unforeseen enemy or battlefield situation, recommend an alternative COA to his higher commander.

(e) If the battlefield picture is still vague, the company commander must direct the company or a platoon to continue to develop the situation. This will allow him to gather the information needed to clarify a vague battlefield picture. He then uses one of the first four options to report the situation, choose a COA, and direct further action.

d. **Step 4, Execute the Selected COA.** In executing a COA, the antiarmor company transitions to maneuver. It then continues to maneuver throughout execution, either as part of a tactical task or as an advance while in contact to reach the point on the battlefield from which it executes its tactical task. The company can employ a number of tactical tasks as COAs, any of which may be preceded and followed by additional maneuver. As execution continues, more information will become available to the company commander. Based on the emerging details of the enemy situation, he may have to alter his COA during execution.

Section IV. TYPES OF OFFENSIVE OPERATIONS

This section focuses on offensive operations that the antiarmor company (or platoon) normally conducts as part of a larger element: attack, movement to contact, exploitation, and pursuit. The section examines the various roles the antiarmor company (or platoon) may hold in these operations and the tactics for conducting--

- Force-oriented attacks against a stationary enemy force.
- Force-oriented attacks against a moving enemy force.
- Terrain-oriented attacks.

4-11. ATTACK CHARACTERISTICS

An attack is a type of offensive operation characterized by movement supported by fire. The purpose of an attack is to defeat an enemy force or to seize terrain. The antiarmor company (or platoon) can attack independently or as part of a larger element. The two basic types of attack are the hasty attack and the deliberate attack (see paragraph 4-12). Figure 4-5, page 4-16, illustrates the situations under which a unit conducts an attack, compares them to the amount of planning and preparation time, and provides options for the commander (or platoon leader) to accomplish his purpose and support the higher commander's intent. (For more information on the attack options, see paragraph 4-13). All attacks, both hasty and deliberate, depend on synchronization for success. They require planning, coordination, and time to prepare.

- a. The company commander (or platoon leader) translates the mission assigned by the

higher headquarters, through analyzing the task and purpose, into specific missions for subordinate units. To facilitate parallel planning, he immediately forwards these, along with the appropriate portions of the higher headquarters' plan and order, to subordinate units. Commanders and platoon leaders must work together to develop the best plan. This requires sharing information freely between the command posts. The goal is not simply to reduce the time required to produce and distribute the plans, but, more importantly, to produce a better plan by including input from adjacent, higher, and lower elements. Additionally, this collaboration promotes understanding of the plan, thereby enhancing preparation and execution.

b. As the antiarmor company (or platoon) plans, the enemy also has time to improve his defenses, disengage, or conduct spoiling attacks of his own. Clearly, planning must be accomplished in the shortest time possible and must accommodate the changes driven by what the enemy does.

NOTE: The information systems available to the SBCT antiarmor company facilitate detailed planning. By properly leveraging digital INFOSYS and sensors, the SBCT antiarmor company commander can obtain near-real-time knowledge of enemy composition, locations, activity, and probable intentions. Thus, modern technology improves the company commander's ability to develop his COA and plan his actions against an enemy force from either stationary or moving C2 platforms.

		Attack Situations		
		Force-Oriented Moving Enemy	Force-Oriented Stationary Enemy	Terrain-Oriented
Planning Time		Attack Options		
	Less Time Available	<ul style="list-style-type: none"> • Hasty attack to [destroy, disrupt, or block] • Counterattack • Spoiling attack • Ambush 	<ul style="list-style-type: none"> • Hasty attack to [destroy, disrupt, block] • Counterattack • Feint • Demonstration 	<ul style="list-style-type: none"> • Hasty attack to [seize, clear, or secure] • Counterattack
	More Time Available	<ul style="list-style-type: none"> • Deliberate attack to [destroy, disrupt, or block] • Counterattack • Spoiling attack • Ambush • Feint • Demonstration 	<ul style="list-style-type: none"> • Deliberate attack to destroy • Raid • Counterattack • Feint • Demonstration 	<ul style="list-style-type: none"> • Deliberate attack to [seize, clear, or secure] • Counterattack

Figure 4-5. Continuum of attacks.

4-12. HASTY AND DELIBERATE ATTACKS

In addition to having different forms based on their purposes, attacks are characterized as hasty or deliberate. The primary difference between them is the extent of planning and preparation conducted by the attacking force, but no clear distinction exists between deliberate and hasty attacks. Attacks range along a continuum. At one end of this continuum the company commander (or platoon leader) issues a FRAGO that directs a hasty attack with rapid execution of battle drills by forces immediately available. These attacks rely on an implicit understanding and FM radio (or digital) communication with detailed orders and appropriate branches or sequels that make understanding explicit. Information on the general enemy situation may come from a movement to contact, and the unit launches a hasty attack as a continuation of the meeting engagement. The hasty attack capitalizes on a temporary advantage in relative combat power and may preempt enemy actions. At the other end of the continuum, the unit moves into a deliberate attack from a reserve position or assembly area with detailed knowledge of the enemy, a task organization designed specifically for the attack, and a fully rehearsed plan. Most attacks fall somewhere between these two ends of the continuum.

a. **Hasty Attack.** The antiarmor company commander (or platoon leader) may conduct a hasty attack during a movement to contact, as part of a defense, or whenever he determines that the enemy is in a vulnerable position and can be quickly defeated by immediate offensive action. A hasty attack is used to--

- Exploit a tactical opportunity.
- Maintain the momentum.
- Regain the initiative.
- Prevent the enemy from regaining organization or balance.
- Gain a favorable position that may be lost with time.

Because its primary purpose is to maintain momentum or take advantage of the enemy situation, the hasty attack is normally conducted with only the resources that are immediately available. Maintaining unrelenting pressure through hasty attacks keeps the enemy off balance and makes it difficult for him to react effectively. Rapidly attacking before the enemy can act often results in success even when the combat power ratio is not as favorable as desired. With its emphasis on agility and surprise, however, this type of attack may cause the attacking force to lose a degree of synchronization. To minimize this risk, the commander (or platoon leader) should maximize use of standard formations and well-rehearsed and thoroughly understood battle drills and SOPs. By maintaining situational understanding and assigning on-order and be-prepared missions to subordinate units as the situation warrants, the antiarmor company (or platoon) is better able to transition into hasty attacks. The hasty attack is often the preferred option during continuous operations. It allows the commander (or platoon leader) to maintain the momentum of friendly operations while denying the enemy the time needed to prepare his defenses and to recover from losses suffered during previous action. Hasty attacks normally result from a movement to contact, successful defense, or continuation of a previous attack.

(1) **Task Organization.** The hasty attack is conducted using the principles of fire and movement. The controlling headquarters normally designates a base-of-fire force and a bounding force. This may be within the antiarmor company (or platoon) or as part of a larger force. As part of a larger force, the company (or platoon) typically will be designated as the base-of-fire force, while an infantry unit will be designated as the bounding force.

(2) **Conduct of the Hasty Attack.** The unit must first conduct actions on contact, allowing the commander (or platoon leader) to gather the information he needs to make an informed decision. The term "hasty" refers to trading available planning and preparation time for speed of execution. The commander (or platoon leader) bases his decisions on his current knowledge of the enemy situation, his own forces, and the terrain. He makes this choice in an environment of uncertainty, which may entail some risk.

(a) Execution begins with establishment of a base of fire, which then suppresses the enemy force. The bounding force uses a combination of techniques to maintain its security as it advances in contact to a position of advantage. These techniques include, but are not limited to, the following:

- Use of internal base-of-fire and bounding elements.
- Use of covered and concealed routes.
- Use of indirect fires to suppress or obscure the enemy or to screen friendly movement.
- Execution of bold maneuver that initially takes the bounding force out of enemy direct fire range.

(b) Once the bounding force has gained the positional advantage, it can execute a tactical task, such as assault, to destroy the remaining enemy.

b. **Deliberate Attack.** The antiarmor company (or platoon) typically will conduct a

deliberate attack as part of a larger force. It conducts a deliberate attack by itself only when the enemy's strength prevents it from conducting a hasty attack. A deliberate attack normally is conducted against a strong enemy defense. As the company (or platoon) prepares for the attack, the enemy will continue to strengthen his position. Deliberate attacks follow a distinct period of preparation, which is used for extensive intelligence, surveillance, and reconnaissance (ISR) operations, detailed planning, task organization of forces, preparation of troops and equipment, coordination, rehearsals, and plan refinement. The deliberate attack is a fully synchronized operation that employs every available asset against the defending enemy. It is characterized by a high volume of planned fires (direct and indirect), use of major supporting attacks, forward positioning of resources needed to maintain momentum, and operations throughout the depth of enemy positions. Thorough preparation allows the attacking force to stage a combined-arms and fully integrated attack. Likewise, however, the enemy will have more time to prepare his defensive positions and integrate fires and obstacles. The factors of METT-TC dictate how thoroughly these activities are accomplished. A unit normally conducts a deliberate attack when enemy positions are too strong to be overcome by a hasty attack. In weighing his decision to take the time required to prepare for and conduct the deliberate attack, the commander (or platoon leader) must consider the advantages that may be gained by both friendly and enemy forces.

(1) **Task Organization.** Typically, antiarmor companies and platoons will be task-organized by the higher headquarters as the support force for the conduct of a deliberate attack. However, the higher headquarters may give other assets (such as infantry or engineers) to an antiarmor company to perform the duties of the assault or breach forces.

(2) **Conduct of the Deliberate Attack.** A deliberate attack is normally broken into the following steps:

(a) **Attack in Zone.** The attacking unit advances to within assault distance of the enemy position under supporting fires and using any combination of movement techniques. Subordinate units advance to successive positions using available cover and concealment. The company commander (or platoon leader) may designate support-by-fire positions to protect friendly forces with suppressive direct fires. As the unit maneuvers in zone, it employs indirect fires to suppress or obscure enemy positions.

(b) **Actions at the Probable Line of Deployment.** The PLD is normally a phase line or checkpoint where elements of the attacking unit transition to secure movement techniques in preparation for contact with the enemy. Subordinate units may maneuver from the PLD to designated support-by-fire positions or to breach or bypass sites. The PLD may be collocated with the assault position.

(c) **Actions on the Objective.** The final assault combines the effects of overwhelming combat power and suppressive fires with the use of maneuver to gain positional advantage over the defending enemy. Fires from support forces and from supporting indirect fire assets isolate the objective area and suppress the enemy. These fires protect the assault force as it closes with the enemy. Other measures the unit may use to set the conditions for the final assault include, but are not limited to, the following:

- Employment of mortar, artillery, or direct fires (or a combination of these) from support-by-fire positions, to destroy enemy forces on the objective or to isolate enemy forces on the objective and create favorable force ratios.
- Use of obscuring smoke.

Once the conditions are set, the assault forces maneuver to close with and destroy the enemy. Other elements continue to provide support as necessary throughout the assault.

4-13. ATTACK OPTIONS

The forms of attack an antiarmor company (or platoon) is most likely to conduct are raid, ambush, spoiling attack, counterattack, feint, and demonstration. The following paragraphs describe the company's role in accomplishing these forms of attack. The commander (or platoon leader) selects weapons based on a detailed analysis of the factors of METT-TC. (See Appendix A, Weapon Reference Data.)

a. **Raid.** This is a limited-objective form of attack entailing swift penetration of hostile terrain. A raid operation always ends with a planned withdrawal to a friendly location upon the completion of the assigned mission. A raid is not intended to hold territory. The antiarmor company (or platoon) can conduct an independent raid or it can participate in a higher unit offensive operation that encompasses several related raids or other related operations.

(1) **Role.** The antiarmor company (or platoon) conducts raids to accomplish a number of missions, including the following:

- Destroy specific command and control locations.
- Destroy logistical areas.
- Destroy vehicle laager areas.
- Confuse the enemy or disrupt his plans.
- Obtain information concerning enemy locations, dispositions, strength, intentions, or methods of operation.

(2) **Task Organization.** Task organization of a raiding force is based on the factors of METT-TC and the purpose of the operation. It normally consists of the following elements:

- Support force.
- Assault force.
- Breach force (if required).

(3) **Conduct of the Raid.** The main differences between a raid and other attack forms are the limited objectives of the raid and the associated withdrawal following completion. Raids may be conducted in daylight or darkness, within or beyond supporting distance of the parent unit. When the area to be raided is beyond supporting distance of friendly lines, the raiding party operates as a separate force. An objective, usually very specific in nature, normally is assigned to orient the raiding unit. During the withdrawal, the attacking force normally takes a route or axis different from that used to conduct the raid itself.

b. **Ambush.** An ambush is a surprise attack, from concealed positions, on a moving or temporarily halted enemy. It may take the form of an assault to close with and destroy the enemy, or it may be an attack by fire only, executed from concealed positions. An ambush does not require that ground be seized or held. Although the execution of an ambush is offensive in nature, the unit may be directed to conduct an ambush in a wide variety of situations. It may stage the ambush during offensive or defensive operations, as part of the higher unit's sustaining operations, or during retrograde operations. The commander (or platoon leader) in his METT-TC analysis must consider the capabilities of his unit in the mounted and dismounted role. Operational security (OPSEC) is critical to the success of an ambush. The unit must take all necessary precautions to ensure that it is not detected during

movement to or preparation of the ambush site. The unit must also have a secure route of withdrawal following the ambush.

(1) **Role.** The antiarmor company (or platoon) generally conducts an ambush to reduce the enemy force's overall combat effectiveness. Destruction is the primary reason for conducting an ambush. Other reasons for an antiarmor company (or platoon) to conduct ambushes are--

- To confuse the enemy or disrupt his plans.
- To harass the enemy.
- To capture the enemy.

(2) **Task Organization.** The unit is normally task-organized into assault, support, and security forces for the execution of the ambush.

(a) The assault force executes the ambush. It may employ an attack by fire, an assault, or a combination of those techniques to destroy the ambushed force.

(b) The support force fixes the enemy force and prevents it from moving out of the kill zone, allowing the assault force to conduct the ambush. The support force generally uses direct fires in this role; however, it may also be responsible for calling for and adjusting indirect fires to assist in fixing the ambushed force.

(c) The security force provides protection and early warning to the ambush patrol and secures the objective rally point (ORP) or assault position. It isolates the ambush area both to prevent the ambushed enemy force from moving out of the ambush site and to keep enemy rescue elements from reaching the site. The security force may also be responsible for securing the unit's withdrawal route.

(3) **Conduct of the Ambush.** An ambush normally consists of the following actions:

- Tactical movement to the ORP or assault position.
- Reconnaissance of the ambush site.
- Establishment of ambush site security.
- Preparation of the ambush site.
- Execution of the ambush.
- Withdrawal.

(4) **Types of Ambushes.** Once the unit receives an order to conduct an ambush, the commander (or platoon leader) must determine which of the two types of ambush operations is best suited to the situation and the capabilities of his company. In a *point ambush*, the unit deploys to attack an enemy force in a single kill zone. In an *area ambush*, the unit is deployed to conduct several related point ambushes throughout an ambush area.

c. **Spoiling Attack.** This is a limited-objective attack to delay, disrupt, or destroy the enemy's capability to attack. Units mount spoiling attacks from defensive postures to disrupt expected enemy attacks. A spoiling attack attempts to strike the enemy while he is most vulnerable--during his preparations for attack in assembly areas and attack positions or while he is on the move prior to crossing his line of departure. In most respects, units conduct spoiling attacks like any other attack. They may be hasty (when planning time is short) or deliberate (when the unit has obtained adequate forewarning). When the situation permits, commanders (or platoon leaders) exploit a spoiling attack like any other attack.

d. **Counterattack.** This is an attack by defensive forces to regain the initiative or to deny the enemy success with his attack. Commanders conduct counterattacks either with a reserve or with lightly committed forward elements. They counterattack after the enemy

launches his attack, reveals his main effort, or creates an assailable flank. The antiarmor company commander (or platoon leader) conducts a counterattack much like other attacks, but synchronizing them within the overall defensive effort requires careful timing.

(1) Counterattacks afford the defender the opportunity to create favorable conditions for the commitment of combat power. If it is possible to fix the enemy, then counterattacks can be rehearsed, their timing can be controlled, and the ground to be traveled can be prepared. Counterattacks are most useful when they are anticipated, planned, and executed in coordination with other defending, delaying, or attacking forces and in conjunction with a higher commander's plan.

(2) As in spoiling attacks, company commanders (or platoon leaders) prepare to seize the opportunity to exploit success by the entire force. However, counterattacks may be limited to movement to better terrain in order to bring fires (TOW, M2, or MK19) on the enemy. Given the same forces on both sides, counterattacks can achieve greater effects than other attacks because the defender can create more favorable conditions through rehearsal and control of the timing.

e. **Feint.** The feint is in many ways identical to other forms of the attack. Its purpose is to cause the enemy to react in a particular way, such as by repositioning forces, committing its reserve, or shifting fires. The key difference between the feint and other attack forms is that it is much more limited in scope, with an extremely specific objective. The scale of the operation, however, usually is apparent only to the controlling headquarters. For the element actually conducting the feint, such as an antiarmor company, platoon, or section, execution is just as rapid and as violent as in a full-scale attack.

(1) **Role.** The unit normally participates in a feint as part of a larger element. Among the planning considerations that the antiarmor company commander (or platoon leader) must keep in mind are the following:

- The higher commander's intent regarding force preservation.
- Disengagement criteria and plans.
- Assignment of limited depth and attainable objectives.
- Clear and concise "follow-on" orders ensure the unit conducting the feint is prepared to exploit the success of the decisive operation, if necessary.

(2) **Making Feints Believable.** Feints are successful only if the enemy believes that a full-scale attack operation is underway. To be believable, the unit must be task-organized to appear as a credible threat, and the unit must conduct the feint with the same violence and the same level of precision as any other attack. The controlling headquarters must issue a clear task and purpose to the unit conducting the feint. This should include identification of the specific enemy action the feint is supposed to trigger or deny (purpose), such as forcing the commitment of an enemy reserve force or preventing an enemy element from repositioning against the main effort attack. Feints are most effective under the following conditions:

- When they reinforce the enemy's expectations.
- When the attack appears to present a credible threat to the enemy.
- When the enemy retains a large reserve and consistently commits it early in a battle.
- When the attacker has several feasible COAs, any of which the enemy could mistake for the main effort.

f. **Demonstration.** The demonstration is an attack whose purpose is to deceive the enemy about the location of the decisive operation. The purpose of a demonstration is similar to that of a feint, but the friendly force does not make contact with the enemy.

EXAMPLE: A light infantry battalion antiarmor platoon's role might entail establishing an attack-by-fire (ABF) position beyond the enemy's direct fire engagement range. This will cause the enemy commander to commit his tank platoon reserve away from the light infantry battalion's decisive operation simply by virtue of the positioning of the antiarmor platoon.

In preparing to participate in a demonstration as part of a larger force, the antiarmor company commander (or platoon leader) should keep in mind these planning considerations:

(1) The limit of advance must be carefully planned so the enemy can observe the demonstration force but cannot effectively engage it with direct fires. The force must also take any other security measures necessary to prevent engagement by the enemy.

(2) The demonstration force must develop plans so it can respond effectively to enemy direct or indirect fires, avoiding decisive engagement.

(3) Clear and concise "follow-on" orders must be issued to ensure that the demonstration force is prepared to exploit the success of the decisive operation, if necessary.

4-14. MOVEMENT TO CONTACT

Movement to contact is designed to gain or regain contact with the enemy. It is normally used when the enemy situation is vague and there is not time to reconnoiter extensively to locate the enemy. Movement to contact ends when contact is made. (Contact results in initiation of another operation such as attack against a stationary or moving enemy force, defense, delay, or withdrawal.) The antiarmor company (or platoon) normally conducts movements to contact as part of a larger force. Based on the factors of METT-TC, however, an antiarmor company might conduct the operation independently.

EXAMPLE: An airborne infantry battalion antiarmor company may conduct movement to contact prior to occupation of a screen line. Because the enemy situation is not clear, the company moves in a way that provides security and supports a rapid buildup of combat power against enemy units once they are identified.

Two techniques for conducting a movement to contact are the approach-march technique and the search-and-attack technique. If no contact occurs, the company may be directed to conduct consolidation on the objective. The following paragraphs examine the role of the antiarmor company (or platoon) in a higher unit's movement to contact.

a. **Fundamentals.** The antiarmor company commander (or platoon leader) analyzes the situation and selects the proper techniques to conduct the mission. He reports all information

rapidly and accurately and strives to gain and maintain contact with the enemy. He retains freedom of maneuver by moving the unit in a manner that--

- Makes enemy contact with the smallest element possible.
- Rapidly develops combat power upon enemy contact.
- Provides all-round security for the unit.
- Supports the higher commander's concept and intent.

b. **Considerations.** The higher unit may direct the antiarmor company's technique. If not, the antiarmor company commander considers his mission and the higher unit concept as he conducts his estimate to select the best technique. Normally, when operating as part of a higher unit's movement to contact, the company employs the same technique as that unit. The company commander must consider the mounted capabilities of his company during both techniques. The following considerations also may assist the commander in developing his concept.

(1) **Time Available.** The time available for planning, coordinating, and rehearsing may affect the decision. The approach-march technique generally requires much less time for preparation. The company may require only a brief FRAGO assigning the movement formation or technique and some simple graphic control measures to begin movement. The search-and-attack technique may require more preparation time because the subordinate units have more planning responsibilities (such as patrol base, linkups, and casualty evacuations [CASEVACs]).

(2) **Speed of Movement.** The speed at which the antiarmor company is required to move is a major factor. With either technique, the faster the company moves, the less effective are the reconnaissance efforts. Thus, it becomes more likely that the enemy will initiate fires at the time and place he selects. The approach-march technique normally is more effective for quickly reacting to enemy contacts.

(3) **Enemy.** The company commander considers the clarity of the enemy situation. Although the enemy situation is vague in every movement to contact, the company commander should have some information. Knowing where the enemy will probably locate and in what strength is key. The company commander considers the enemy's probable locations to plan the company's movement and their probable strength to determine his security needs and analyze the risks for each technique. The company commander also considers the expected enemy action upon contact. If he expects the enemy to fight, then the approach march may be the more effective technique. If the enemy will attempt to avoid detection or quickly disengage, the search-and-attack technique may be the better method.

(4) **Security.** The amount of preparation time, the required movement speed, and the enemy situation all directly impact on the company's security requirements. The company commander also considers the terrain, the adjacent units, the available combat support, and the present status of his unit to determine how to provide security for his company. Successful movements to contact depend on locating the enemy without being detected. This provides the company commander the initiative to develop the situation by fully coordinating and supporting the attack with all available resources.

c. **The Approach-March Technique.** An approach march (a method of troop movement) is the advance of a combat unit when direct contact with the enemy is intended. The antiarmor company (or platoon) normally uses this technique when it is conducting a movement to contact as part of the larger force. The company (or platoon) can be tasked to

act as the advance guard, to move as part of the higher unit main body, or to provide flank or rear guards for the higher unit, depending on its location in the formation and its assigned mission. The antiarmor company (airborne or air assault battalion or SBCT) is capable of conducting a movement to contact by itself using this technique.

(1) **Planning.** When planning for a movement to contact (approach-march), the antiarmor company commander needs certain information from the higher commander. With this information, he develops his scheme of maneuver and fire support plan. He provides this same information to the platoon leaders. As a minimum, he needs to know--

- The company's mission.
- The friendly and enemy situations.
- The route (axis of advance) and the desired rate of movement.
- The control measures to be used.
- The company's actions on contact.
- The fire support plan.
- The company's actions upon reaching the march objective, if one is used.

(2) **Lead Company Responsibilities.** The higher unit may conduct a movement to contact on a single axis or on multiple axes. If the antiarmor company is the lead company on an axis, it is responsible for--

- Protecting the higher unit from a surprise attack by providing early warning of enemy positions and obstacles.
- Assisting the forward movement of the higher unit by removing obstacles or finding routes around them.
- Destroying enemy forces (within its capability).
- Rapidly developing the situation once contact is made.

(3) **Lead Company Movement.** The lead company or advance guard on an axis moves using traveling overwatch or bounding overwatch, depending on the situation. It is normally assigned an axis of advance or a zone of action and a march objective on which to orient its movement. Phase lines and checkpoints also may be used to help control movement.

(a) The company commander selects the movement technique and formation based on the likelihood of enemy contact and the speed of movement desired by the higher commander. Bounding overwatch provides the best security, but traveling overwatch is faster. If the company uses traveling overwatch, the lead platoon may use bounding overwatch for added security.

(b) The company commander must retain the freedom to maneuver his platoons and weapons systems. He analyzes the terrain, anticipates where he might make contact, and plans fires on those locations. He should avoid terrain that restricts maneuver such as draws, ravines, narrow trails, and steep slopes.

(4) **Other Companies.** A company not in the lead uses traveling or traveling overwatch. It must be ready to fire or maneuver in support of the lead company or to assume the lead company's mission.

(5) **Contact.** Once contact is made with the enemy, the company commander maintains that contact until ordered to do otherwise by the higher commander. The following actions must take place immediately:

(a) When there is an unexpected contact as a result of inadequate information, the platoon in contact returns fire immediately and seeks cover. If the enemy is unaware, the

platoon making contact reports and deploys to prevent detection. The maneuver to a position of advantage by this platoon (or other units) should maintain the element of surprise until preparation for the hasty attack is completed. If detected, or once the decision is made to initiate the hasty attack, the platoon leader attempts to fight through, destroying the enemy with the resources that are immediately available. He should begin calling for fire. He then reports to the company commander and develops the situation. The overwatch element immediately fires at the enemy position. Trail platoons that are not able to fire take cover and wait for orders.

(b) The antiarmor squad or platoon that initially received direct fire immediately executes the react to contact battle drill (ARTEP 7-91-DRILL). The intent is to use aggressive small-unit actions to seize the initiative rapidly and at the lowest echelon possible. The unit in contact attempts to achieve fire superiority to fix or suppress the enemy with the resources that are immediately available. The unit then executes a flank attack directed against an identified enemy weakness. If this is not possible, the unit develops the situation to identify the enemy's flanks, any covered and concealed routes around the enemy position, possible supporting positions (both friendly and enemy), and any protective obstacles that the enemy has constructed. It then reports this information to the company commander.

(c) Upon receipt of this information, the company commander determines the proper action to take. The XO reports the situation to battalion. The company commander may conduct, or direct his units to conduct, additional reconnaissance. The company FSO requests and coordinates indirect fires to support the company's maneuver. Possible actions include--

- Conduct a hasty attack. If the company commander feels he can defeat the enemy force and an attack supports the higher commander's concept, he conducts a hasty attack immediately, before the enemy can react.
- Bypass the enemy. The company commander, with higher unit permission, may bypass an enemy force. He may bypass the enemy with one platoon at a time or with the entire company at once. He also may be directed to fix or suppress the enemy while the higher unit bypasses. Indirect fires also are used to suppress the enemy. When the company has suppressed the enemy, the higher commander may order the company to disengage and rejoin the formation or to hand the enemy off to a trailing unit.
- Establish a hasty defense. Although this gives the initiative to the enemy force, it might provide a needed advantage, which might be required in a meeting engagement with a superior force. The company may establish a hasty defense to protect itself while the remainder of the higher unit is maneuvering against the enemy.
- Disengage. This is not a preferred option unless disengaging is the only way to ensure preservation of the force. Use of indirect fires and bounding and overwatch elements is essential in disengaging from a superior force. The company may disengage while another unit maintains contact, or the company may disengage by moving back through the higher unit to draw the enemy into an ambush.

d. **The Search-and-Attack Technique.** This decentralized technique uses multiple, coordinated, small-unit (squad, section, or platoon) actions to find, fix, and finish the enemy. If the unit makes contact without being detected by the enemy, the unit gains the initiative

and has three options:

- Destroy the enemy with the immediately available combat potential.
- Maneuver the remainder of the unit to destroy the enemy
- Follow the enemy back to his base camp and destroy him there.

Antiarmor units will conduct the search-and-attack as part of a larger force. The antiarmor platoon in a light infantry battalion will typically isolate the search area or reinforce a rifle company. The antiarmor companies from airborne or air assault battalions or SBCTs can isolate the area or be task-organized by the higher headquarters to effectively conduct a search-and-attack in an assigned AO. During his planning, the antiarmor company commander decides how to find the enemy, how to fix or follow him, and then how to finish him.

(1) **Concept Development.** Initially, the decisive point is identified as the most likely enemy location. Once the enemy location has been confirmed, a concept can be developed for generating overwhelming combat power at that location. The initial concept must include the actions to finish the enemy force once it is located. At times, this part of the plan may be very general or consist only of control measures and be-prepared missions to provide flexibility and support the rapid issuance of fragmentary orders (FRAGOs).

(a) The company commander must understand the higher commander's concept and what freedom of action the company has to engage the enemy. At times, the company must engage and destroy all enemy forces within their capabilities. In other cases, the company is expected to locate, follow, and report small enemy units to allow other companies to concentrate and destroy these enemy forces.

(b) The company commander must focus his platoons on the likely enemy locations. He assigns missions in accordance with (IAW) the higher commander's concept. Possible operations include a zone or area reconnaissance, an ambush, and surveillance. Small unit leaders (for example, antiarmor squad leaders or attached rifle squad leaders) must know what actions to take when they locate the enemy either with or without being detected. The platoon most likely to make contact is normally designated the company's main effort.

(2) **Considerations.** The company commander usually determines the number and size of the units that will conduct reconnaissance and combat actions against the enemy. The size of the area, the duration of the mission, and the probable size of the enemy force are key to this decision.

(a) A detailed METT-TC analysis is essential to the success of a search-and-attack. The size of the AO is considered in relation to how much time is available to search the area. When allocating terrain, the company commander considers how the subordinate units will conduct the reconnaissance, how to provide security, and how to provide control. One technique is to assign a small AO that keeps the subordinate units more concentrated, helping to maintain control. On order, the subordinate units are directed to move into the next AO. Another technique is to divide the area into zones. The company commander concentrates most of the company in one zone and uses small team or rifle squad patrols to reconnoiter the next zone. Once the antiarmor company has completed the reconnaissance in the initial zone, it moves into the area that has been reconnoitered by the small units. This technique is effective when a detailed reconnaissance is required, but it also supports the seizure of the initiative through speed, stealth, and surprise. The small, dispersed units have a better chance of locating the enemy and remaining undetected. The company commander focuses the

remainder of the company's reconnaissance efforts based upon the information gathered during the initial reconnaissance.

(b) The company commander must consider how the duration of the mission affects the company. If the mission will continue for days or longer, the commander must develop a concept that allows his subordinates to maintain combat effectiveness. The concept must address operations during limited visibility. He must ensure that the concept provides sufficient rest to maintain his soldiers' stealth, alertness, and security.

(c) The duration of the mission also affects the need to resupply. This has a tremendous impact on a search-and-attack mission. The longer the mission is expected to last, the more often the need for resupply. Resupply operations hinder the ability to move with stealth and security while close to the enemy and allow the enemy to locate the unit by following or observing the resupply vehicles. The company commander must determine the essential supplies required for the operation. If this results in excessive amount of supplies, he plans for resupply operations that avoid enemy detection and maintain the security of the company. Another technique is to identify platoon ORPs or company patrol bases throughout the AO. The company moves between these locations using the approach-march technique to provide greater control and security. After securing and occupying the next ORP or patrol base, the unit receives the necessary supplies.

(d) Knowing the size of the enemy units with which the company is likely to make contact assists the company commander in determining the risk to the company. The company commander also must consider the enemy's capabilities, likely COAs, and specific weapons capabilities in order to understand the threat and ensure the security of his company, even when conducting decentralized operations. The company commander may direct specific force protection restraints such as "no patrols smaller than a rifle squad or antiarmor section," "platoons must be able to consolidate within 20 minutes," or "platoons will depart their patrol bases NLT 60 minutes prior to BMNT."

(3) **Find the Enemy.** During this step, the focus is on reconnaissance to locate the enemy. Generally, small units able to move quickly and with stealth are more likely to locate the enemy without detection. The company commander's concept may restrict the platoon's authority to destroy the enemy once located. It may be more important to locate and follow enemy units to identify their base camps. When not restricted, however, the unit making contact takes immediate action to destroy the enemy. If it is not within this unit's capabilities, the platoon conducts linkups to mass sufficient combat potential and to coordinate the attack.

(a) Platoons do not receive a mission with the vague requirement to search-and-attack. The company commander must be more specific in stating his concept. His concept also must address the likely actions to destroy the enemy once it is located. Specific taskings may include route, area, and zone reconnaissance or surveillance tasks. Platoons may also be tasked to conduct ambushes, to be prepared to conduct an attack to destroy enemy forces, to provide security for another force such as the command post (CP) or the mortars, or to perform duties as the company reserve.

(b) During limited visibility, reconnaissance is more difficult and potentially more dangerous. If a unit makes contact with the enemy in the dark, a hasty attack is very risky. Reconnaissance is also less effective in the dark because the unit covers less area and is unable to detect many signs of enemy activity. Route and small-area reconnaissance tasks are more effective for limited visibility.

(c) Ambushes are also very effective during limited visibility. The enemy may avoid daylight movements if aware of the company's presence in the AO. Ambushes should be set up on the enemy's likely routes or near their sources of supply. Patrol bases should integrate ambushes and observation posts (with thermal sights and NVDs) into their security plans.

(4) ***Fix and Finish the Enemy.*** These steps of a search and attack are closely related. An initial attempt to finish the enemy by the platoon in contact quickly may become the fixing effort for the company's attack if the enemy is too strong for the platoon or if the platoon is unable to achieve surprise. When the authority to conduct offensive actions to destroy the enemy has been decentralized to the lowest level, the fundamentals of an attack apply at every echelon.

(a) ***Achieve Surprise.*** Locate the enemy without being detected. This allows more time to plan and coordinate the attack. Once detected, speed and violence in the assault may also achieve surprise, but this is rarely true against a prepared enemy defense.

(b) ***Limit the Enemy's Freedom of Action.*** Fix the enemy in position. Block his routes of escape with indirect fires, maneuver forces, or both. Suppress his weapons systems, obscure his vision, and disrupt his command and control. Reconnaissance is continuous; leaders at every echelon are seeking out the enemy's dispositions, strengths, and weaknesses. Initially, these actions are directed toward supporting an attack by the lowest echelon. At some point, the leader of this unit must determine if he is able to achieve fire superiority and conduct the assault. If it is determined that the unit in contact has insufficient combat power to complete the destruction of the enemy, the leader focuses on fixing the enemy and reconnoitering to support the attack by the next higher echelon.

(c) ***Maintain Security.*** While attempting to take these actions against the enemy, the enemy is attempting to do the same. Do not assume the enemy that has been identified is alone; there may be mutually supporting positions or units. The planned envelopment or flank attack of one enemy position may move through the kill zone of another unit, or this maneuver may expose the flank of the assault force to fires from undetected positions.

(d) ***Concentrate Combat Power.*** Once contact is made, the plan must support the rapid concentration of combat power to fix and finish (destroy) the enemy. Leaders at each echelon plan to destroy the enemy within their capabilities. The combat potential of small units may be increased by ensuring each has the ability to request fire support. The company commander may retain a portion of the company as a mobile reserve to react quickly to enemy contact by one of the small units. If the unit or platoon cannot finish the enemy, the company commander determines how to fix or contain the enemy while concentrating his dispersed combat potential. He then develops an attack plan to destroy the enemy force. He may use the fixing force to support by fire and assault with another platoon(s), or he may use artillery and mortars to destroy the enemy. Each leader must report the results of his reconnaissance to support the company commander's planning. Leaders recommend effective support positions, good assault positions or directions of attack, and likely enemy weak points. The leader of the unit in contact should also identify good linkup points in case the preplanned points are not effective. In most cases, this leader should coordinate face to face with the company commander or the leader of the assault element before initiating the assault.

(5) ***Follow the Enemy.*** When the purpose of the operation is to locate the enemy's base camps or other fixed sites, the company commander's concept must avoid non-decisive

fights between small units. When friendly units locate small enemy units, they report and attempt to follow or track these units back to their base camps. The company commander must ensure that his concept does not risk the security of his force in the attempt to make undetected contact and track enemy units. Units following the enemy must be ready to react to enemy contact and avoid likely ambush situations. It may also be possible to track the enemy's movement through the AO by using stationary OPs as trail watchers to report enemy activity.

(6) ***Enter the Area of Operations.*** The company commander also decides how the company will enter its zone or area of operations, how to move once in the area, where to locate certain units or facilities, and what the requirements for contingency plans are. This includes establishing the proper graphic control measures to control the movement of the units, to provide for linkups between units, and to support the rapid concentration of the company's combat power. It also includes synchronizing the actions of the company and providing specific tasks or constraints to ensure subordinates understand what actions to take once they make contact with the enemy. The company may enter the area or zone by moving as a company then splitting up (Figure 4-6), by infiltrating platoon and section (Figure 4-7, page 4-30), or by air assault.

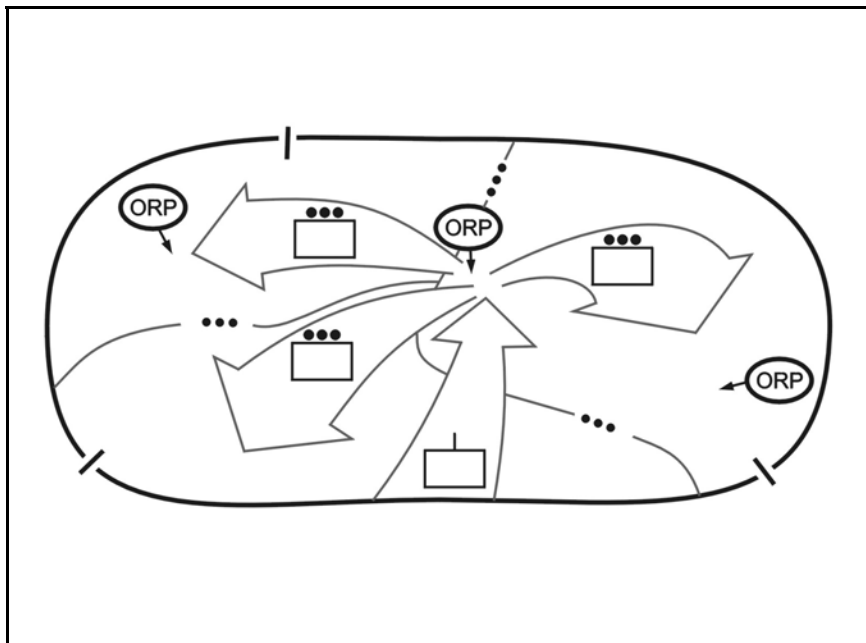

Figure 4-6. Infiltration by a company.

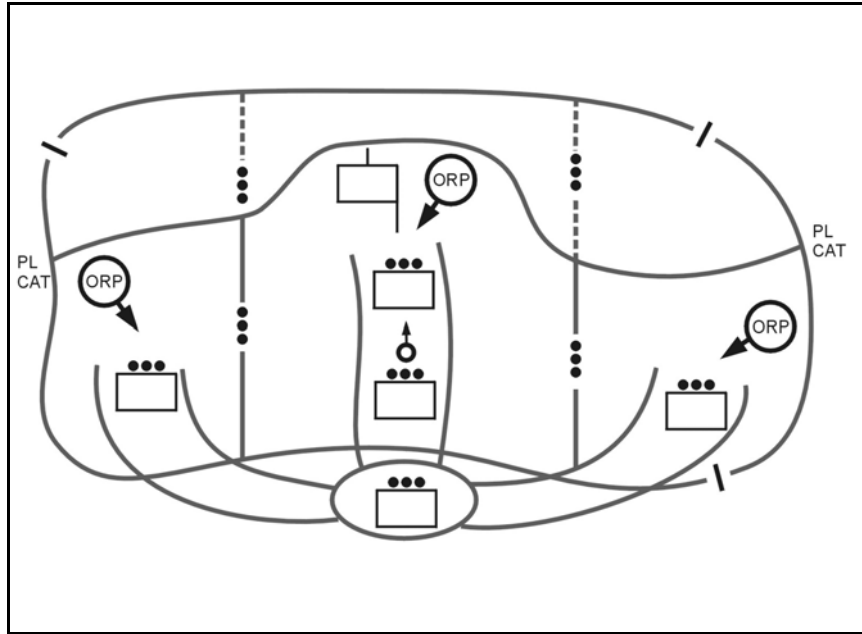

Figure 4-7. Infiltration by platoon and section.

(a) Movement within the area or through the zone of attack may be conducted by the entire company or by individual platoons. Figure 4-8 shows a concept sketch for a search and attack conducted without a company linkup.

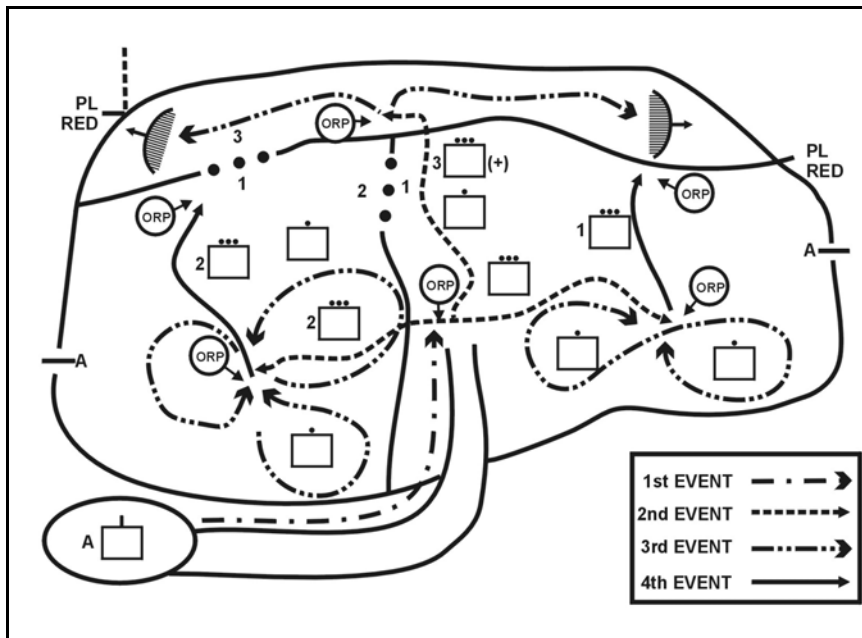

Figure 4-8. Antiarmor company search-and-attack concept sketch.

(b) The company commander must decide where to locate the company CP. He may collocate it with the main effort platoon, or he may position the CP in a central location where it can communicate with and move quickly to each platoon's location. A technique is

to rotate a platoon each day to provide security for the CP. Each platoon spends only 48 hours actively searching for the enemy and then rotates into this security role. This should prevent a serious degradation in effectiveness due to sleep loss. This platoon may be the company's reserve.

4-15. EXPLOITATION

A company normally takes part in exploitations as part of a larger force; however, all company commanders should prepare to exploit tactical success at the local level. Any action must be within the higher commanders' intent and concept of the operation.

4-16. PURSUIT

The objective of the pursuit is the total destruction of the enemy force. The antiarmor company (or platoon) may take part in a pursuit as part of a larger force or, because of its organic transportation, may task-organize a pursuit force that can close with and destroy the remnants of the enemy force.

CHAPTER 5

DEFENSIVE OPERATIONS

As the Army enters the 21st century and transforms to meet the ever-changing enemy, the antiarmor company and platoon must assume a greater role in the conduct of warfare on the modern battlefield. The antiarmor company (or platoon) contributes to success in the defense by employing long-range direct fires to destroy enemy armor and infantry forces with the TOW, M2 and MK19 fire. The antiarmor unit's mobility, heavy weaponry, and thermal observation devices define it as a key part of a larger unit's defense. The antiarmor unit can perform several missions in the defense. These missions include defend from a battle position(s) in the main battle area (MBA), participate in security operations, or serve as the reserve. The defense is a time management challenge for any unit and is continuously improved until the unit is attacked or receives a change of mission. The effectiveness of the defense depends on the efficiency of time management during planning, ISR operations, occupation, and preparation. This chapter describes the tactics and techniques used by antiarmor units in the defense and related security operations.

Section I. GENERAL PLANNING CONSIDERATIONS

Military forces conduct defensive operations only until they gain sufficient strength to attack. Though the outcome of decisive combat derives from offensive actions, commanders often find that it is necessary, even advisable, to defend. Once they make this choice, they must set the conditions for the defense in a way that allows friendly forces to withstand and hold the enemy while they prepare to seize the initiative and return to the offense. A thorough understanding of the commander's intent is especially critical in defensive operations, which demand precise integration of combat, combat support, and combat service support elements.

5-1. PURPOSE OF THE DEFENSE

The immediate purposes of all defensive operations are to defeat an enemy attack and gain the initiative for offensive operations. The antiarmor company (or platoon) may also conduct the defense to achieve one or more of the following purposes:

- Gain time.
- Retain key terrain.
- Support other operations.
- Preoccupy the enemy in one area while friendly forces attack him in another.
- Erode enemy forces at a rapid rate while reinforcing friendly operations.

5-2. CHARACTERISTICS OF THE DEFENSE

The characteristics of the defense--preparation, security, disruption, mass, concentration, and flexibility--are planning fundamentals for the antiarmor company (or platoon). There are two types of defensive operations: area and mobile. Traditionally, the light infantry applies the area defense pattern. Light infantry rarely applies a mobile defense pattern because it is less mobile than the enemy and lacks the ability to significantly maximize

the combat power available in a single credible force. Airborne and air assault battalions and SBCTs, with the enhanced mobility of the antiarmor company, have the capability to apply area or mobile defenses. All (or a portion) of the antiarmor company can be employed as the striking force within a mobile defense. The characteristics of the defense should be considered when planning or conducting company defensive operations. (See Chapters 9 and 10 in FM 3-90 for further discussion on mobile and area defenses.) These considerations, as they apply to the antiarmor company (or platoon), are as follows:

a. **Preparation.** The defender arrives in the battle area before the attacker. He must take advantage of this by making the most thorough preparations for combat that time allows. By analyzing the factors of METT-TC, the defender gains an understanding of the tactical situation and identifies potential friendly and enemy weaknesses. He then war-games friendly and enemy options and synchronizes his concept of the operation with all available combat multipliers.

b. **Security.** The goals of the antiarmor company (or platoon) security effort normally include providing early warning, destroying enemy reconnaissance units, and impeding and harassing enemy main body elements. The company (or platoon) continues its mission until directed to displace.

(1) Since the enemy (attacker) decides the time and place of the attack, the defender uses security measures to provide early warning. ISR and security operations must begin immediately upon transitioning to the defense and continue throughout the operation.

(2) Security forces protect friendly forces and allow them to continue their preparations. The defender may also use security forces in his deception effort to give the illusion of strength in one area while positioning his true combat power in another. While conducting this type of security operation, the antiarmor company (or platoon) may simultaneously need to prepare deception and real battle positions, creating a challenging time management problem for all of the leaders.

c. **Disruption.** Defensive plans vary with the circumstances, but all defensive concepts of operation aim at disrupting the attacker's synchronization. Counterattacks, indirect fires, obstacles, and retention of key or decisive terrain prevent the enemy from concentrating his strength against portions of the defense. Destroying enemy command and control vehicles disrupts enemy synchronization and flexibility.

d. **Mass and Concentration.** The defender must concentrate combat power at the decisive time and place if he is to succeed. He must obtain a local advantage at points of decision. Offensive action and the use of surprise and deception are often the means of gaining this advantage. The defender must remember that this concentration refers to combat power and its effects--not just numbers of soldiers and weapons systems. To concentrate combat power, the defender normally must economize in some areas, retain a reserve, and maneuver to gain local superiority. Local counterattacks may be needed to maintain the integrity of the defense. Indirect fire can be shifted to critical points to concentrate destructive effects rapidly.

e. **Flexibility.** Flexibility is derived from sound preparation and effective command and control. The defender must be agile enough to counter or avoid the attacker's blow and then strike back effectively. Flexibility results from a detailed mission analysis, an understanding of the unit's purpose, aggressive reconnaissance and security, and, when applicable, organization in depth and retention or reconstitution of a reserve. Supplementary positions on secondary avenues of approach may provide additional

flexibility to the unit. After a good analysis of the terrain and enemy, reserves can be positioned to allow the unit to react to unanticipated events.

Section II. SEQUENCE OF THE DEFENSE

As part of a larger element, the antiarmor company (or platoon), when augmented with additional combat support and combat service support elements, conducts defensive operations in a sequence of integrated and overlapping steps. The following paragraphs focus on the tactical considerations and procedures involved in each step. This discussion illustrates an attacking enemy that uses depth in its operations, but there will be situations where a company must defend against an enemy that does not have a doctrinal operational foundation. This requires a more flexible plan that allows for more centralized combat power rather than spreading it throughout the company's area of operations.

5-3. RECONNAISSANCE AND SECURITY OPERATIONS AND ENEMY PREPARATORY FIRES

Security forces must protect friendly forces in the MBA and allow them to continue their defensive preparations. The enemy will attempt to discover the defensive scheme of maneuver using reconnaissance elements or attacks by forward detachments and advance guard elements. He will also attempt to breach the higher unit's tactical obstacles.

a. The goals of the security force normally include providing early warning, destroying enemy reconnaissance units, and impeding and harassing enemy main body elements. The security force continues its mission until directed to displace. The higher commander may also use security forces in his deception effort to give the illusion of strength in one area while positioning his true combat power in another. While conducting this type of security operation, the antiarmor company (or platoon) may also prepare battle positions, creating a challenging time management problem.

b. During this step, the antiarmor company (or platoon) may need to provide guides to a passing force and may be tasked to close passage lanes. The unit may also play a role in shaping the battlefield. The battalion or brigade (or SBCT) commander may position the unit to deny likely enemy attack corridors, enhancing flexibility and forcing enemy elements into friendly engagement areas. When it is not conducting security or preparation tasks, the company (or platoon) may occupy hide positions to avoid possible enemy artillery preparation. The unit's efforts must reinforce and complement the higher unit's ISR and security plans.

5-4. OCCUPATION AND PREPARATION

During this step, the company reconnoiters and occupies its positions. This usually includes movement from tactical assembly areas to the actual defensive sector, led by a quartering party that clears the defensive positions. The higher units establish security forces during this step, and remaining forces begin to develop engagement areas and prepare battle positions. Security is critical during the occupation to ensure the unit can avoid detection and maintain combat power for the actual defense. Soldiers at all levels must thoroughly understand their duties and responsibilities related to the occupation; they must be able to execute the occupation quickly and efficiently to maximize the time

available for planning and preparation of the defense. (See Appendix D, Firing Positions.)

5-5. APPROACH OF THE ENEMY MAIN ATTACK

As this step begins, the brigade (or SBCT) engages the enemy at long ranges using indirect fires, electronic warfare, and close air support (CAS) (deep fight). The goal is to use these assets, along with disrupting obstacles, to shape the battlefield and to slow the enemy's advance and disrupt his formations. As the enemy's main body echelon approaches the company or battalion engagement area, it may initiate indirect fires and CAS to further weaken the enemy; at the same time, the brigade's (or SBCT's) shaping operation normally shifts to second-echelon forces. Friendly forces occupy their actual defensive positions before the enemy reaches direct fire range; they may shift positions in response to enemy actions or other tactical factors.

5-6. ENEMY ASSAULT

During this step, the enemy deploys to achieve mass at a designated point, normally employing both assault and support forces. This may leave him vulnerable to the combined effects of indirect and direct fires integrated with obstacles. He may employ additional forces to fix friendly elements and prevent their repositioning. Friendly counterattack forces may be committed against the enemy flank or rear, while other friendly forces may displace to alternate, supplementary, or successive positions in support of the higher commander's scheme of maneuver. All friendly forces should be prepared for the enemy to maximize employment of combat multipliers, such as dismounted infantry operations, to create vulnerability. The enemy is also likely to set the conditions for the assault with artillery, CAS, and chemical weapons.

5-7. COUNTERATTACK

As the enemy's momentum is slowed or stopped, friendly forces may conduct a counterattack. The counterattack may be conducted purely for offensive purposes to seize the initiative from the enemy. In some cases, however, the purpose of the counterattack is mainly defensive, such as reestablishing a position or restoring control of the sector. The antiarmor company (or platoon) may participate in the counterattack by providing support by fire for the counterattack force or as the actual counterattack force.

5-8. CONSOLIDATION AND REORGANIZATION

The antiarmor company (or platoon) must secure its sector by repositioning forces, destroying remaining enemy elements, processing enemy prisoners of war (EPWs), and reestablishing obstacles. The unit conducts all necessary CSS functions as it prepares to continue the defense. Even when enemy forces are not actively engaging it, the unit must maintain local security at all times during consolidation and reorganization. The unit then must prepare itself for possible follow-on missions.

Section III. BOS PLANNING CONSIDERATIONS

The BOS are a listing of critical tactical activities and provide a means of reviewing preparations or execution. The synchronization and coordination of activities within and among the various BOS are critical to the success of the antiarmor company (or platoon).

5-9. MANEUVER

The goal of effective weapons positioning is to enable the antiarmor company (or platoon) to mass direct fires at critical points on the battlefield and to enhance its survivability. To do this, the commander (or platoon leader) must maximize the strengths of his weapons systems (TOW, M2, and MK19) while minimizing the company's exposure to enemy observation and fires. The following paragraphs focus on tactical considerations for weapons positioning.

a. **Depth and Dispersion.** Dispersing positions laterally and in depth helps to protect the force from enemy observation and fires. If the terrain allows for the development of an engagement area (EA), the positions are established in depth, allowing sufficient maneuver space within each position to establish in-depth placement of vehicles and weapons systems. Fighting positions should be positioned to allow the massing of direct fires at critical points on the battlefield.

b. **Flank Positions.** Flank positions enable a defending force to bring fires to bear on an attacking force moving parallel to the defender's forces. An effective flank position provides the defender with a larger and more vulnerable target while leaving the attacker unsure of the location of the defense. Major considerations for successful employment of a flank position are the defender's ability to secure the flank and his ability to achieve surprise by remaining undetected. Effective fire control (refer to Appendix C) and fratricide avoidance measures (refer to Appendix B) are critical considerations in the employment of flank positions.

c. **Displacement Planning.** Disengagement and displacement allow the company to retain its operational flexibility and tactical agility in the defense. The ultimate goals of disengagement and displacement are to enable the antiarmor company (or platoon) to maintain standoff ranges and to avoid being fixed or decisively engaged by the enemy. The commander (or platoon leader) must consider several important factors in displacement planning. These include, but are not limited to, the following:

- The enemy situation (for example, an attack with two battalion-size enemy units may prevent the unit from disengaging).
- Disengagement criteria.
- Availability of indirect fires that can support disengagement by suppressing or disrupting the enemy.
- Availability of cover and concealment and smoke to assist disengagement.
- Obstacle integration (including situational obstacles).
- Positioning of forces on terrain that provides an advantage to the disengaging elements (such as reverse slopes or natural obstacles).
- Identification of displacement routes and times when disengagement or displacement will take place. Routes and times are rehearsed.
- The size and composition of a friendly force that must be available to engage the enemy in support of the displacing unit.

While disengagement and displacement are valuable tactical tools, they can be extremely difficult to execute in the face of a rapidly moving enemy force. In fact, displacement in contact poses such great problems that the antiarmor company commander (or platoon leader) must plan for it thoroughly and rehearse displacement before the conduct of the defense. Then he must carefully evaluate the situation at the time displacement in contact

becomes necessary to ensure that it is feasible and will not result in unacceptable loss of personnel or equipment.

d. **Disengagement Criteria.** Disengagement criteria dictate to subordinate elements the circumstances under which they will displace to an alternate, supplementary, or successive battle position (BP). The criteria are tied to an enemy action (for example, disengage when greater than five enemy armored vehicles advance past PL DOG) and are linked to the friendly situation (for example, they may depend on whether artillery or an overwatch element can engage the enemy). Disengagement criteria are developed during the planning process based on the unique conditions of a specific situation; they should never be part of the unit's SOP.

e. **Direct Fire Suppression.** The attacking enemy force must not be allowed to bring effective direct and indirect fires to bear on a disengaging friendly force. Direct fires from the supporting element, employed to suppress or disrupt the enemy, are the most effective way to facilitate disengagement. The company (or platoon) may receive supporting fires from another element. In most cases, however, the antiarmor company (or platoon) establishes its own supporting element. Having an internal element requires the company commander (or platoon leader) to carefully sequence the displacement of his forces.

f. **Cover and Concealment.** Ideally, the company (or platoon) and subordinate units should use covered and concealed routes when moving to alternate, supplementary, or successive BPs. Regardless of the degree of protection the route itself affords, all of the units should rehearse the movement. Rehearsals increase the speed at which the unit can conduct the move, providing an added measure of security. The commander or leader must make a concerted effort to allocate available time to rehearse movement in limited visibility and degraded conditions.

g. **Indirect Fires and Smoke.** Artillery or mortar fires can assist the unit during disengagement. Suppressive fires, placed on an enemy force as it is closing inside the defender's standoff range, slow the enemy and cause him to button up. The defending force engages the enemy with long-range precision direct fires and then disengages and moves to new positions. Smoke can obscure the enemy's vision, slow his progress, or screen the defender's movement out of the BP or along his displacement route.

h. **Obstacle Integration.** Obstacles must be integrated with direct and indirect fires. By slowing and disrupting enemy movement, obstacles provide the defender with the time necessary for displacement and allow friendly forces to employ direct and indirect fires effectively against the enemy. The modular pack mine system (MOPMS) can also be employed in support of the disengagement, either to block a key displacement route once the displacing unit has passed through it or to close a lane through a tactical obstacle. The location of obstacles in support of disengagement depends in large measure on an analysis of the factors of METT-TC. A major consideration for employing an obstacle is that it should be positioned far enough away from the defender that he can effectively engage the enemy on the far side of the obstacle while remaining out of range of the enemy's direct fires.

5-10. FIRE SUPPORT

For the indirect fire plan to be effective in the defense, the unit must plan and execute fires in a manner that achieves the intended task and purpose of each target. Indirect fires serve a variety of purposes in the defense, including the following:

- Slow or disrupt enemy movement.
- Prevent the enemy from executing breaching.
- Destroy or delay enemy forces at obstacles using massed fires or pinpoint munitions.
- Disrupt enemy support-by-fire elements.
- Defeat attacks along infantry avenues of approach with the use of final protective fire (FPF).
- Allow friendly elements to disengage or conduct counterattacks.
- Use smoke to screen friendly displacement or to silhouette enemy formations, facilitating direct fire engagement.
- Deliver scatterable mines to close lanes and gaps in obstacles, to disrupt or prevent enemy breaching operations, to disrupt enemy movement at choke points, or to separate or isolate enemy echelons.
- Execute suppression of enemy air defense (SEAD) missions to support CAS, attack aviation, and high-payoff targets.
- Provide illumination (if necessary).

a. **Fire Support Assets.** In developing the indirect fire plan, the antiarmor company commander (or platoon leader) must evaluate the indirect fire systems available. Considerations include tactical capabilities, weapons ranges, and available munitions. These factors help him and the battalion or company (SBCT) FSO to determine the best method for achieving the task and purpose of each target in the fire plan.

b. **FIST Positioning.** The SBCT antiarmor company's FIST contributes significantly to the fight; its effective positioning is critical. The company commander and his company FSO must select positions that provide fire support personnel with unobstructed observation of the area of operations. In addition, the fire support vehicle should receive high priority for a position with enhanced survivability. The airborne, air assault companies, and antiarmor platoon (light infantry battalion) do not have a FIST and must rely on the battalion FSO for support.

5-11. AIR DEFENSE

The focus of the air defense plan is on likely air avenues of approach for enemy fixed-wing aircraft, rotary-wing aircraft, and unmanned aerial vehicle (UAV); these may or may not correspond with the enemy's ground avenues of approach. Air defense assets that are available to the antiarmor company (or platoon) are positioned based on the results of an analysis of the factors of METT-TC and the higher commander's scheme of maneuver.

a. Air defense assets, for example, are usually positioned about 2 kilometers apart to maximize the Stinger's capabilities in the defense. The Stinger then becomes the primary killer of rotary-wing and fixed-wing aircraft, with combined-arms air defense (small arms and vehicle-mounted weapons systems) for close-in defense.

b. In another situation, the higher headquarters S2 and air defense officer (ADO) may determine that the air defense systems should be positioned independent of the

friendly ground maneuver elements. These systems also are used frequently to protect friendly counterattack forces against aerial observation or attack.

c. Another factor in air defense planning is the resupply of Stinger missiles, which places unique demands on the antiarmor company (or platoon) and requires detailed planning and consideration. It may be necessary to pre-position Stingers in the company (or platoon) AO to facilitate timely resupply.

5-12. MOBILITY, COUNTERMOBILITY, AND SURVIVABILITY

Mobility focuses on preserving the freedom of maneuver of friendly forces. Countermobility limits the maneuver of enemy forces and enhances the effectiveness of fires. Survivability focuses on protecting friendly forces from the effects of enemy weapon systems.

a. **Mobility.** During defensive preparations, mobility operations initially focus on the ability to resupply, reposition, and conduct rearward and forward passage of forces, material, and equipment. Once defensive preparations are complete, the focus normally shifts to supporting the unit's reserve, local counterattacks, and the higher HQ counterattack or reserve. Priorities set by the higher HQ may specify routes for improvement in support of such operations. Normally, all or most of the available engineer assets are allocated to the survivability and countermobility efforts until defensive preparations are complete. Then, at a designated time (or trigger) engineers disengage from obstacle and survivability position construction and begin preparing for focused mobility operations.

b. **Survivability.** Light, airborne, air assault, and SBCT engineer companies are limited in organic earthmoving equipment. They are capable of preparing hasty fighting positions and improving reverse-slope positions during the transition to a hasty defense, but to construct survivability positions for a deliberate defense, the engineer company requires equipment augmentation. Thus, it is critical that these units maximize the effects of terrain when selecting positions for key weapons and vehicles.

(1) Survivability positions are prepared in BPs or strongpoints to protect weapons systems and vehicles. Positions can be constructed and reinforced with overhead cover to provide crew-served weapons with protection against shrapnel from airbursts. The antiarmor company commander (or platoon leader) prepares the area of operation for the arrival of the earthmoving equipment by marking positions and designating guides for the engineer vehicles. If time is available, vehicle positions are constructed with both hull-defilade firing positions and full-defilade positions.

(2) In addition, the unit may use digging assets for ammunition caches at alternate, supplementary, or successive BPs or in individual vehicle positions. If the unit is defending as part of a larger force, the process of digging in all the assets requires many "blade hours." With this limited available time, the higher headquarters allocates specific equipment, by type and time, to its subordinate units. The antiarmor company commander (or platoon leader) has the following responsibilities:

- Know the number of blade hours and positions (vehicle and individual) he requires.
- Understand the number of blade hours and positions allocated to him.
- Prepare a prioritized plan based on his analysis of "required" versus "available."

The company commander (or platoon leader) may have time to dig in only those positions that have the least amount of natural cover and concealment. Soil composition should also be a consideration in BP selection; sites to be avoided include those where the soil is overly soft, hard, wet, or rocky. However, supporting the direct fire plan must be the main consideration. It is critical that all leaders within the unit understand the following:

- The survivability plan and priorities.
- One leader within the company is specifically designated to enforce the plan and priorities.
- Completion status is accurately reported and tracked.

c. **Countermobility.** To be successful in the defense, the antiarmor company commander (or platoon leader) must integrate individual obstacles into both direct and indirect fire plans, taking into account the intent of each obstacle group. At the brigade (or SBCT) level, obstacle intent consists of the target of the obstacle group, the desired effect on the target, and the relative location of the group. In addition, like artillery and mortar employment, each obstacle emplaced must have a clear task and purpose. The purpose influences many aspects of the operation, from selection and design of obstacle sites to actual conduct of the defense. Normally, the battalion or brigade (or SBCT) designates the purpose of an obstacle group. (Refer to FM 90-7 for additional information on obstacle planning, siting, and turnover.)

(1) **Tactical Obstacles.** The higher HQ designs and resources tactical obstacle groups and assigns them to subordinate units. The higher commander provides obstacle-planning guidance, in terms of obstacle intent, to commanders, selected leaders, and the engineer. Obstacle intent includes the target (enemy force), the desired effect (on the target), and the relative location (relative to terrain, enemy, and friendly) of the unit's assigned obstacle group.

EXAMPLE: An air assault infantry battalion commander might specify this purpose: "We must deny the enemy access to our flank by turning the northern, first-echelon motorized rifle battalion (MRB) into our engagement area, allowing Companies B and D to mass their fires to destroy it".

Table 5-1, page 5-10, shows the symbology for each obstacle effect and describes the purpose and characteristics inherent in each.





OBSTACLE EFFECT	PURPOSE	FIRES AND OBSTACLES MUST:	OBSTACLE CHARACTERISTICS
 <p>DISRUPT ①</p>	<p>Breakup enemy formations. Interrupt the enemy's timetable and C2. Cause premature commitment of breach assets. Cause the enemy to piecemeal his attack.</p>	<p>Cause the enemy to deploy early. Slow part of his formation while allowing part to advance unimpeded.</p>	<p>Do not require extensive resources. Difficult to detect at long range.</p>
 <p>FIX ②</p>	<p>Slow an attacker within an area so he can be destroyed. Generate the time necessary for the friendly force to disengage.</p>	<p>Cause the enemy to deploy into attack formation before encountering the obstacles. Allow the enemy to advance slowly in an EA or AO. Make the enemy fight in multiple directions once he is in the EA or AO.</p>	<p>Arrayed in depth. Span the entire width of the avenue of approach. Must not make the terrain appear impenetrable.</p>
 <p>TURN ③</p>	<p>Force the enemy to move in the direction desired by the friendly commander.</p>	<p>Prevent the enemy from bypassing or breaching the obstacle belt. Maintain pressure on the enemy force throughout the turn. Mass direct and indirect fires at the anchor point of the turn.</p>	<p>Tie into impassable terrain at the anchor point. Consist of obstacles in depth. Provide a subtle orientation relative to the enemy's approach.</p>
 <p>BLOCK ④</p>	<p>Stop an attacker along a specific avenue of approach. Prevent an attacker from passing through an AO or EA. Stop the enemy from using an avenue of approach and force him to use another avenue of approach.</p>	<p>Prevent the enemy from bypassing or penetrating through the belt. Stop the enemy's advance. Destroy all enemy breach efforts.</p>	<p>Must tie into impassable terrain. Consist of complex obstacles. Defeat the enemy's mounted and dismounted breaching effort.</p>

Table 5-1. Obstacle effects.

(2) **Protective Obstacles.** Individual units are responsible for planning and constructing protective obstacles. To be most effective, a unit should tie these into the terrain and into existing tactical obstacles. It may use mines and wire from its basic load or receive additional materiel (including MOPMS, if available) from the higher unit Class IV or V supply point. It may also be responsible for any other required coordination (such as that needed in a relief in place), for recovery of the obstacle, or for its destruction (as in the case of MOPMS). FM 90-7 provides detailed information on protective obstacle emplacement.

(a) In planning for protective obstacles, the commander (or platoon leader) must evaluate the potential threat to the unit's position and then employ the appropriate system to counter that threat. For example, MOPMS is predominantly an antitank system best used on mounted avenues of approach, but it does have some antipersonnel applications. Wire obstacles, on the other hand, may be most effective when employed on dismounted avenues.

(b) Protective obstacles are usually located beyond hand grenade distance (40 to 100 meters) from the fighting position and may extend out 300 to 500 meters to tie into tactical obstacles and existing restricted (or severely restricted) terrain. As with tactical obstacles, the commander (or platoon leader) should plan protective obstacles in depth and attempt to maximize the effective range of his weapons systems.

(c) When planning protective obstacles, the company commander (or platoon leader) should consider the amount of time required to prepare them, the burden on the logistical

system, and the risk of the enemy detecting the obstacles and the resulting loss of surprise.

(3) **Wire Obstacles.** There are three types of wire obstacles (Figure 5-1): protective wire, tactical wire, and supplementary wire.

(a) Protective wire may be a complex obstacle providing all-round protection of a platoon perimeter, or it may be a simple wire obstacle on the likely dismounted avenue of approach into an antiarmor ambush position. Command-detonated M18 Claymore mines may be integrated into the protective wire or used separately.

(b) Tactical wire is positioned to increase the effectiveness of the company's direct fires and supporting indirect fires. Tactical minefields may also be integrated into these wire obstacles or be used separately.

(c) Supplementary wire obstacles are used to break up the line of tactical wire to prevent the enemy from locating friendly weapons systems by following the tactical wire.

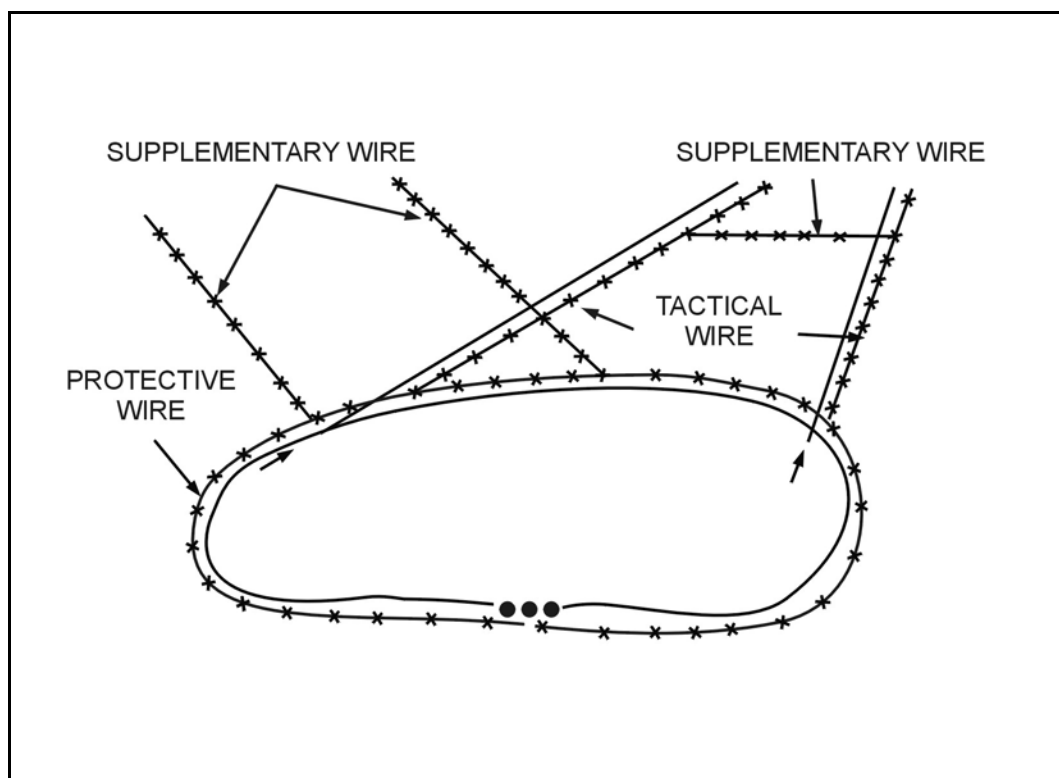

Figure 5-1. Wire obstacles.

(4) **Obstacle Lanes.** The unit may be responsible for actions related to lanes through obstacles. These duties may include marking lanes in an obstacle, reporting locations of the start and end points of each lane, manning contact points, providing guides for elements passing through the obstacle, and closing the lane.

5-13. COMBAT SERVICE SUPPORT

In addition to the CSS functions required for all operations (Chapter 11), the antiarmor company commander's (or platoon leader's) planning process should include the considerations highlighted in the following paragraphs.

a. **Pre-Positioning and Caches.** His mission analysis may reveal that the unit's ammunition needs during an upcoming operation exceed its basic load. This requires the unit to pre-position ammunition (caches). The caches, which may be positioned either at an alternate or successive BP or in the vehicles firing position, should be both dug in and guarded.

b. **Position of Trains.** The antiarmor company trains normally operate one terrain feature to the rear of the company or positioned, based upon the factors of METT-TC, to provide immediate recovery, medical, and maintenance support. The commander must also ensure that all subordinate elements know the locations of the higher HQ forward and main aid stations and that the elements plan and rehearse casualty evacuation procedures. The antiarmor platoon from a light infantry battalion will receive support from the CTCP or from the company to which it is attached.

Section IV. PREPARATION AND INTEGRATION

The antiarmor company commander's (or platoon leader's) analysis determines the most effective control measures for every mission. This section describes the techniques and planning considerations available to the company commander (or platoon leader) as he prepares his defense.

5-14. DEFENSIVE TECHNIQUES

The antiarmor company (or platoon) typically defends using one of these basic defensive techniques:

- Defend in sector.
- Defend from a battle position.
- Defend on a reverse slope.

The control measures for the defense are sectors, battle positions, or a combination of these. There are no set criteria for selecting the control measures, but Table 5-2 provides some basic considerations.

BATTLE POSITION		SECTOR
WELL-DEFENDED; ENEMY CAN BE CANALIZED	← AVENUES OF APPROACH →	NOT EASILY DEFINED
DOMINATES AVENUES OF APPROACH	← TERRAIN →	DOMINATING TERRAIN NOT AVAILABLE
NARROW/SMALL	← UNIT AREA OF OPERATIONS →	WIDE/LARGE
ACHIEVABLE	← MUTUAL SUPPORT →	CANNOT EASILY BE ACHIEVED
GOOD	← COMMANDERS' ABILITY TO SEE/CONTROL →	DEGRADED
RETAIN, BLOCK	← ASSIGNED TASK →	DISRUPT, CONTAIN

Table 5-2. Selecting control measures.

a. **Defend in Sector.** A sector is the control measure that provides the most freedom of action to a subordinate unit. It provides flexibility by allowing the subordinate unit to operate in a decentralized manner while still maintaining sufficient control to prevent confusion and to synchronize the higher unit's operation.

(1) An antiarmor company's disposition may consist of platoon sectors, a series of mutually supporting battle positions on restricted terrain, or a combination of the two. Figure 5-2, page 5-14, depicts an SBCT antiarmor company defending in sector with two platoons defending in sector and one platoon defending from a battle position. Positions are arrayed in depth. The strength of this defense comes from its flexibility. This defense normally orients on the enemy force and not on retaining terrain. It is effective because it forces the enemy to expose his flanks and critical C2 and CS assets through his own maneuver into the depth of the defense.

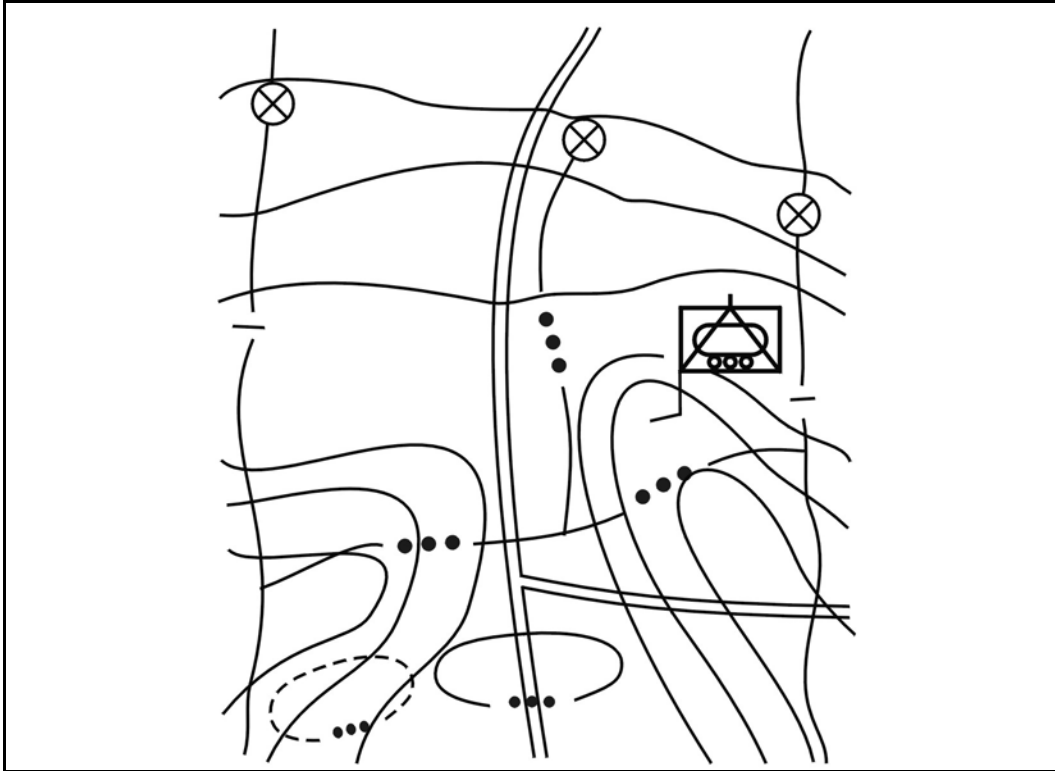

Figure 5-2. SBCT antiarmor company defense in sector, with a platoon in a battle position.

(2) By assigning platoon sectors, the company may fight a defense in sector very similar to a nonlinear defense (see FM 7-10). This decentralized defense requires greater initiative and delegates more of the control to subordinate leaders. When required, subordinate units may disengage independently and move to another location within the sector to continue the fight. Considerations for an antiarmor company reconnaissance and security plan and employment of a reserve are also very similar to the nonlinear defense.

(3) When fighting an antiarmor company defense in sector from platoon BPs, the goal is to defeat the attacker through the depth of his formation by confronting him with effective fires from mutually supporting battle positions as he attempts to maneuver around them. Observation posts, indirect fire targets, mines, and other obstacles cover gaps that, because of terrain masking or heavy woods, cannot be covered effectively by direct fire. Units remain in place except for local or internal movement to alternate or supplementary positions. If certain platoon positions become untenable during the battle, the antiarmor company commander may withdraw the platoons to successive positions according to prepared plans and rehearsals.

(a) One technique is to allow the enemy to move into the engagement area and destroy him with massed fires.

(b) Another technique is to engage the attacker at maximum range with fires from attack helicopters, field artillery, and mortars and then to engage with organic weapons systems positioned to deliver fires at maximum effective ranges from the flanks and rear. As the enemy closes, weapons systems may move to alternate or supplementary firing positions within the BP to continue firing and avoid being bypassed.

(4) The antiarmor company defense in sector, with platoons in battle position, generally requires the company commander to be able to see and control the battle. It also requires good fields of fire to allow mutual support. If the terrain or the expected enemy course of action prevents this, the defense may be more effective if control is more decentralized and the platoons fight in sector.

(5) A significant concern, particularly when fighting with platoon(s) in battle position within the company defense in sector, is the enemy's ability to isolate a part of the antiarmor company and then fix, destroy, or bypass it. Without effective mutual support between the battle positions, this is likely to occur. Even with mutual support, responsive and effective indirect fire support may be critical to defending the battle positions. Without immediately available fire support, a capable enemy will quickly concentrate combat power against any battle position that is identified.

b. **Defend from a Battle Position.** A battle position is a general location and orientation of forces on the ground from which units defend. The unit is located within the general area of the battle position. Security elements may be located forward and to the flanks of the battle position. Units defending from a battle position may not be tied in with adjacent units; thus, the requirement for all-round security is increased. When assigning battle positions, the company commander assigns sectors of fire and primary positions to his platoons to defend. Each position must contribute to the accomplishment of the company's assigned task and purpose within the higher commander's concept of the operation. A commander may also assign alternate, supplementary, and successive positions to platoons, depending on the situation.

(1) An alternate position is a position to the front, flank, or slightly to the rear of the primary position. Figure 5-3, page 5-16, depicts a platoon alternate position to the rear of its primary position. The alternate position must allow the unit to cover the same sector of fire as the primary position. If it is to be occupied during limited visibility, it may be forward of the primary position. The alternate position may be occupied if the unit is driven out of the primary position by enemy fire or by assault, or it may be occupied to begin the fight to deceive the enemy of the unit's primary position.

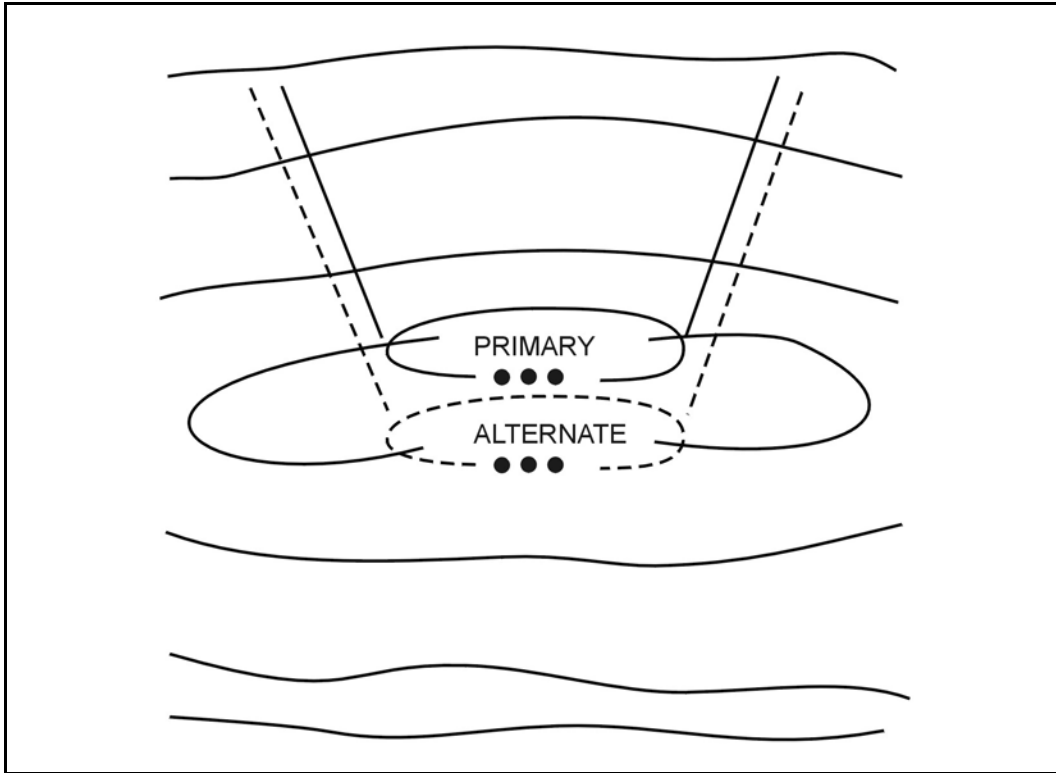

Figure 5-3. Alternate position.

(2) A supplementary position is to the flank or the rear of the primary position. It allows the unit to defend against an attack on an avenue of approach not covered by the primary position (Figure 5-4). It can be assigned when the unit must cover more than one avenue of approach. A unit moves from its primary, alternate, or supplementary position only with the higher commander's approval or when a condition exists that the higher commander has prescribed as a reason to move.

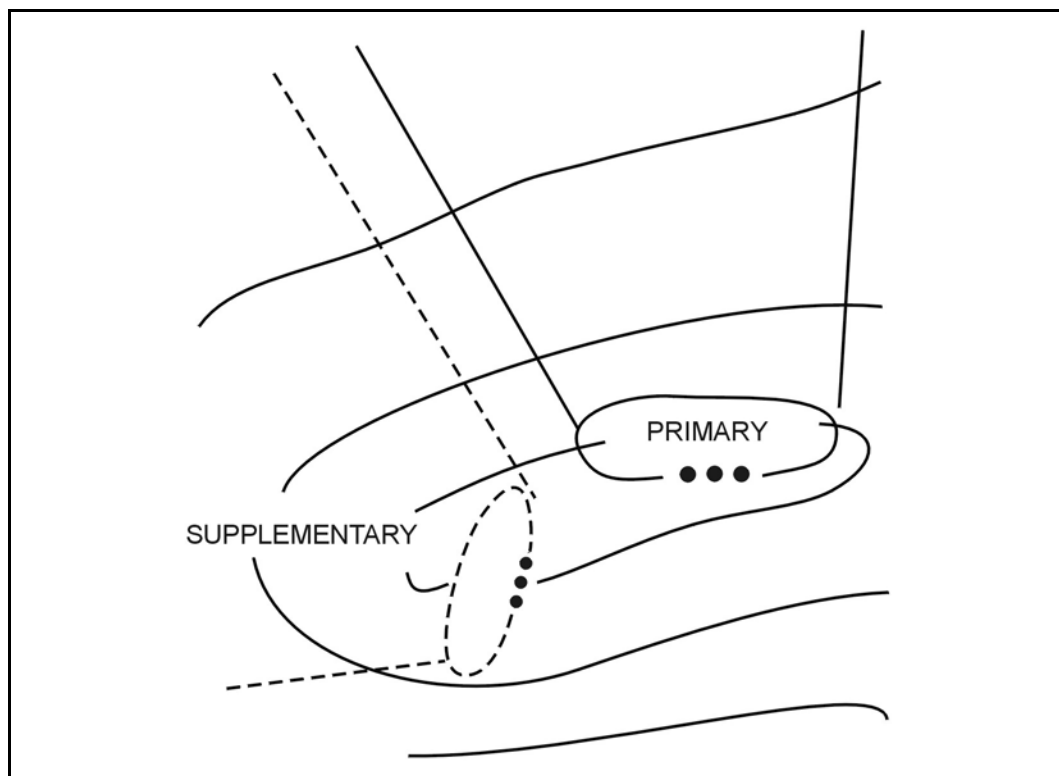

Figure 5-4. Supplementary position.

(3) Fighting from a battle position is a more centralized technique and also may be more linear at the company level. Even so, it should not be a static defense. Battle positions should be positioned to achieve surprise and to allow maneuver within and between battle positions. Figure 5-5, page 5-18, depicts an SBCT antiarmor company defending from mutually supporting battle positions. A defense from battle positions is effective in concentrating combat power into an engagement area. It prevents the enemy from isolating one part of the company and concentrating his combat power in this area. Normally, subordinate platoons are assigned mutual supporting battle positions that cover the enemy's likely avenue of approach. These battle positions are located on terrain that provides cover and concealment.

(4) A company commander's concept for fighting this defensive technique should concentrate on achieving surprise for each of the battle positions. This is accomplished by conducting an effective counterreconnaissance to prevent the enemy from locating the battle positions and by initiating fires from one battle position and waiting for the enemy to react to this engagement prior to engaging from the other battle positions. Fighting in this manner confuses the enemy and disrupts his C2.

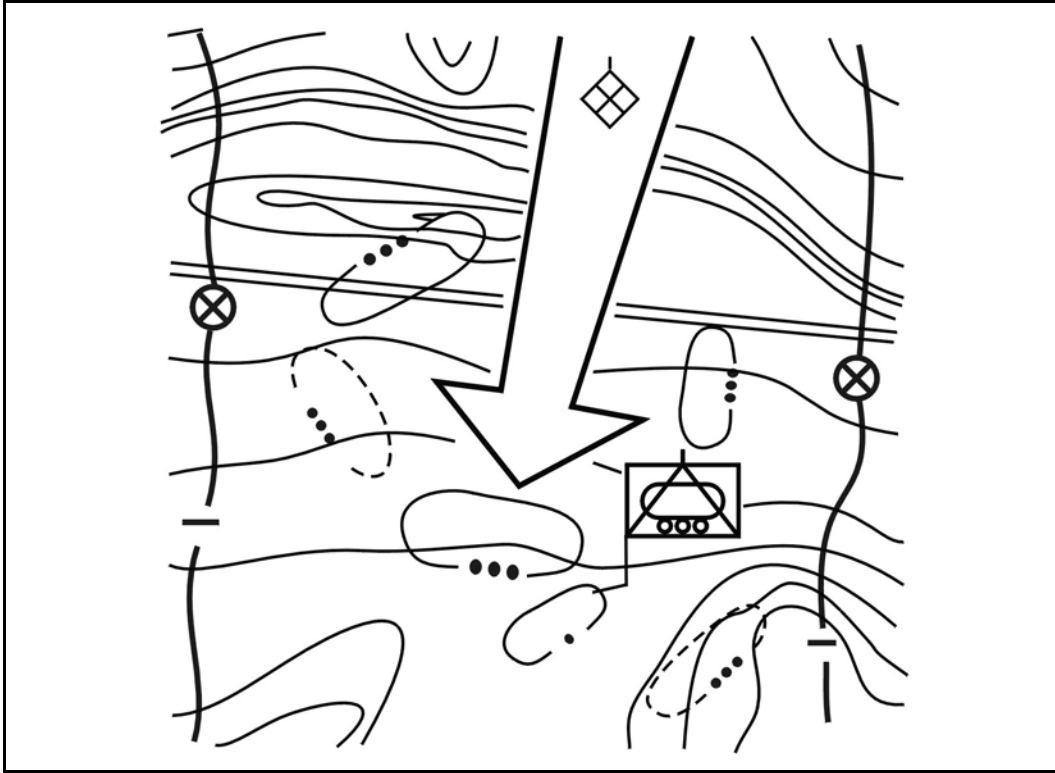

Figure 5-5. SBCT antiarmor company defense from mutually supporting battle positions.

(5) When the terrain permits and the antiarmor company commander's concept allows most of the enemy into the engagement area, the company may engage with massed fires from all of the platoon battle positions. A disadvantage to this technique is that if there are still uncommitted enemy forces outside the engagement area, they will know the locations of the BPs and will attempt to isolate and concentrate against them. The company commander (or platoon leader) must develop contingency plans to disengage from these battle positions and reorganize to continue the fight. This may involve displacing to alternate battle positions or disengaging to conduct counterattacks or spoiling attacks against identified enemy C2, CS, or CSS assets.

(6) Instead of one company engagement area, multiple platoon engagement areas may be identified to provide flexibility to the plan (Figure 5-6). The plan must clearly state which platoons must reorient fires into the alternate engagement area and when they must do so. This technique is especially effective when operating in restrictive terrain or in a complex environment.

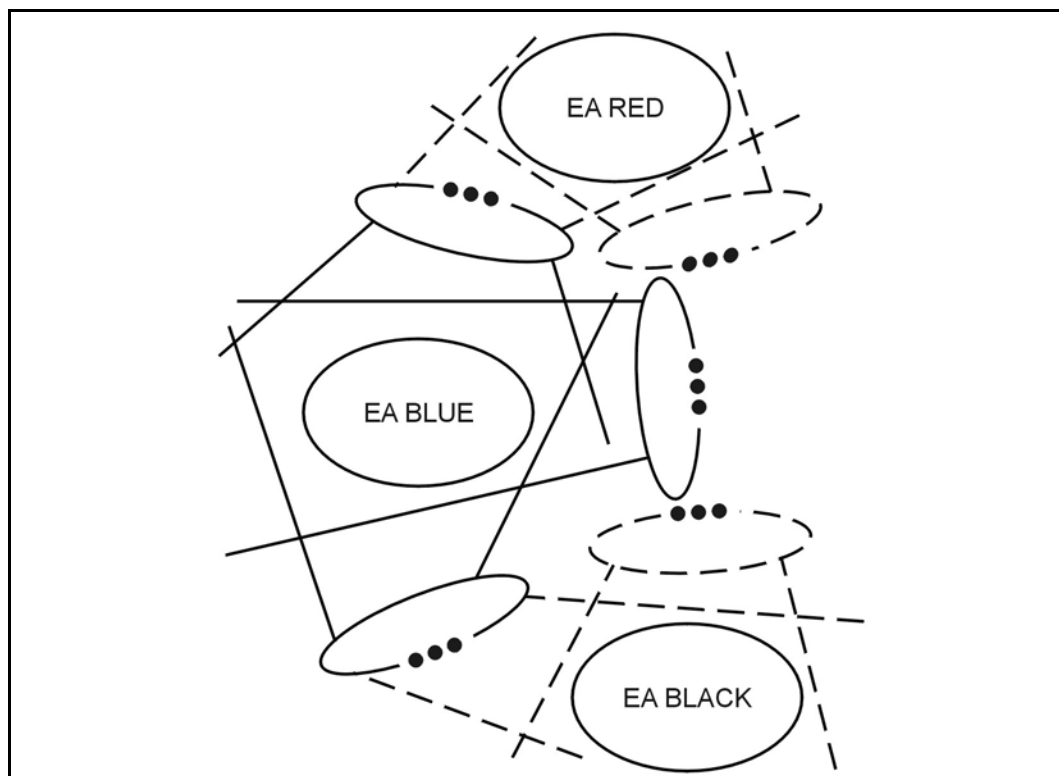

Figure 5-6. Multiple engagement areas.

c. **Defend on a Reverse Slope.** An alternative to defending on the forward slope of a hill or a ridge is to defend on a reverse slope. Figure 5-7, page 5-20, depicts an airborne antiarmor company with two infantry platoons in a reverse slope defense. In such a defense, the company (or platoon) is deployed on terrain that is masked from enemy direct fire and ground observation by the crest of a hill. Although some units and weapons may be positioned on the forward slope, the crest, or the counterslope (a forward slope of a hill to the rear of a reverse slope), most forces are on the reverse slope. The key to this defense is control of the crest by direct fire.

(1) **General Considerations.** These considerations generally apply when defending on a reverse slope.

(a) The crest protects the unit from direct fire. This is a distinct advantage if the attacker has greater weapons range than the defender. The reverse slope defense can eliminate or reduce the attacker's standoff advantage. It also makes enemy adjustment of his indirect fire more difficult since he cannot see his rounds impact. It keeps the enemy's second echelon from supporting his first echelon's assault.

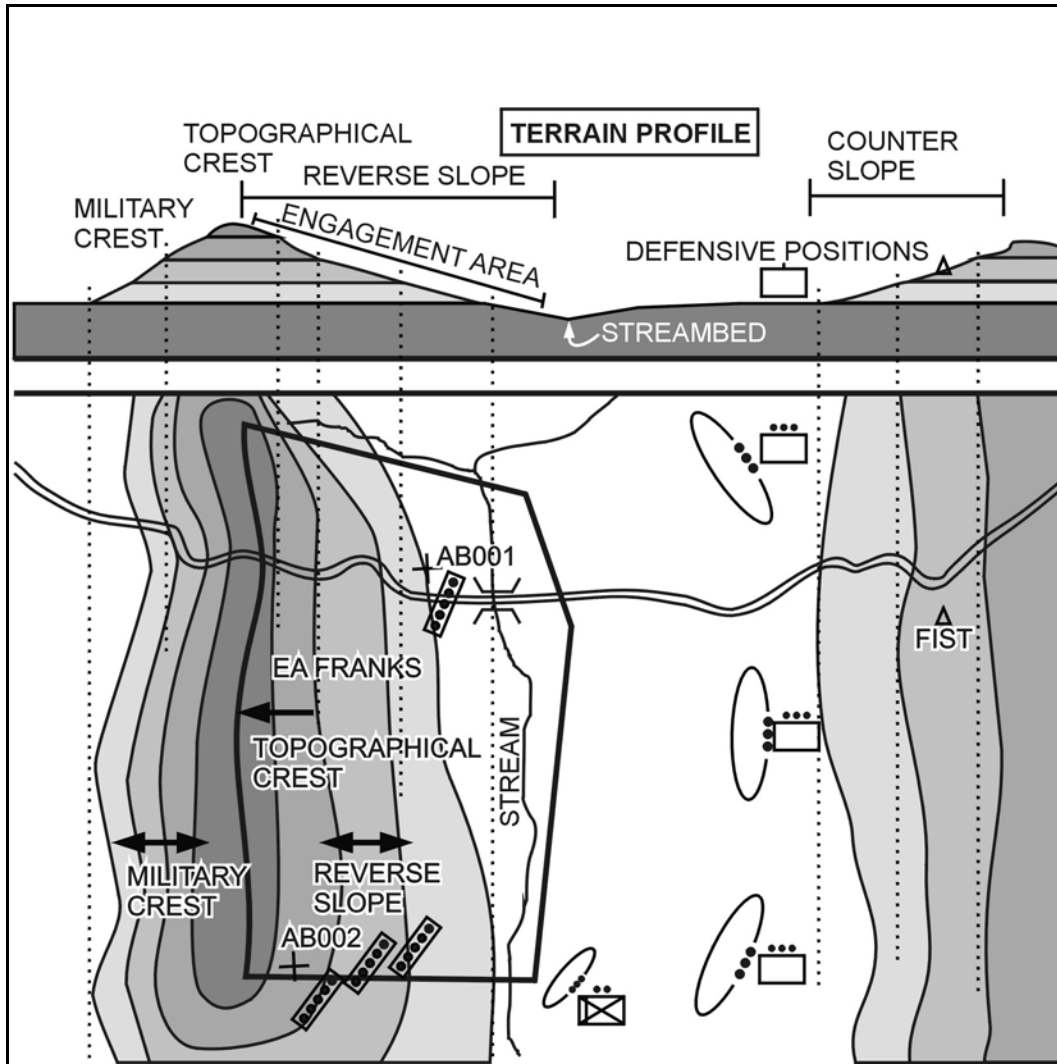

Figure 5-7. Airborne antiarmor company defense on a reverse slope.

(b) The enemy may be deceived and may advance to close contact before he discovers the defensive position. Therefore, the defender may gain the advantage of surprise.

(c) The defender can improve positions, build obstacles, and clear fields of fire without disclosing the location of the positions.

(d) The defender may use dummy positions on the forward slope to deceive the enemy.

(e) Resupply and evacuation (when under attack) may be easier when defending on a reverse slope.

(f) Enemy target acquisition and jamming efforts are degraded. Enemy radar, infrared sights, and thermal viewers cannot detect soldiers masked by a hill. Radios with a hill between them and the enemy are less vulnerable to jamming and direction finders.

(g) Enemy use of close air support and attack helicopters is restricted. Enemy aircraft must attack defensive positions from the flank or from the rear, which makes it easier for friendly air defense weapons to hit them.

(h) A counterattacking unit has more freedom of maneuver since it is masked from the enemy's direct fire.

(2) **Special Considerations.** These considerations may apply when defending on a reverse slope.

(a) Observation of the enemy is more difficult. Soldiers in a reverse slope position can see forward no farther than the crest. This makes it hard to determine exactly where the enemy is as he advances, especially when visibility is poor. OPs must be placed forward of the topographic crest for early warning and long-range observation.

(b) Egress from the position may be more difficult.

(c) Fields of fire are normally short.

(d) Obstacles on the forward slope can be covered only with indirect fire or by units on the flanks of the company unless some weapons systems are initially placed forward.

(e) If the enemy gains the crest, he can assault downhill. This may give him a psychological advantage.

(f) If observation posts are insufficient or improperly placed, the defenders may have to fight an enemy who suddenly appears in strength at close range.

(3) **Feasibility.** A defense on a reverse slope may be effective when--

- The forward slope has little cover and concealment.
- The forward slope is untenable because of enemy fire.
- The forward slope has been lost or not yet gained.
- There are better fields of fire on the reverse slope.
- It adds to the surprise and deception.
- The enemy has more long-range weapons than the defender.

(4) **Plans.** The fundamentals of the defense apply to a defense on a reverse slope.

(a) Forward unit positions should be within 200 to 500 meters of the crest of the defended hill or ridge and sited so they block enemy approaches and exploit existing obstacles. They should permit surprise fire on the crest and on the approaches around the crest. Forward fighting positions should have rear and overhead cover to protect friendly soldiers from fratricide.

(b) Emplace observation posts, including FIST personnel (if available), on the crest or the forward slope of the defended hill. At night, observation posts and patrol units should be increased to prevent infiltration. M2 heavy machine guns may be employed at the observation posts.

(c) Position the unit in depth or reserve where it can provide the most flexibility, support the forward units by fire, protect the flanks and the rear of the higher unit, and, if necessary, counterattack. It may be positioned on the counterslope to the rear of the forward units if that position allows it to fire and hit the enemy when he reaches the crest of the defended hill.

(d) Position the unit command post to the rear where it will not interfere with the supporting units or the employment of the reserve. The commander (or platoon leader) may have an observation post on the forward slope or crest and another on the reverse slope or counterslope. He uses the observation post on the forward slope or crest before the battle starts when he is trying to determine the enemy's intentions. During the fight, he moves to the observation post on the reverse slope or counterslope.

(e) Plan indirect fire well forward of, on, and to the flanks of the forward slope, crest, reverse slope, and counterslope. Plan indirect FPF on the crest of the hill to control the crest and stop assaults.

(f) Reinforce existing obstacles. Protective obstacles on the reverse slope--just down from the crest where it can be covered by fire--can slow the enemy's advance and hold him under friendly fire.

(g) The commander normally plans counterattacks. He plans to drive the enemy off the crest by fire, if possible. He must also be prepared to drive the enemy off by fire and movement

5-15. OTHER DEFENSIVE EMPLOYMENT OPTIONS

The antiarmor company (or platoon) may participate in a defense by operating as a battalion's security force (or part of the security force) and as a battalion's reserve. The SBCT antiarmor company may have a slight variation of these two employment options.

a. **Security Force.** Battalion and brigade security forces normally conduct the tactical tasks screen or guard. Defending battalions deploy security forces beyond the FEBA to provide early warning, to deny enemy observation of the MBA, to assist rearward passage of a covering force, and to deceive and disorganize the enemy. The security force commander places the security force where it can cover enemy avenues of approach into the defensive sector. One or more antiarmor platoons can form part of the battalion's security force. The battalion commander positions the antiarmor company or platoon in areas that offer long-range observation and fields of fire on high-speed enemy avenues of approach. Their thermal sights and mobility make them an efficient asset in these operations. Platoons normally operate under the control of a security force commander. The security force commander may be a rifle company commander; however, in airborne and air assault battalions, the antiarmor company commander may be the security force commander.

(1) **Organization.** The security force is organized into *finders* and *fighters*. Finders are tasked to detect enemy reconnaissance forces as they enter the battalion's security zone. Once they identify enemy targets, finders report the enemy's location and direction of travel to the fighters. The fighters scan for the target to confirm its identification with the finders and engage to destroy it. Antiarmor platoons can participate as finders or fighters. They are a critical asset to the battalion and should not be employed without dismounted infantry security.

(a) The battalion S2 provides the results of his IPB in the form of the disposition, composition, capabilities, and the most probable course of action (MPCOA), with accompanying SITEMP, for the enemy's reconnaissance effort. The results of the terrain analysis, which includes line-of-sight (LOS) information, will be valuable when considering the tactical array or disposition of security forces. Antiarmor units can determine the LOS on their map reconnaissance using a technique described in FM 3-25.26.

(b) Leaders ensure their subordinates receive the appropriate control measures, which include the locations and graphics for the remainder of the security force. All security force elements should have common graphics to ensure a clear understanding of the situation (for example, phase lines, checkpoints, and target reference points to control the

hand-off of targets). If each element in the security force uses different control measures, then the security force effort will be disjointed and ineffective.

(2) **Finders.** The antiarmor platoon uses its optics, PVS-7Bs, thermal sights, and daysights to effectively detect enemy reconnaissance forces. The reconnaissance platoon, rifle platoons, and other ISR assets like the ground surveillance radar (GSR) often serve as finders during security operations.

(a) The platoon leader positions his sections to cover the likely avenues of approach used by enemy reconnaissance elements in accordance with the security force commander's guidance. Units position where they are not decisively engaged during the security fight. The high magnification of the available sights allows antiarmor units to observe avenues of approach from a distance. The finder force usually positions to the front and flanks of the fighter force, although antiarmor units, with their high magnification capability, can function as the finders and can locate behind the fighters. This is an effective employment option of an antiarmor platoon during security operations.

(b) Security force elements observe named areas of interest (NAIs) along the anticipated enemy avenues of approach. Upon detection of enemy targets, the platoon sends reports to the fighters. The location and direction of travel are clarified by using the common control measures of the security force (for example, enemy armored personnel carrier at TRP 2 moving east to TRP 3). Security force elements use their optics equipment and aiming lights to point out targets for the fighters. This is especially useful when the fighters have difficulty detecting the target. The limitations to these techniques are that the enemy may detect the IR signature and take evasive action as well as engage the source. Leaders closely monitor the situation and ensure their units positively identify targets to prevent friendly units from being mistaken for an enemy force.

(3) **Fighters.** An antiarmor platoon can also be an effective member of the fighter force. The TOW, M2, and MK19 allow a platoon to destroy any type of reconnaissance element. The platoon is positioned so that it has good fields of fire and observation of the avenues of approach. The platoon leader may have to designate supplementary and alternate positions if there are more mobility corridors than can be covered from one position.

(a) A weapons mix is selected based on the battalion's IPB, security force commander's guidance, and the platoon leader's own METT-TC analysis. Some major concerns are the type of reconnaissance vehicles expected (armor protection) and the fields of fire available. The TOW may not be an effective weapon system against reconnaissance vehicles in restrictive terrain because of tracking limitations. (See Appendix E for a discussion of TOW employment in restricted terrain.) The M2 and MK19 can destroy most lightly armored reconnaissance vehicles such as BMPs and Boyevaya Razvedyuatel'naya Dozornaya Meshinas (BRDMs) (Russian combat reconnaissance patrol vehicles).

(b) Leaders monitor the situation to ensure they are aware of the locations of the remainder of the security force. They accept target hand over from the finders. They receive target information as to the type, location, and direction of travel. Common control measures clarify the information. Once targets are identified, they are tracked until the desired point of engagement, then destroyed. There is risk of antiarmor systems being lost before the main battle when employing antiarmor elements during security

operations. Using them as fighters further increases the risk of their destruction. When battalions are organized with one antiarmor platoon, using them primarily as finders and secondarily as fighters may be the preferred option. The platoon can detect targets and hand them off to infantryman armed with Javelins and AT4s. The antiarmor platoon engages only if enemy reconnaissance assets bypass the primary fighters.

(3) **Withdrawal.** The security force normally conducts a rearward passage of lines before the conduct of the MBA defense during limited visibility. This requires detailed coordination. The withdrawal route and other control measures are provided to MBA forces before the passage of lines. The security force also can mark itself using IR markers to provide visual identification to the MBA forces. This identification, combined with rehearsals of the rearward passage, will improve night observation devices and reduce the likelihood of fratricide.

b. **Reserve.** The commander may decide to use his antiarmor units as his reserve, specifically when there is more than one mobility corridor the enemy is likely to use, negating the use of one unit battle position. He may also designate his antiarmor units as the reserve during security operations and the mobile defense at the SBCT level. When operating as the reserve, the antiarmor unit performs a variety of missions to include these counterattack missions:

- Block a penetration from an attack by fire position.
- Occupy a battle position.
- Reinforce another unit's position.
- Destroy enemy CS or CSS forces.

The reserve is normally positioned in an assembly area to wait for orders to execute one of several contingencies. The antiarmor company commander (or platoon leader) conducts rehearsals of all his contingency missions. During security operations, he receives the priority of the potential missions to ensure he can rehearse them with his subordinate leaders. Another technique for the company is to have the company XO, with the platoon sergeants, rehearse the potential missions while the company is conducting the security operation. Full-up rehearsals may not be possible.

(1) **Block a Penetration.** Normally, the unit moves to an attack-by-fire position to block the enemy's penetration. The attack by fire is positioned to allow full use of the unit's weapons systems. The company commander (or platoon leader) uses the fire control measures described in Appendix C (Direct Fire Planning and Control) to ensure he can accomplish his purpose.

(2) **Occupy a Battle Position.** When ordered, the company (or platoon) moves to a pre-assigned battle position and executes the assigned mission. The method for building the defense is the same as previously discussed with the major difference being the amount of preparation. The unit may be responsible for several battle positions. If so, it builds and rehearses all of them. The factors of METT-TC determine the amount of preparation completed on each position. The unit keeps the direct fire plan as simple as possible in each engagement area to reduce confusion.

(3) Antiarmor units may receive the mission to be prepared for a combination of the above roles. The brigade (SBCT) or battalion clarifies the priority of each contingency to focus their preparation. The execution of all of these missions may occur during limited visibility. IR markers are used to mark vehicle positions for rapid occupation. Any unit

TRPs emplaced are set up for limited visibility before darkness (for example, heat the TRPs or use IR source markers as TRPs).

(4) ***Reinforce Another Unit's Position.*** The antiarmor unit may be called upon to reinforce a combat-ineffective unit to reestablish the integrity of the defense. This reinforcement is typically not planned. To ensure success, the company commander (or platoon leader) must, if time is available, conduct a reconnaissance of all battle positions in the defense and have a basic understanding of each commander's concept.

5-16. ENGAGEMENT AREA DEVELOPMENT

The engagement area is where the company commander (or platoon leader) intends to destroy an enemy force using the massed fires of all available weapons. The success of any engagement depends on how effectively he can integrate the obstacle plan, the indirect fire plan, the direct fire plan, and the terrain within the engagement area to achieve the unit's tactical purpose. Beginning with evaluation of METT-TC factors, the development process covers these steps:

- Identify all likely enemy avenues of approach.
- Determine likely enemy schemes of maneuver.
- Determine where to kill the enemy.
- Emplace weapons systems.
- Plan and integrate obstacles.
- Plan and integrate indirect fires.
- Rehearse the execution of operations in the engagement area.

The following paragraphs outline planning and preparation procedures an antiarmor company commander may use for each of these steps.

a. **Identify Likely Enemy Avenues of Approach.** The following procedures and considerations, as illustrated in Figure 5-8, page 4-26, apply in identifying the enemy's likely avenues of approach.

(1) Conduct initial reconnaissance. If possible, do this from the enemy's perspective along each avenue of approach into the sector or engagement area.

(2) Identify key and decisive terrain. This includes locations that afford positions of advantage over the enemy as well as natural obstacles and choke points that restrict forward movement.

(3) Determine which avenues will provide cover and concealment for the enemy while allowing him to maintain his tempo.

(4) Evaluate lateral routes adjoining each avenue of approach.

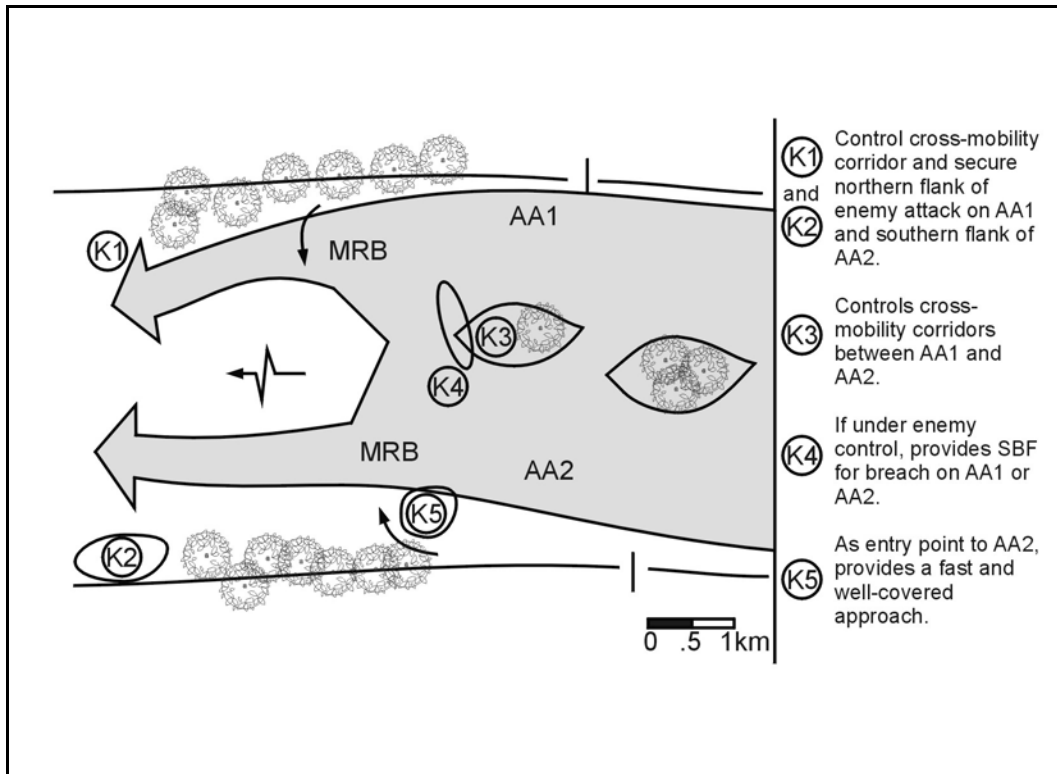

Figure 5-8. Identify all likely enemy avenues of approach.

b. **Determine the Enemy Scheme of Maneuver.** The company commander can use the following procedures and considerations, which are illustrated in Figure 5-9, in determining the enemy's scheme of maneuver.

(1) Determine how the enemy will structure the attack. In what formation will he attack? How will he sequence his forces?

(2) Determine how the enemy will use his reconnaissance assets. Will he attempt to infiltrate friendly positions?

(3) Determine where and when the enemy will change formations and establish support-by-fire positions.

(4) Determine where, when, and how the enemy will conduct his assault and breaching operations.

(5) Determine where and when the enemy will commit follow-on forces.

(6) Determine the enemy's expected rates of movement.

(7) Assess the effects of the enemy's combat multipliers.

(8) Determine what reactions the enemy is likely to have in response to projected friendly actions.

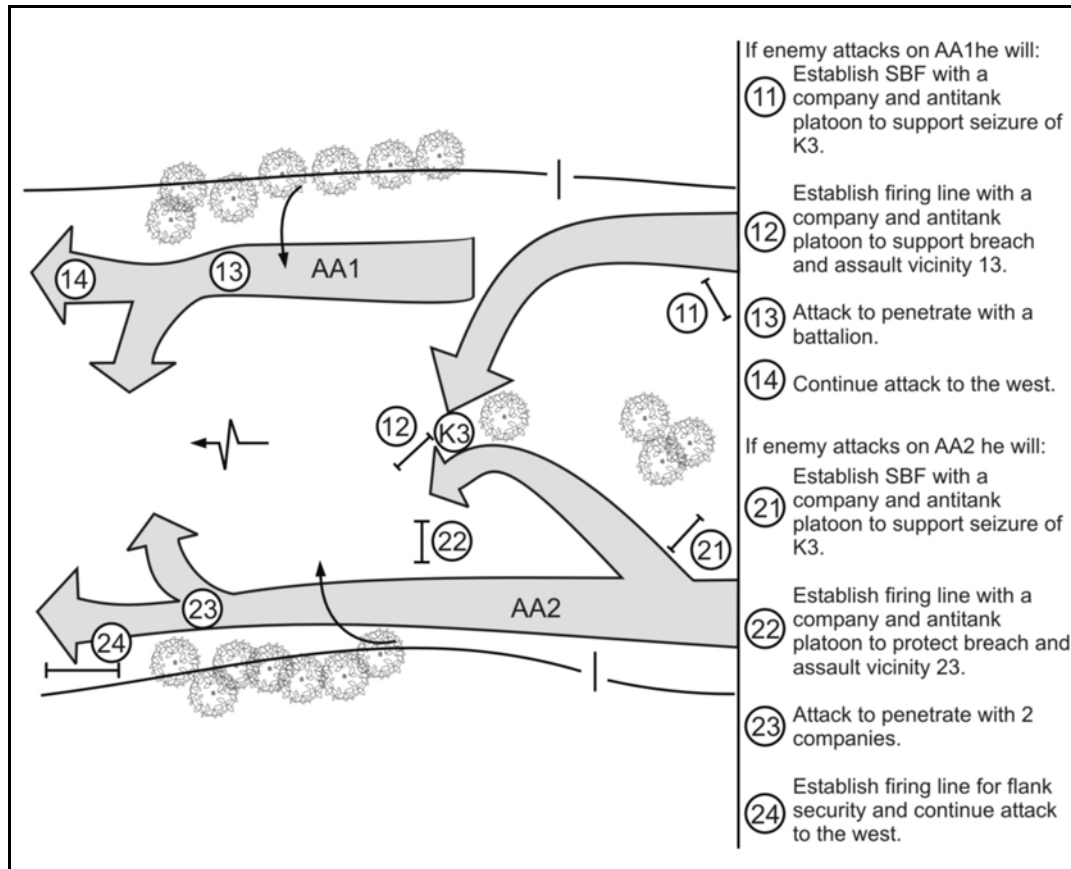

Figure 5-9. Determine the enemy's scheme of maneuver.

c. **Determine Where to Kill the Enemy.** The following steps (Figure 5-10, page 5-28) apply in identifying and marking where the higher unit and company will engage the enemy.

- (1) Identify TRPs that match the enemy's scheme of maneuver, allowing the company to identify where it will engage enemy forces through the depth of the sector.
- (2) Identify and record the exact location of each TRP.
- (3) Determine how many weapons systems, by type, must focus fires on each TRP to achieve the desired effects.
- (4) Determine which platoons will mass fires on each TRP.
- (5) Establish engagement areas around TRPs.
- (6) Develop the direct fire planning measures necessary to focus fires at each TRP.

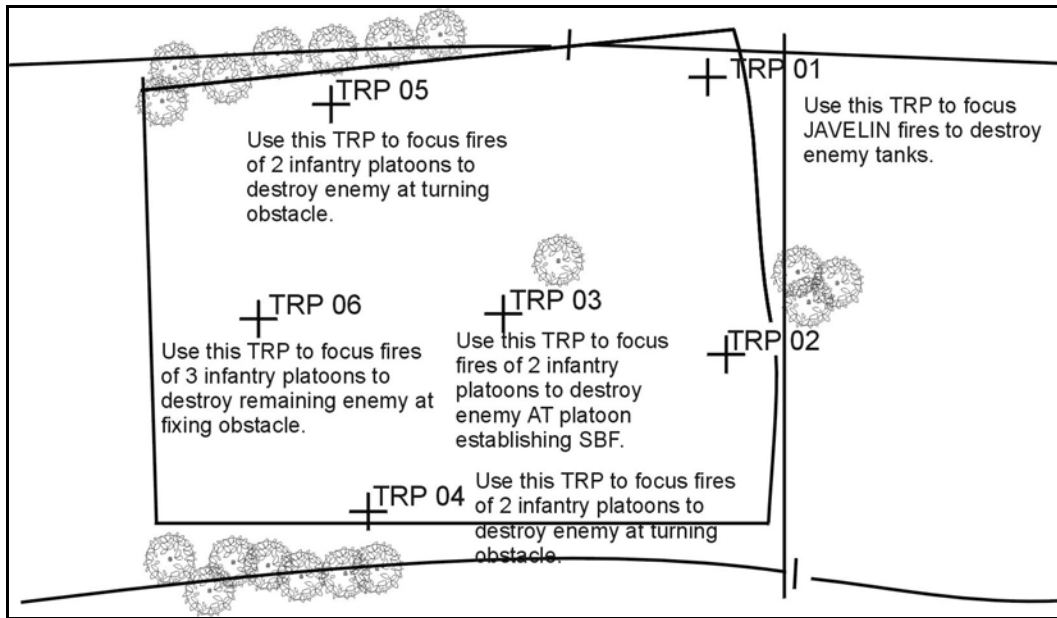

Figure 5-10. Determine where to kill the enemy.

NOTE: In marking TRPs, use thermal sights to ensure visibility at the appropriate range under varying conditions, including daylight and limited visibility (darkness, smoke, dust, or other obscurants).

d. Emplace Weapons Systems. The following steps apply in selecting and improving battle positions and emplacing the company's vehicles (HMMWV or ICV) and crew-served weapons systems (Figure 5-11).

(1) Select tentative platoon battle positions. (When possible, select these while moving in the engagement area. Using the enemy's perspective enables the commander to assess survivability of the positions.)

(2) Conduct a leader's reconnaissance of the tentative battle positions.

(3) Drive the engagement area to confirm that selected positions are tactically advantageous.

(4) Confirm and mark the selected battle positions.

(5) Ensure that battle positions do not conflict with those of adjacent units and that they are effectively tied in with adjacent positions.

(6) Select primary, alternate, and supplementary fighting positions to achieve the desired effect for each TRP in the engagement area.

(7) Ensure that platoon leaders, platoon sergeants, section leaders, and squad leaders position weapons systems to effectively cover each TRP with the required number of weapons systems (by type) and platoons.

(8) Site and mark vehicle positions in accordance with unit SOP so engineers can dig in the positions while section leaders supervise.

(9) Proof all vehicle positions before engineer assets depart.

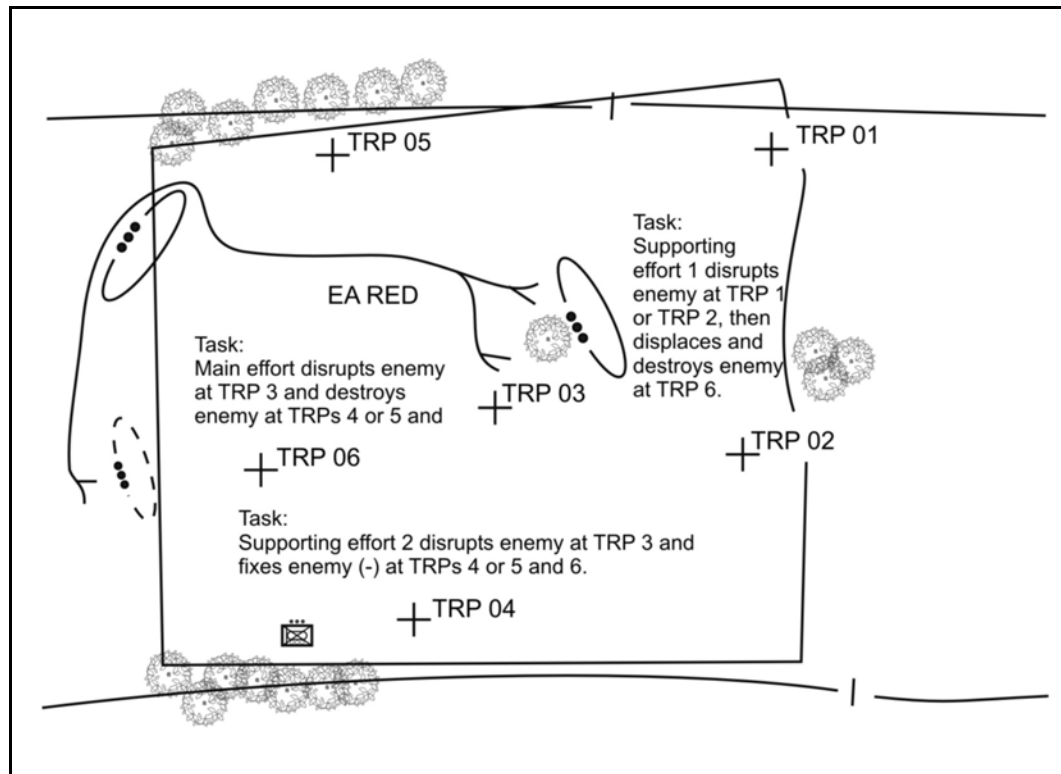

Figure 5-11. Emplace weapons systems.

e. **Plan and Integrate Obstacles.** The following steps apply in planning and integrating obstacles in the antiarmor company defense (Figure 5-12, page 5-30).

- (1) Understand obstacle group intent.
- (2) Coordinate with the engineers.
- (3) Site and mark individual obstacle locations.
- (4) Refine direct and indirect fire control measures.
- (5) Identify lanes and gaps.
- (6) Report obstacle locations and gaps to higher headquarters.

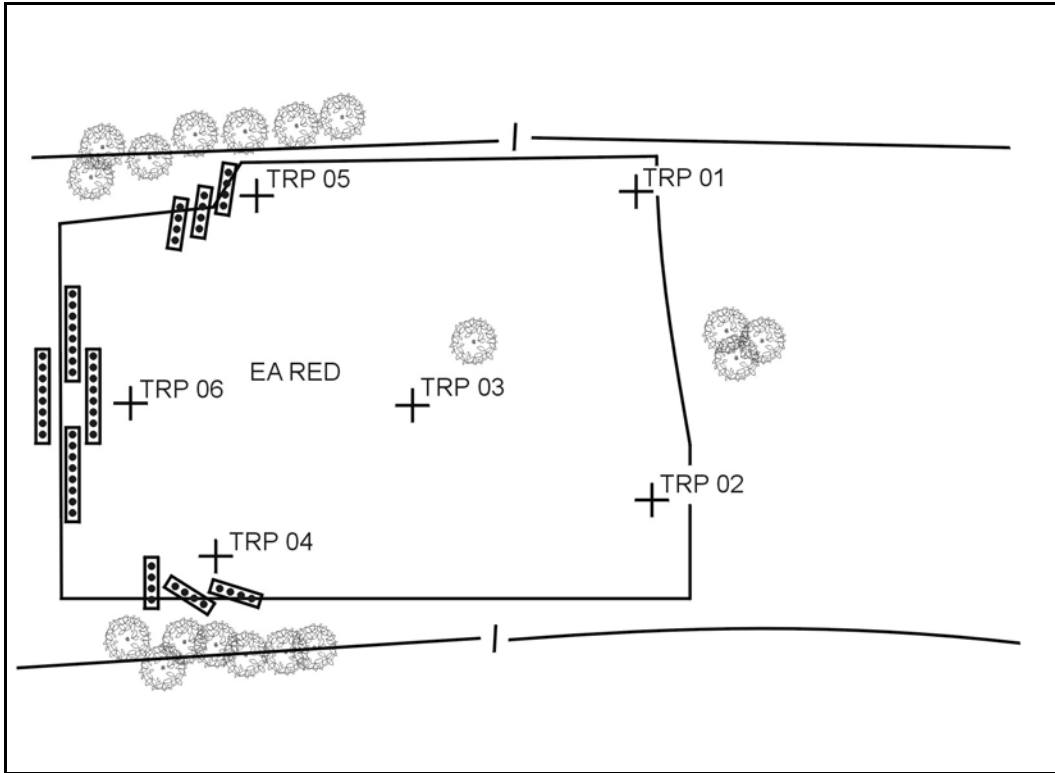

Figure 5-12. Plan and Integrate obstacles.

f. **Plan and Integrate Indirect Fires.** The following steps apply in planning and integrating indirect fires (Figure 5-13).

- (1) Determine the purpose of fires and the essential fire support task (EFST) that supports it.
- (2) Determine where that purpose can best be achieved.
- (3) Establish the observation plan, with redundancy for each target. Observers include the FIST (if available) as well as members of maneuver elements with fire support responsibilities (such as section leaders).
- (4) Establish triggers.
- (5) Obtain accurate target locations using lazing devices.
- (6) Refine target locations to ensure coverage of obstacles.
- (7) Adjust artillery and mortar targets.
- (8) Plan FPFs.
- (9) Request critical friendly zones (CFZ) for protection of maneuver elements and no-fire areas (NFAs) for protection of observation posts and forward positions.

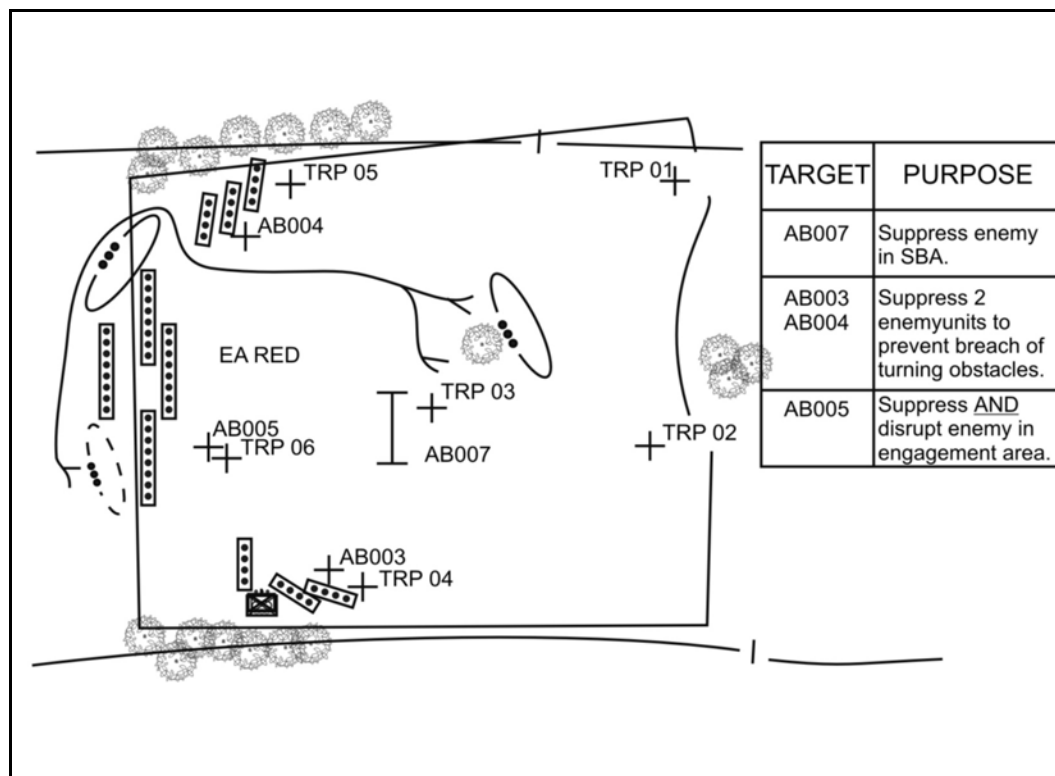

Figure 5-13. Integrate direct and indirect fires.

g. **Conduct an Engagement Area Rehearsal.** The purpose of this rehearsal is to ensure every leader and soldier understands the plan and all elements are prepared to cover their assigned areas with direct and indirect fires. Although the antiarmor company commander has several options, the most common and most effective type of rehearsal is replicating the threat. One technique for the mounted rehearsal in the defense is to have the company trains, under the control of the company XO, move through the engagement area to depict the enemy force while the commander and subordinate platoons rehearse the battle from the company battle position. The rehearsal should cover these actions:

- Rearward passage of security forces (as required).
- Closure of lanes (as required).
- Movement from the hide position to the battle position.
- Use of fire commands, triggers, and maximum engagement lines (MELs) to initiate direct and indirect fires.
- Shifting of fires to refocus and redistribute fire effects.
- Emplacement of scatterable mine system.
- Preparation and transmission of critical reports (FM or FBCB2)
- Assessment of the effects of enemy weapons systems.
- Displacement to alternate, supplementary, or successive battle positions.
- Cross-leveling or resupply of Class V.
- Evacuation of casualties.

NOTE: The company commander should coordinate the rehearsal with the higher headquarters to ensure other units' rehearsals are not planned for the same

time or location. Coordination leads to more efficient use of planning and preparation time for all units. It also eliminates the danger of misidentification of friendly forces in the rehearsal area, which could result in fratricide.

5-17. PRIORITY OF WORK

This is a set method of controlling the preparation and conduct of a defense. SOP should describe priority of work to include individual duties. A commander changes priorities based on the situation. The leaders in the unit all should have a specific priority of work for their duty position.

a. Although listed in sequence, several tasks may be performed at the same time. An example priority of work sequence is listed below:

- Post security (air guards, observation posts, patrols, chemical agent alarms, assign observation sectors to scan).
- Plan and emplace direct fire control measures, TRPs (all visual spectra), trigger lines
- Plan indirect fires and ensure their effects do not obstruct the gunner's view of the engagement area.
- Prepare primary positions; leaders prioritize their subordinate units for engineer digging assets

NOTE: Marking positions during the leader's reconnaissance allows digging to occur prior to the entire unit occupying the position.

- Select and prepare alternate positions. If engineer assets do not have the blade time to dig positions, give careful consideration to existing cover.
- Designate supplementary positions. These positions may not be allocated engineer effort, so the same guidance provided for alternate positions applies.
- Designate hide positions. These are positioned where they are concealed from enemy reconnaissance assets and preferably safe from the impact of artillery fires on primary positions.
- Dig primary fighting positions for anticipated fighting conditions (daylight or limited visibility). Supervision of engineer assets is invaluable to ensure positions are dug to standard and to maximize the precious available time.
- Achieve mutual support or concentration of fires.
- Coordinate with adjacent units to ensure dead space does not exist.
- Emplace tactical obstacles.
- Clear fields of fire.
- Establish coordination or contact points.
- Emplace protective obstacles.
- Emplace wire for communications.
- Reposition (cache) and dig in ammunition.
- Prepare range cards or platoon and company defensive sector sketches.
- Mark and prepare routes.
- Rehearse movement from hide into the position.
- Rehearse casualty evacuation.

- Rehearse actions during limited visibility.
 - Use briefbacks to ensure the mission is understood.
- b. Routine priorities for various duty positions are as follows:
- (1) ***Antiarmor Company Commander***. Many of these duties can be delegated to subordinates, but the commander (or antiarmor platoon leader in a light infantry battalion) must ensure they are done.
- (a) Establish local security. Set up observation posts if not already done and establish company perimeter.
- (b) Conduct a leader's reconnaissance with the subordinate leaders and selected personnel. Confirm or deny significant deductions or assumptions from the mission analysis. Designate primary, alternate, and supplementary positions for subordinate platoons, sections, and other supporting elements. Require subordinate units to conduct coordination. Designate engagement area, designate and integrate obstacles, designate the general command post location, and position weapons systems.
- (c) Check the command post and brief the 1SG or XO on the situation and logistics requirements.
- (d) Upon receipt of the platoon sector sketches, make two copies of a defensive sector sketch and a fire plan. Retain one copy and forward the other copy or digitally transmit (if equipped) a copy of the sector sketch to higher headquarters. The antiarmor platoon leader from a light infantry battalion will forward his platoon sector sketch directly to the battalion headquarters or to the company to which he is attached (refer to paragraph 5-18).
- (e) Confirm the positions before digging starts. Coordinate with the adjacent units.
- (f) Check with the higher commander for any changes or updates in the orders.
- (g) Finish the security, deception, counterattack, and obstacle plans.
- (h) Walk the positions after they are dug. Confirm clear fields of fire and complete coverage of the sector of fire of all weapons systems. Look at the defensive plan from an enemy point of view, both conceptually and physically.
- (i) Check dissemination of information, interlocking fires, dead space, and security. Correct identified deficiencies immediately.
- (j) Report refined obstacle locations to the higher headquarters.
- (2) ***First Sergeant and Executive Officer***. One of them must--
- (a) Establish the company command post. Ensure applicable communications links are established with the higher headquarters and the platoons, sections, and attached elements.
- (b) Establish casualty collection points, company logistic release points, and EPW collection points.
- (c) Brief platoon sergeants on the company command post location, logistics plan, and routes between positions.
- (d) Assist the company commander with the sector sketch.
- (e) Request and allocate barrier material, rations, water, and ammunition.
- (f) Walk the positions with the company commander. Start supervising emplacement of the platoons and sections, and check range cards and sector sketches.
- (g) Establish routine security or alert plan, radio watch, and rest plan. Brief the company commander.
- (h) Supervise continuously and assist the commander with other duties as assigned.

(3) **Fire Support Officer.** A fire support officer leads the fire support team in the SBCT antiarmor company. Airborne and air assault antiarmor companies may have an FSO attached. The FSO must--

(a) Assist the company commander in planning the indirect fires to support the defense.

(b) Advise the commander on the current status of all firing units and on the use of smoke or illumination.

(c) Coordinate with the higher headquarters FSO, firing units, and platoon leaders to ensure the indirect fire plan is synchronized with direct fires and obstacles and is fully understood.

(d) Ensure the indirect fire plan is rehearsed and understood by all.

(e) Ensure all FPFs are adjusted in as soon as possible.

(f) Develop observation plan as part of the fire support plan.

(g) Coordinate and rehearse any repositioning of observers within the company area of operation to ensure they can observe targets or areas of responsibility.

(h) Develop and advise the commander of necessary triggers.

(i) Report battlefield intelligence.

(j) Ensure redundancy in communications.

5-18. SECTOR SKETCHES

Antiarmor leaders prepare sector sketches based on their defensive plan. These sector sketches are based on range cards prepared for all crew-served weapons systems (TOW, M2, and MK19) and individual weapons. The sector sketch allows the higher headquarters to determine the effectiveness of the direct fire plan. If necessary, the higher commander makes adjustments to the sectors and or position of his subordinates. Sector sketches also are useful for units occupying previously prepared defenses (relief in place).

a. **Section Sector Sketch.** Each section leader prepares a sector sketch to visually depict his section's fire plan. This information is found on the range card for the two squads. The section leader makes two copies of the sketch, keeping one and forwarding the other to his platoon leader. The sector sketch should provide the following information:

- Prominent terrain features in the sector of fire and the ranges to them.
- Each antiarmor squad's primary and secondary sectors of fire.
- MELs.
- TRPs.
- Dead space.
- Phase lines (triggers) where firing should begin or where the section is to disengage.
- Obstacles and indirect-fire targets.
- Distance and direction to all dead space and TRPs.

b. **Platoon Sector Sketches.** The platoon leader inspects the section sector sketches. He uses these sector sketches to prepare his platoon sector sketch. He also makes two copies, keeping one and forwarding the other copy or digitally transmitting (if equipped) a copy of the sector sketch to his commander or higher headquarters. Using the section sector sketches, the platoon leader can prepare a platoon engagement matrix (Table 5-3).

This matrix aids the platoon leader by detailing what TRPs each section can observe by position (primary, alternate, and supplementary).

POSITION	TRP 001	TRP 002	TRP 003	TRP 004	TRP 005
SECTION 1: PRIMARY	X	X	X		
ALTERNATE	X	X			
SUPPLEMENTARY			X	X	X
SECTION 2: PRIMARY		X	X		X
ALTERNATE			X		X
SUPPLEMENTARY				X	

Table 5-3. Platoon engagement matrix.

5-19. ADJACENT UNIT COORDINATION

The ultimate goal of adjacent unit coordination is to ensure unity of effort in the accomplishment of the battalion and brigade (or SBCT) mission. Items that adjacent units must coordinate include, but are not limited to, the following:

- Unit positions, including locations of command and control nodes.
- Locations of observation posts and patrols.
- Overlapping fires (to ensure that direct fire responsibility is clearly defined).
- Target reference points.
- Primary, alternate, and supplementary battle positions.
- Indirect fire and automated net control device (ANCD) information.
- Obstacles (location, orientation, and type).
- Air defense considerations, if applicable.
- Routes to be used during occupation and repositioning.
- CSS considerations.

CHAPTER 6

URBAN OPERATIONS

The first and most fundamental lesson learned from recent operations in built-up areas is the value of the fully integrated combined-arms team. There is no denying the value of infantry, armored, and antiarmor forces during urban combat. Urban operations (UO) never should be considered a purely infantry task. Infantry units operating alone suffer from critical shortcomings that can be overcome only by appropriate task organization with antiarmor capability to achieve a combined-arms effect. These forces must be supported by closely integrated antiarmor, armor, aviation, indirect fire support, communications, and logistical elements. Across the spectrum of operations in urban areas, the combined-arms team will produce the best results. Commanders at all levels must determine the composition of these combined-arms teams based on a careful METT-TC analysis.

Section I. GENERAL PLANNING CONSIDERATIONS

This section highlights the basic UO planning considerations for commanders of SBCT antiarmor companies and airborne and air assault infantry battalions *antiarmor* companies and, in the case of light infantry battalions, the antiarmor platoon leaders.

6-1. EMPLOYMENT CONSIDERATIONS FOR COMPANY-SIZE COMBINED-ARMS TEAMS

Because of the decentralized nature of urban combat and the need for a high number of troops to conduct operations in dense, complex terrain, infantrymen will always represent the bulk of forces. At the tactical level, infantry forces have disadvantages that can be overcome by mechanized infantry, antiarmor, or armor units. Conversely, vehicles face problems in the confines of urban areas that place them at a severe disadvantage when operating alone, unsupported by infantry. Only by working together can these forces accomplish their missions with minimal casualties while avoiding unnecessary collateral damage. (See Appendix E, TOW Employment in Restrictive Terrain.)

a. **Infantry Strengths.** The infantry has the following strengths in an urban environment.

(1) Infantry small-arms fire within a building can eliminate resistance without seriously damaging the structure.

(2) Infantrymen can move stealthily into position without alerting the enemy. Infantrymen can move over or around most urban terrain regardless of the amount of damage to buildings.

(3) Infantrymen have excellent all-round vision and can engage targets with small-arms fire under almost all conditions.

b. **Antiarmor System Strengths.** Antiarmor weapon systems in an urban environment have the following strengths.

(1) The thermal sights on the antiarmor weapon systems can detect enemy activity through darkness and most smoke.

(2) The precision direct fires of TOW and the destructive effects of the M2 and MK19 provide excellent support to infantry in an urban environment.

(3) Mounted patrols in all types of antiarmor vehicles (HMMWV or ICV) can monitor large areas of a city while making their presence known to the entire populace, both friendly and unfriendly.

(4) The mobile firepower of antiarmor vehicles can add security to resupply convoys.

(5) Antiarmor vehicles can resupply units quickly and with more ammunition than resupply by foot.

c. **Infantry Limitations.** Infantry forces have the following limitations in an urban environment.

(1) They lack heavy supporting firepower, protection, and long-range mobility.

(2) Exposed infantry forces are subject to taking a high number of casualties.

(3) Infantry forces are more subject to fratricide-related casualties from friendly direct and indirect fire.

d. **Antiarmor System Limitations.** Antiarmor forces have the following limitations in an urban environment.

(1) Antiarmor squads can be blinded easily by smoke or dust in the urban environment.

(2) If isolated or unsupported by infantry, antiarmor vehicles are vulnerable to enemy machine guns and light or medium antiarmor weapons.

(3) Antiarmor vehicle gunners cannot easily identify enemy targets in the confusing urban environment.

(4) Improvised barricades, narrow streets and alleyways, or large amounts of rubble can block antiarmor vehicles.

(5) Direct fires from antiarmor weapons systems (TOW, M2, and MK19) may cause unwanted collateral damage and can destabilize basic structures.

6-2. EMPLOYMENT OF ANTIARMOR VEHICLES

In most tactical situations antiarmor vehicles can be used effectively if they mass their fires. Antiarmor units operating in company and platoon strength combine mobility, firepower, and protection to seize the initiative from the enemy and aid friendly success. However, urban combat is often so decentralized and avenues of approach for vehicles so canalized that the urban situation requires that fewer antiarmor vehicles be employed over broader areas. The decision to disperse rather than concentrate antiarmor vehicles in a specific area should be made only after a careful consideration of the factors of METT-TC and the anticipated operations in the near future. Decentralized antiarmor support greatly increases a small infantry unit's combat power; however, dispersed antiarmor elements in UO cannot be easily and quickly massed to achieve an overwhelming effect on the enemy.

a. **Employment.** Antiarmor units can support infantry during UO by--

- Isolating objectives with direct fire (TOW, M2, and MK19) to prevent enemy withdrawal, reinforcement, or counterattack.
- Assisting infantry entering into buildings when enemy fire, debris, or obstacles block doorways.
- Securing portions of an objective by covering armored or mechanized avenues of approach.

- Attacking appropriate targets designated by infantry units.
- Establishing roadblocks or checkpoints.

b. **Task Organization at Brigade (SBCT) or Battalion Level.** The brigade (SBCT) and the airborne and air assault infantry battalion have an organic antiarmor company, and the light infantry battalion has an organic antiarmor platoon. There are three basic techniques of task-organizing the antiarmor for UO.

(1) ***Antiarmor Company (or Platoon) Retained under SBCT or Infantry Battalion Control.*** In this technique the antiarmor company commander (or platoon leader) is responsible for maneuvering his vehicles IAW the commander's intent. With this task organization, likely missions for the antiarmor unit are to support by fire or to overwatch movement of the infantry. This task organization poses the most difficulty in maneuvering the antiarmor unit with the dismounted infantry. However, it provides greater flexibility to the commander in supporting the infantry during the fight. The SBCT may also place the antiarmor company or a platoon under operational control (OPCON) of an infantry battalion or to the reconnaissance, surveillance, and target acquisition (RSTA) squadron.

(2) ***Antiarmor Platoon(s) under Each Infantry Company.*** The antiarmor platoons are placed under OPCON of an infantry company. With this technique the maneuver infantry companies have an antiarmor platoon available to support the UO fight and to deploy at the critical place and time. This task organization still allows for support to the infantry while keeping additional support options available for the company commander to employ. The light infantry battalion may OPCON the antiarmor platoon to a single infantry company for much the same reason as above. The battalion may also OPCON the antiarmor sections to the infantry companies.

(3) ***Individual Antiarmor Squads or Sections under Infantry Platoon Control.*** In this technique an antiarmor squad or section may be under the OPCON of an infantry or reconnaissance platoon. The purpose of this type of task organization (based on a detailed analysis of the factors of METT-TC) is to provide selected platoons with increased direct fire in an urban area. Leaders must ensure that the platoon secures the antiarmor squad or section at all times.

(4) ***Selection of a Technique.*** None of the techniques described above are inherently better than another. The task organization must be tailored to accomplish the mission. Regardless of the technique selected, the following guidelines apply:

- Antiarmor sections may operate in support of infantry. It is preferable, however, for antiarmor units to support each other.
- If using antiarmor vehicles (ICVs or HMMWVs) to support infantry squads and fire teams moving from building to building as part of the maneuver plan, the leader of the forward infantry element must control the movement of these antiarmor vehicles.
- When controlling an antiarmor platoon or section, an infantry company commander (or antiarmor company commander) should move forward to a position where he can personally maneuver it effectively in support of the infantry.
- A task organization should not exceed the leader's span of control (two to five subordinate units). If a company commander intends to personally control the

antiarmor unit, then he must not task-organize it to one of his infantry platoons.

- Antiarmor sections or squads need infantry support when the two elements are working together. Do not leave vehicles (ICVs or HMMWVs) alone. These sections or squads are ill prepared to provide their own security during UO. Individual vehicles are extremely vulnerable to dismounted attack when operating in a complex urban environment.

c. **Mutual Support.** Infantry and antiarmor forces work together to bring the maximum combat power available to bear on the enemy. Infantry forces provide the eyes and ears, locating and identifying targets for the antiarmor units to engage. Infantry and antiarmor forces move along covered and concealed routes to assault enemy elements. Infantry forces provide protection from enemy infantry while antiarmor forces provide supporting direct fires (TOW, M2, and MK19) against enemy fortifications and vehicles.

d. **Movement.** Infantry elements normally lead the movement through built-up areas. The antiarmor unit follows closely behind and provides close direct fire support. If the infantry discovers an enemy fortification or vehicle, the antiarmor unit responds immediately with direct fire to destroy, fix, or suppress the enemy, allowing the infantry unit to develop the situation. After allowing sufficient time to develop the situation or conduct short-range reconnaissance, the infantry leader directs the antiarmor unit to move, if necessary, and identifies specific targets to engage.

e. **Coordination.** Coordination between antiarmor and infantry leaders must be close and continuous. The antiarmor vehicle commander (platoon leader, section leader, or squad leader) may need to dismount the vehicle and move, accompanied by the infantry leader, to a position where he can see the route or target better. All involved must understand the signals for initiating, shifting, lifting, or ceasing direct fires. The greatest barrier to close coordination and command and control in UO is the intense noise and complexity of situations. Verbal commands must be backed up by simple, nonverbal signals.

f. **Communications.** Antiarmor leaders must maintain communications with the infantry commander. Individual antiarmor squads and infantrymen communicate with one another using one or more of the following techniques.

(1) **Visual Signals.** Visual signals, either prescribed by an SOP or coordinated during linkup, can facilitate some simple communications.

(2) **FM Radios.** FM radios provide a reliable means of communications between infantry and close supporting antiarmor units. These radios allow the infantry to use terrain more effectively to provide close-in protection for the antiarmor unit. Infantrymen can observe enemy elements while limiting exposure to enemy fires directed against the antiarmor unit. Signal operating instructions (SOI) information can be used between the antiarmor unit and the infantry unit headquarters. This is a fast and reliable method of communications that does not require additional assets. However, some urban environments can severely degrade FM radio communications over long distances or between forces that are inside and outside buildings. All leaders (antiarmor and infantry) must take this possibility into careful consideration during their thorough analyses of the factors of METT-TC.

NOTE: The infantry company commander relies on the radio to help control the battle. It is essential that platoon leaders and radiotelephone operators (RATELOs) be well trained in sending reports. Timely, accurate, and complete reporting from the subordinate elements to the commander is critical for mission success.

(3) **External Phone (SBCT only).** All antiarmor ICVs have external phones that aid in the communication between the antiarmor squad and the infantry.

g. **Smoke.** The use of smoke must be carefully coordinated. Although antiarmor weapon system sights can see through most obscurants, controlling antiarmor and infantry forces becomes significantly more difficult when these forces are enveloped in dense smoke clouds.

h. **Direct Fire Support.** Antiarmor weapon systems are valuable tools for helping assaulting forces isolate the objective area and secure a foothold. As the infantry force then moves to clear the built-up area, the antiarmor unit remains in its initial support-by-fire position. When possible, the antiarmor unit should move to a subsequent position where its direct fires can prevent enemy armor or mechanized reinforcement from attacking the objective and can engage those enemy forces withdrawing from the objective. At this time, the antiarmor unit must be very alert. Because of the nonlinear nature of UO, enemy forces may move to the rear or flanks of the now-isolated antiarmor vehicles and destroy them. If a small element of infantry cannot be spared to support the antiarmor unit, then vehicles (HMMWV or ICV) should move to positions of cover and concealment and mutual support. Antiarmor soldiers should be alert, especially for enemy infantry approaching from above, from the rear, or from the flanks.

i. **Other Considerations.** The following considerations also apply during UO.

(1) Identify available terrain during planning that will support antiarmor vehicle cross-country movement. While the rate of march may be slower, security may be significantly enhanced.

(2) Involve antiarmor leaders in the mission analysis. Their expertise will hasten the understanding of what antiarmor units can and cannot do and will aid the infantry commander in making the best employment decision.

(3) Urban operations are resource intensive. Antiarmor vehicles can carry ammunition, water, and other supplies to support the urban fight.

(4) Commanders must specifically allocate time in the planning process for precombat inspections (PCIs) and precombat checks (PCCs) of the antiarmor unit (for example, the vehicles and required weapon systems).

(5) Conduct a rehearsal at the level where the antiarmor units are task-organized. Try to replicate conditions for mission execution during rehearsals (for example, day, limited visibility, civilians on the battlefield, host nation support, and ROE). Include the following:

- Graphic and fire control measures.
- Direct fire plans.
- Communications.
- Breach drills.
- Techniques for employing antiarmor vehicles and the infantry.

(6) To minimize casualties when moving outside or between buildings--

- Cover all possible threat locations with either observation or direct fire.
- Use smoke to set a screen to block enemy observation of friendly movement for those areas not possible to cover with observation or direct fire.
- Move antiarmor units forward to support infantry movement. Position the antiarmor units before the infantry continues moving.
- Preplan positions if possible, but devise a marking system and communication signals to designate “situation-dependent” positions to help maintain momentum. (For example, “The VS-17 panel on Building 2 means move to SBF 3.”)
- Antiarmor vehicles must move at the infantry’s rate of movement.

(7) Use simple, clearly understood graphic control measures. The following are particularly useful during UO (Figure 6-1):

- Phase lines.
- Number and lettering systems for buildings.
- Tentative support-by-fire positions.
- No-fire areas.

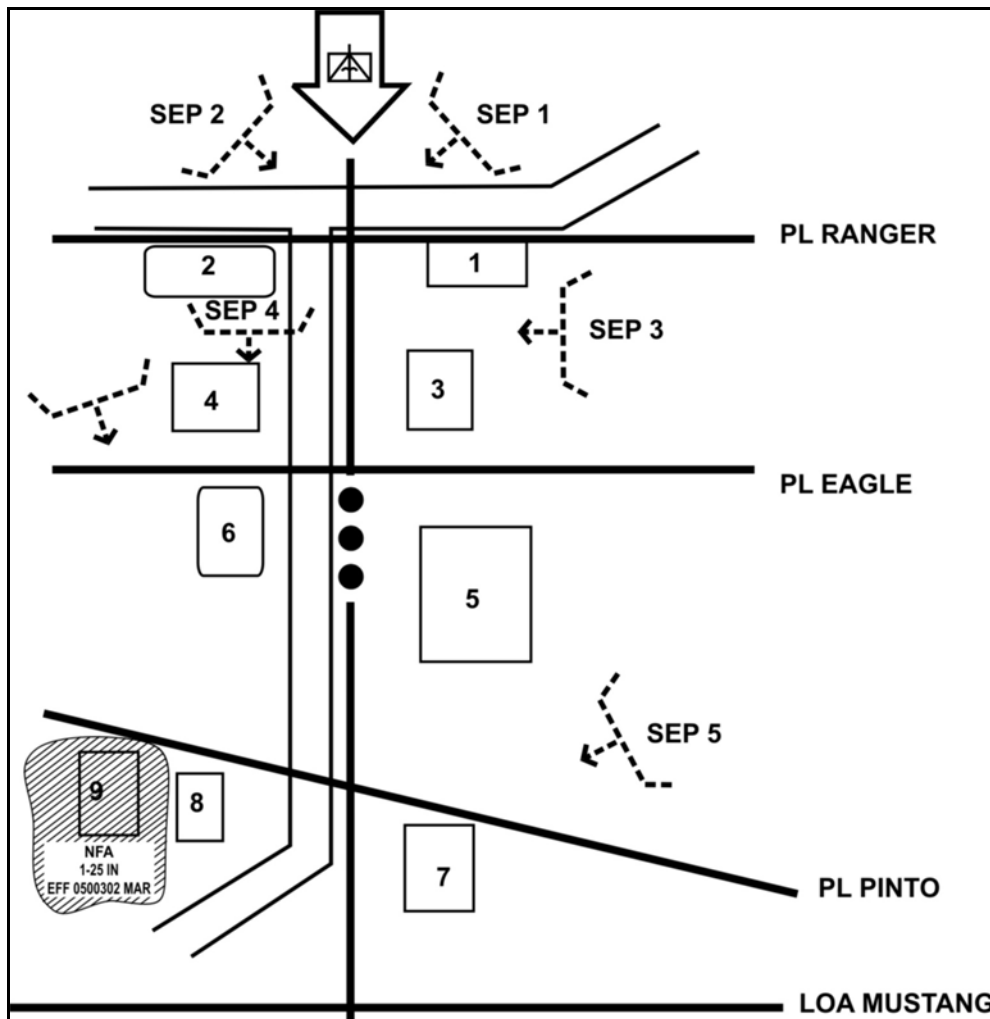

Figure 6-1. Graphic control measures.

Section II. OFFENSE

Offensive operations in urban areas are based on offensive doctrine modified to conform to the urban terrain. Urban combat imposes a number of demands that are different from ordinary field conditions, such as problems with troop requirements, maneuver, and use of equipment. As with all offensive operations, the antiarmor company commander (or platoon leader in the case of the light battalion) must retain his ability to support the infantry commander's intent on how he intends to fix (or suppress) and maneuver against enemy positions.

6-3. GENERAL OFFENSIVE CONSIDERATIONS

Combat operations in a built-up area have a slower tempo than operations in open terrain. Unlike in open terrain, infantry companies cannot maneuver platoons quickly. Due to the close environment and the restricted ability to use all available weapons systems, synchronization of all assets is one of the infantry commander's (or antiarmor leader's) main challenges. Missions in UO are more methodical. Antiarmor units normally conduct missions as part of a higher unit's operation, but they must be prepared to operate independently with infantry providing a degree of security. An antiarmor company also must be prepared to conduct different but mutually supporting missions simultaneously, such as establish a checkpoint and an observation point at the same time.

a. **Troop Requirements.** The nature of combat in built-up areas requires more troops than are normally needed in other combat situations. This is directly related to the effects of terrain and to the numerous tasks required: clear buildings, provide security, control civilians, and evacuate casualties (the probability of casualties is greater in UO).

(1) Additional forces may be needed to control civilians in the built-up area. These forces must protect civilians, provide first aid, and prevent them from interfering with the tactical plan.

(2) Fighting in a built-up area normally results in a greater number of friendly casualties. The ability to see the enemy is fleeting and confined to very short ranges compared to combat in unrestricted or restricted terrain. Fratricide can become a serious problem and must be addressed in detail (refer to Appendix B). Leaders must plan for CASEVAC and designate subordinate units to conduct this task.

b. **Maneuver.** Unlike in unrestricted terrain, the complex nature of the urban environment makes it difficult for antiarmor leaders to maneuver their elements and any attachments quickly. Supporting infantry units as they clear buildings and looking for ambushes, snipers, and booby traps degrades the ability of antiarmor leaders to maneuver their subordinate elements. The urban environment degrades the effects of many of the antiarmor weapon systems. It also makes synchronizing combat power a challenge. Offensive operations must be planned in detail, with subordinate antiarmor elements given specific instructions and on-order missions.

c. **Limitations.** When infantry commanders are attacking a built-up area, leaders must recognize some important limitations in the use of available assets.

(1) Normally, the use of indirect fires, especially field artillery, is much more restricted in built-up areas than in open terrain. Commanders must consider the effects of the indirect fire on the urban area and on civilians. This is especially true when extremely restrictive ROE are in effect. When indirect fires are authorized, they must be fired in greater mass to achieve the desired effect.

(2) Rubbling caused by indirect fires adversely affects a unit's ability to maneuver during the attack and may mask the direct-fire weapon systems available to a unit.

(3) Commanders and leaders must consider the effect that city lights, fires, and background illumination have on night vision devices. These elements may limit the effectiveness of NVDs and even make thermal imagery identification difficult.

(4) Communications equipment may not function to its maximum effectiveness because of dense building construction. Intelligent use of graphic control measures and a complete understanding of the commander's intent (two levels up) become even more important to mission accomplishment.

6-4. METT-TC FACTORS

The analysis of the factors of METT-TC is critical for successful planning and execution during UO.

a. **Mission.** The company commander (or platoon leader) must receive, analyze, and understand the mission before he begins planning. The conditions of the operation--either precision or high intensity--and the ROE must be clearly understood and stated. As stated earlier, an antiarmor company commander may be required to conduct different missions simultaneously.

(1) **Common Missions.** Antiarmor units should expect to receive the same type of offensive missions in urban terrain that they receive in other terrain. The following are common missions in UO.

(a) *Isolation of an Urban Objective.* The antiarmor unit normally conducts this mission as part of a battalion. An antiarmor company deploys its platoons to secure the area in order to destroy or fix any withdrawing enemy armor forces and to prevent armor or mechanized reinforcement of a counterattack against the objective.

(b) *Seizure of Key Urban Terrain.* Infantry companies may seize key terrain in order to provide an advantage to friendly forces. Antiarmor platoons (or sections) under OPCON of these companies are critical in isolating these areas and preventing enemy armor or mechanized elements from escaping or entering these areas. Key terrain may be overpasses, building complexes, traffic circles, surrounding natural terrain or bridges, and so forth.

(2) **Analysis of Mission.** When conducting his analysis, the company commander (or platoon leader) must consider his higher commander's intent and the end state of the operation. He must also consider how and where the unit must be postured in order to conduct follow-on missions and to facilitate the battalion and brigade missions. This influences the missions he gives to his subordinate unit (and attached element) leaders.

(3) **Coordination of Fire Support.** Most fire support coordination occurs at battalion level to take into account the ROE. Prior coordination determines the techniques and procedures to use for communicating, identifying targets, and shifting fires. The battalion must plan fires consistent with the ROE, giving extra consideration to civilians, houses of worship, medical centers, schools, public services, and historical monuments.

b. **Enemy.** Key factors that affect the leader's analysis are the type of enemy force that is expected in the urban area, their probable courses of action, and the ROE. More restrictive ROE work to a defender's advantage; conversely, less restrictive ROE work to an attacker's advantage. The type of threat is one factor used to determine how the company should be task-organized and how combat power should be synchronized to

accomplish the mission. Additionally, the company commander (or platoon leader) must determine if there are any unconventional (asymmetric) threats that may affect the unit's mission. For example, if an antiarmor company has the mission to safeguard (secure) a water treatment facility that is determined to be key terrain, the commander needs to consider possible threats to the facility that may not be direct force-on-force actions.

(1) **Conventional Forces.** Many third world countries have adopted techniques of urban combat from either the United States or the Commonwealth of Independent States. Therefore, a future threat may consider the motorized or mechanized rifle battalion the most effective unit for urban combat because of its inherent mobility, armor protection, and ability to adapt buildings and other structures for defense quickly.

(a) In countries that have forces equipped and trained, such as in the former Warsaw Pact, there are standard urban defenses:

- Threat defenses are organized into two echelons to provide greater depth and reserves.
- Company strongpoints are prepared and form the basis for the battalion defensive position.
- The reserve is located in a separate strongpoint.
- Ambush locations are established in the gaps of the strongpoints, and dummy strongpoints are constructed to deceive the attacker.
- Positions for securing and defending the entrances to and exits from underground structures and routes are established.
- Security positions are prepared forward of first echelon defensive positions.
- A motorized or mechanized rifle company may defend several buildings with mutually supporting fires or a single large building.
- Each platoon defends one or two buildings or one or two floors of a single building.

(b) In many third world countries, the forces are predominantly light with some outdated, yet effective, armored vehicles. Some countries may not have actual armed forces but have some form of armed militia(s). These forces normally do not fight a defense in the former Warsaw Pact style, but rather offer uncoordinated resistance, often extremely intense, as experienced in Somalia.

(2) **Unconventional (Asymmetric) Forces.** Enemy analysis is similar to that for urban counterinsurgency, counter guerrilla, and counterterrorist operations.

c. **Terrain.** Offensive operations must be tailored to the urban environment based on a detailed analysis of each urban terrain setting, its types of built-up areas, and existing structural forms. Commanders and subordinate leaders must incorporate the following special planning considerations for an urban environment when conducting an offensive operation:

- Military maps that may not provide enough detail for urban terrain analysis nor reflect the underground sewer system, subways, underground water system, mass transit routes, and utility facilities. (When available, the commander should utilize building or city plans, engineering prints, aerial photographs, tourist maps, or other aids that may assist him in his analysis of the terrain.)
- Natural terrain surrounding the built-up area.

- Key and decisive terrain (stadiums, parks, sports fields, school playgrounds, public buildings, media facilities, and industrial facilities).
- Construction and structural composition of buildings.
- Confined spaces that limit observation, fields of fire, and maneuver and prevent the concentration of fires at critical points.
- Covered and concealed routes to and within the built-up area.
- Limited ability to employ maximum combat power due to the need to minimize damage and rubble effects (based on ROE).
- Problems with conducting effective reconnaissance during conventional operations. (Reconnaissance by force is the most effective reconnaissance means, ROE permitting. This method involves probing a defense with successively larger units until enemy positions are disclosed and can be successfully attacked. During unconventional (asymmetric) operations or operations under restrictive ROE, the opposite is true. Reconnaissance and security are more easily accomplished by both sides and are more difficult to prevent.)
- ROE that limit the use of firepower.
- Significant numbers of civilians who may have to be evacuated, some forcibly. Civilians may hinder operations deliberately or merely by their presence.

d. **Troops Available.** Infantry companies normally participate in an attack as part of an attacking battalion. In this case, the antiarmor unit supports by isolating the objective or places subordinate units under OPCON to the infantry. In some circumstances, antiarmor companies may have infantry attached to participate in the attack within the built-up area.

e. **Time.** Offensive operations in built-up areas have a slower operational tempo than other offensive operations. Leaders must consider the following issues when analyzing time available for a UO attack:

(1) Clearing and isolating blocks or axes of advance in the dense environment of urban terrain requires more time than do operations in more open terrain.

(2) Troops tire more quickly because of stress and the additional physical exertion related to clearing urban terrain. Plan additional time to recover from fatigue.

(3) Allow additional time for thorough reconnaissance and rehearsals in order to prevent excessive casualties and fratricide.

f. **Civil Considerations.** Enforcing the ROE is critical. Leaders must incorporate plans to evacuate civilians into the plan. Leaders must also limit the collateral damage (as dictated in the ROE). Undamaged infrastructures are of great use to antiarmor units.

6-5. BATTLE COMMAND

Units in built-up areas frequently fight separated and isolated from one another (noncontiguous areas of operation). Planning is centralized, but execution is decentralized. In all situations, leaders should position themselves well forward so that they can control the action and provide assistance to subordinate leaders. In urban terrain, this is even more critical due to obstacles, poor visibility, difficulty in communications, and the intensity of urban combat. Leaders must demand timely, accurate, and complete

reporting and must plan for effective command and control to lessen the effects of the urban environment.

a. **Command.** Subordinate units require mission orders that are restrictive in nature. Antiarmor commanders (and platoon leaders) should use detailed control measures to facilitate decentralized execution. Increased difficulties in command, control, and communications from higher headquarters demand increased responsibility and initiative from subordinate leaders. Graphic control measures common to other tactical environments are also used in combat in built-up areas. These and other control measures ensure coordination throughout the chain of command.

b. **Control.** Thorough rehearsals and detailed briefbacks also enhance control. It is important that antiarmor subordinate leaders clearly understand the commander's intent (two levels up) and desired mission end state in order to facilitate control.

(1) **Establish Communications.** In built-up areas, radio communications are often less effective than field telephones and messengers. Communications equipment may not function properly because of the materials used in the construction of buildings and the environment. Wire laid at street level is easily damaged by rubble and vehicle traffic. Pyrotechnic signals are hard to see because of buildings and smoke. The high noise level of battles within and around buildings makes sound signals and voice alerts difficult to hear, and voice communication can also signal the unit's intention and location to the enemy. Line-of-sight limitations affect both visual and radio communications. Therefore, the time needed to establish an effective communications system might be greater in an urban environment. Leaders should consider these effects when they allocate time to establish communications. Since the effectiveness of normally dependable communications may be uncertain during UO, units may fight without continuous communications. Unit SOPs become significantly more important in the urban environment.

(2) **Graphic Control Measures.** The use of graphic control measures to augment the understanding of the commander's intent two levels up by all leaders becomes even more important to successful mission accomplishment in an urban environment. Leaders can use phase lines to report progress or to control the advance of attacking units and limits of advance to prevent fratricide.

(a) When attacking to seize a foothold, the infantry company commander normally assigns a building or a few small buildings as a platoon's first objective. When an objective extends to a street, only the near side of the street is included in the objective area. The company's final objective may be buildings at the far edge of the built-up area or key terrain on the far side. Key buildings or groups of buildings may also be assigned as intermediate objectives. To simplify assigning objectives and reporting, all buildings along the route of attack should be identified (by SOP). Figure 6-2, page 6-12, is an example of using numbers for identification.

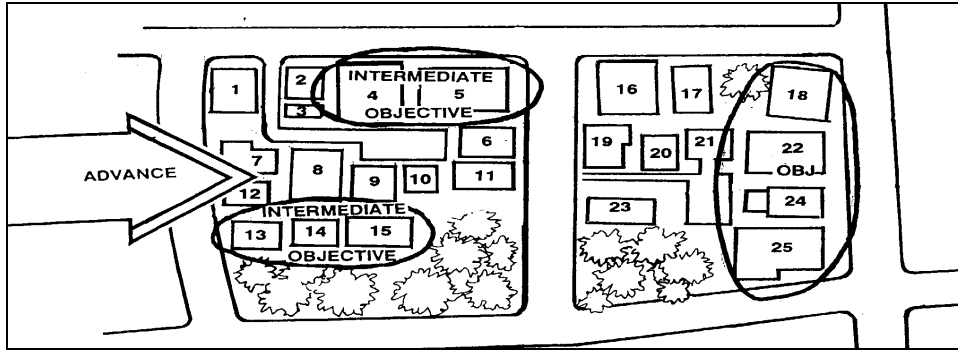

Figure 6-2. Example of a numbering system.

(b) When the company is involved in clearing a designated area of operation, bypassing buildings increases the risk of attack from the rear or flank. Thus, the clearing unit must enter, search, and clear each building in its area of operation or have the antiarmor elements isolate it by fire or other means. A single building may be an objective for a rifle squad or, if the building is large, for a rifle platoon or even a company. When the infantry commander's concept is based on speed or when conducting a hasty attack, a company may be directed not to clear throughout its entire area of operation.

(c) Phase lines can be used to report progress or to control the advance of attacking units (Figure 6-3). Principal streets, rivers, and railroad lines are suitable phase lines, which should be on the near side of the street or open area. In systematic clearing, an antiarmor unit may have the mission to secure the area of operation for the infantry units up to a phase line. In that case, the antiarmor unit leader chooses his own objectives when assigning missions to his subordinate units.

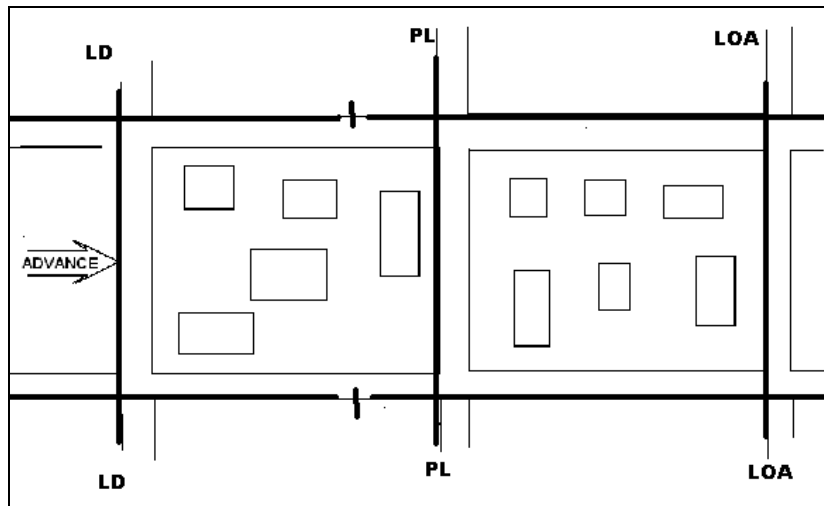

Figure 6-3. Boundaries and phase lines.

(d) The unit leader sets unit boundaries within blocks so that a street is included in a unit's AO. Place boundaries to ensure both sides of a street are within one unit's AO.

(e) The unit leader considers the factors of METT-TC and plans checkpoints and contact points at street corners, buildings, railway crossings, bridges, or any other easily identifiable urban feature.

(f) Forward units may occupy an attack position for last-minute preparation and coordination. The attack position is often behind or inside the last covered and concealed position, such as a large building, before crossing the line of departure. The LD should be the near side of a linear terrain features, such as a street or rail line.

6-6. MOVEMENT

A unit moving in built-up areas follows the same fundamentals and principles and uses the same movement techniques as in other areas. Enemy actions against an antiarmor unit might consist of ambushes on the street, enfilade fire down the streets, sniper fire, fire from rooftops and from within buildings, or artillery or mortar fire. The unit can minimize the effects of enemy defensive fires during movement by--

- Using covered routes.
- Moving only after defensive fires have been suppressed or obscured.
- Moving at night or during other periods of limited visibility.
- Selecting routes that will not mask friendly suppressive fires.
- Crossing open areas (streets and spaces between buildings) quickly under the concealment of smoke with suppression provided by support forces.
- Using the concealment provided by shaded areas.
- Creating deceptions.
- Suppressing known or suspected enemy positions, as allowed by ROE.

a. **Speed of Movement.** As in all urban situations, units must search for defenders in 360 degrees and in all three dimensions. The speed of movement depends on the type of operation, terrain, and degree of enemy resistance. As in any other terrain, the faster the speed of movement the lesser the degree of security and the slower the speed the more secure the movement. In lightly defended areas, the mission or the requirement for speed may dictate moving through the streets and alleys in order to reach and secure key terrain. More importantly, the higher commander must establish and enforce the tempo of the operation.

b. **Danger Areas.** As in any other type of terrain, danger areas should be avoided if possible. Unlike other terrain, almost everything is a danger area in urban terrain. Types of urban danger areas include, but are not limited to--

- Open areas.
- Parking lots and garages.
- Intersections.
- Streets, alleys, and roadways.
- Traffic circles and cul-de-sacs.
- Bridges, overpasses, and underpasses.
- Subterranean areas.
- Rooftops.

6-7. ISOLATE AN URBAN OBJECTIVE

Antiarmor companies (or platoons) routinely support in the isolation of urban objectives in order to prevent reinforcement of or counterattack against the objective and to destroy or capture any withdrawing enemy mobile forces. When planning the isolation, leaders must be aware of the considerations involved in the three-dimensional and in-depth isolation of the objective (front, flanks, rear, upper stories, basements and rooftops). All available direct and indirect fire weapons should be employed, consistent with the ROE. Isolating the objective is a key factor in facilitating the assault and preventing casualties. The antiarmor company (or platoon) may perform this mission as the support element for a battalion operation, or it may assign the task to one of its subordinate units during an infantry battalion attack operation. In certain situations, antiarmor units may be required to isolate an objective or an area for special operations forces.

a. **Isolating the Objective (Infantry Battalion Attack).** An antiarmor company (or platoon) may isolate the objective as a support element for a battalion operation. When an antiarmor company has this mission, the battalion's objective is normally a larger structure or group of blocks. The company commander tasks his platoons and assigns them to support-by-fire positions based on an analysis of the factors of METT-TC. In addition to isolating the objective, an antiarmor company may have additional tasks to conduct on order or simultaneously. Examples of these additional tasks include providing the battalion reserve, handling civilians and EPWs, and performing medical evacuation (MEDEVAC).

b. **Isolating the Objective (Infantry Company Attack).** When an infantry company conducts an attack, the task organization and tasks given to an antiarmor platoon (or section) are determined by an analysis of the factors of METT-TC. If the infantry company conducts a company attack, the objective can be a building, a block, a traffic circle, or a village (Figure 6-4). See Figure 6-5 for a technique of controlling direct fires during the assault.

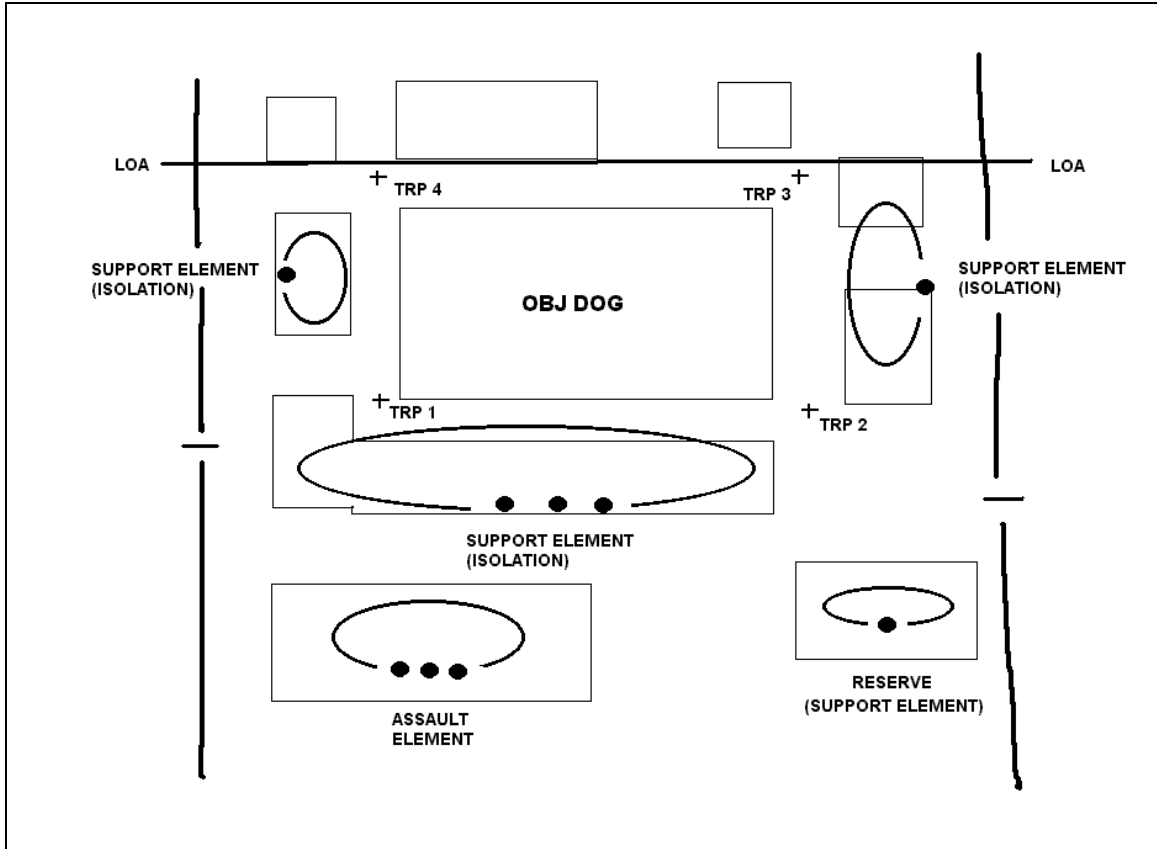

Figure 6-4. Isolating an urban objective.

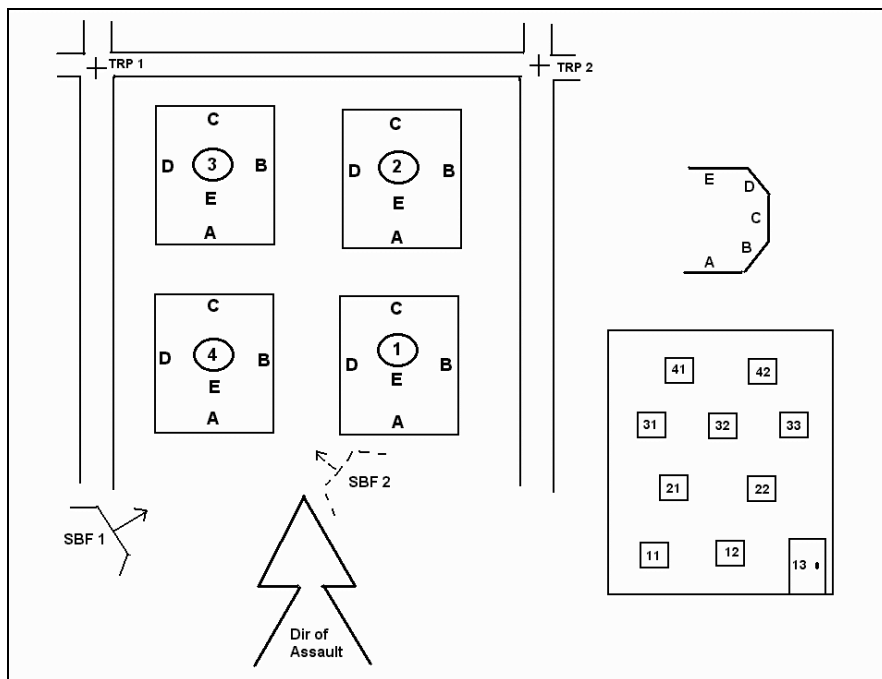

Figure 6-5. Direction of assault technique for direct fire planning and control.

6-8. ATTACK A BLOCK OR GROUP OF BUILDINGS

An infantry company normally attacks a block or group of buildings as part of a battalion attack. To attack a block or group of buildings, an infantry company likely will be reinforced with an antiarmor platoon (or section) and possibly engineers, mobile gun systems (MGS), Bradley fighting vehicles (BFVs), or tanks, consistent with the ROE and the enemy situation.

a. **Execution.** The execution of this mission is characterized by infantry platoon attacks supported by both antiarmor and infantry direct fires and indirect fires. Success depends on isolating enemy positions (which often become platoon objectives), suppressing enemy weapons, seizing a foothold in the block, and clearing the buildings room by room.

b. **Direct Fire Weapons.** Direct fire support weapon systems fire on the objective from covered positions, consistent with the ROE. These weapons should not be fired for prolonged periods from one position. Antiarmor squads, like other crew-served weapons crews, should use a series of positions and displace from one to another to gain better fields of fire and to avoid being targeted by the enemy. Direct fire support tasks can be assigned as follows:

- M240Bs fire along streets and into windows, doors, mouseholes, and other probable enemy positions. ROE may restrict firing only to known enemy locations.
- MK19s fire at targets protected by walls and provide protection against enemy vehicles, as required.
- M2s suppress enemy positions.
- Riflemen engage targets of opportunity.

6-9. CONSOLIDATION AND REORGANIZATION

Consolidation occurs immediately after each action. Consolidation provides security and allows a unit to prepare for counterattack. In an urban environment, it is extremely important that units consolidate rapidly after each engagement. After securing a floor, selected members of the assault force and antiarmor elements cover potential enemy counterattack routes to the building. Priority must be given to securing the direction of attack first. Reorganization is action taken that shifts internal resources within a degraded unit to increase its level of effectiveness. Given the resource-intensive environment during UO, it is important for units to plan for and conduct reorganization activities throughout the operation, as much as possible.

a. **Consolidation Actions.** Antiarmor elements assume hasty defensive positions after the objective has been seized or secured and prepare for possible enemy counterattacks. Based upon their specified and implied tasks, antiarmor elements should be prepared to occupy an overwatch position to support an assault on another building.

b. **Reorganization Actions.** Reorganization actions do not necessarily wait on the consolidation activities. These actions include the following:

- Resupply and redistribute ammunition and equipment.
- Refuel vehicles as necessary.
- Treat and evacuate wounded personnel.
- Treat and process EPWs.

- Segregate and safeguard civilians.
- Reestablish the chain of command.

Section III. DEFENSE

The two types of defense operations (area and mobile) still apply in UO. Of these two types, the mobile defense is more focused on the enemy. The commander may decide to use this type of defensive operation based on his analysis of the factors of METT-TC. The area defense is more appropriate when most of the reasons for defending a built-up area are focused on retaining terrain. In a built-up area, the defender must take advantage of inherent cover and concealment afforded by urban terrain. He must also consider restrictions to the attacker's ability to maneuver and observe. By using the terrain and fighting from prepared and mutually supporting positions, a defending force can delay, block, fix, or inflict heavy losses on a much larger attacking force. The defense of a built-up area should be organized around key terrain features, buildings, and areas that preserve the integrity of the defense and provide the defender ease of movement. The defender must organize and plan his defense by considering obstacles, avenues of approach, key terrain, observation and fields of fire, cover and concealment, fire hazards, and communications restrictions.

6-10. METT-TC FACTORS

Procedures and principles for planning and organizing the defense of a built-up area are the same as for other defensive operations. In developing a defensive plan, the defender considers the factors of METT-TC, emphasizing their impact on fire support, preparation time, work priorities, and control measures. Planning for the defense of a built-up area must be detailed and centralized. As in the offense, execution is decentralized as the battle develops and enemy forces assault buildings and rooms. Therefore, it is imperative that the company commander (or platoon leader) and his subordinate leaders understand the mission end state and the commanders' intent two levels up.

a. **Mission.** The commander (or platoon leader) must receive, analyze, and understand the mission before he begins planning. He may receive the mission as a FRAGO or formal OPORD, and he must analyze all specified and implied tasks. Depending on mission requirements, an antiarmor company must be prepared to defend independently or as part of a larger force. Antiarmor platoons in light infantry battalions will typically defend as part of a larger force. Mission planning is essentially the same for all defensive operations. A hasty defense may be conducted in any of the situations described below, immediately after offensive operations, or when a higher state of security is warranted during stability operations. The major difference lies in the amount of preparation and the ROE.

b. **Enemy.** The commander (or platoon leader) must also analyze the type of enemy force he may encounter. If the attacker is mostly armored or mounted motorized infantry, the greatest danger is that he will mass direct fire and destroy the defender's positions. If the attacker is mostly infantry or is employing asymmetric applications of combat power, such as guerrillas or terrorists, he will temporarily mass his combat power against the defender's perceived weakness, then quickly move away. This attacker will not stay and fight for long periods of time. Enemy analysis during defensive operations in built-up areas is not limited to only studying the enemy. Commanders must emphasize obtaining

and using all intelligence. The items of intelligence peculiar to combat in built-up areas include--

- Street, water, and sewer plans.
- Key installations and facilities.
- Key civilians.
- Civilian police and paramilitary forces.
- Communications facilities and plans.
- Power stations.

c. **Terrain.** Terrain in built-up areas is three-dimensional: ground level (streets and parks), above ground (buildings), and below ground (basements, subways and sewers). Analysis of all manmade and natural terrain features is critical when planning to defend a built-up area. The type of built-up area in which a unit will operate affects the defensive plan.

(1) **Villages.** Villages are often on choke points in valleys, dominating the only high-speed avenue of approach through the terrain. If the buildings in such a village are well constructed and provide good protection against both direct and indirect fires, a defense can be mounted by placing antiarmor elements in the town while controlling close and dominant terrain with other infantry elements. Commanders may use villages on approaches to large towns or cities to add depth to the defense or to secure the flanks. These villages often are characterized by clusters of houses and buildings (stone, brick, or concrete). Company-sized battle positions (three to four platoons) can be established in these small villages to block approaches into the main defensive positions.

(2) **Strip Areas.** Strip areas consist of houses, stores, and factories and are built along roads or down valleys between towns and villages. They afford the defender the same advantages as villages. If visibility is good and enough effective fields of fire are available, a unit acting as a security force need occupy only a few strong positions spread out within the strip. This will deceive the enemy, when engaged by antiarmor elements at long ranges, into thinking the strip is an extensive defensive line. Strip areas often afford covered avenues of withdrawal to the flanks once the attacking force is deployed and before the security force becomes decisively engaged.

(3) **Towns and Cities.** When facing a predominantly armored enemy, a small force can gain an advantage in combat power when defending a small city or town that is a choke point if it places antiarmor weapon systems (TOW, M2, or MK19) on positions dominating critical approaches. To deny the enemy the ability to bypass the town or city, the defending force must control key terrain and coordinate with adjacent forces. Reserve forces should be placed where they can quickly reinforce critical areas. Obstacles and minefields assist in slowing and canalizing the attacker.

(a) Finding positions in towns and cities that provide both good fields of fire and cover is often difficult. The forward edges of a town usually offer the best fields of fire but can be easily targeted by enemy overwatch and supporting fire. These areas often contain residential buildings constructed of light material. Factories, civic buildings, and other heavy structures, which provide adequate cover and are more suitable for defending, are more likely found deeper in the town. These locations will have limited fields of fire on the likely avenues of approach.

(b) Since the forward edge of a town is the obvious position for the defender, it should be avoided. However, the defender can set up his position there if the terrain

limits the enemy's ability for engagement or contains strongly constructed buildings that give defending units adequate protection.

(c) An antiarmor unit may initially be assigned battle positions on the forward edge of the town to provide early warning of the enemy's advance. The force engages the enemy at long range, typically with TOW missiles, and deceives the enemy as to the true location of the defense. This force should withdraw in time to avoid decisive engagement. If there is limited observation from the forward edge, a task organized force should be positioned on more favorable terrain forward or to the flanks of the town to gain better observation and to engage the enemy at long range.

(d) In a large built-up area, a company or battalion has a sector, battle position(s), or a strongpoint to defend. Although mutual support between positions should be maintained, built-up terrain often allows for infiltration routes that the enemy may use to pass between positions. Therefore, the defender must identify the following:

- Positions that enable him to place effective antiarmor direct fires on the infiltrating enemy (especially MK19 fires).
- Covered and concealed routes for friendly elements to move between positions (subways and sewers).
- Areas where antiarmor weapons have effective fields of fire, such as parks, boulevards, rivers, highways, and railroads.
- Command and control locations that offer cover, concealment, and ease of communications.
- Protected storage areas for supplies.

(4) **Obstacles.** A built-up area is itself an obstacle since it canalizes and impedes an attack. Likely avenues of approach should be blocked by obstacles (Figure 6-6, page 6-20) and covered by direct and indirect fire. Barriers and obstacles should be emplaced in three belts and consistent with the ROE.

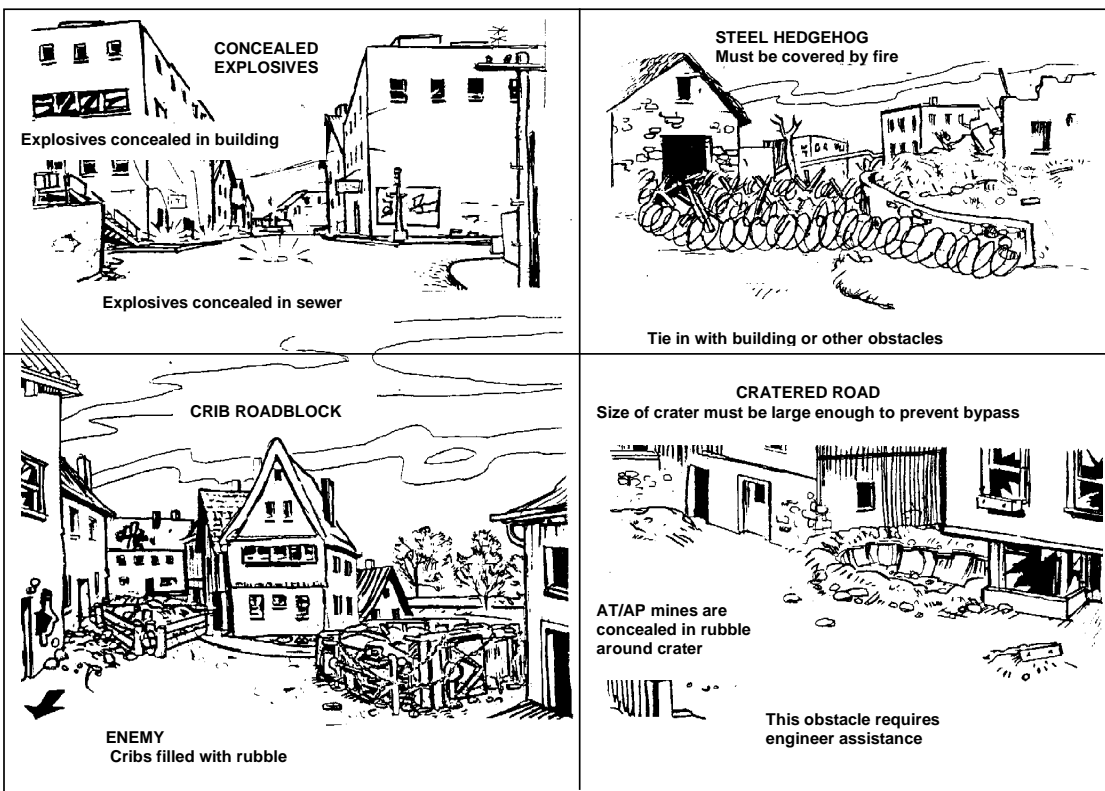

Figure 6-6. Example of urban obstacles.

(5) *Avenues of Approach*. The defender must consider not only the conventional avenues of approach into and out of the city but also the avenues above and below ground level within built-up areas. The defender normally has the advantage. He knows the built-up area and can move rapidly from position to position. Control of these avenues of approach becomes more critical when the defense of key terrain must be oriented against terrorism and sabotage. All avenues of approach (three-dimensionally) must be denied. When necessary, obstacles can be emplaced without mines and covered by fire within the parameters of the ROE.

(6) *Key Terrain*. Key terrain is any place where seizure, retention, or control affords a marked advantage to either combatant. Examples of key terrain during UO are bridges over canals or rivers, building complexes, public utilities or services, and parks. The population of a built-up area may also be considered key terrain. The identification of key terrain allows the defender to select his defensive positions and assists in determining the enemy's objectives.

(7) *Observation and Fields of Fire*. The defender must position weapon systems to obtain mutual supporting fire and maximum effect. This allows for long-range engagements out to the maximum effective ranges. Observers should be well above street level to adjust fires on the enemy at maximum range. Indirect fires, especially FPFs, should be preplanned and, if possible and ROE permitting, preregistered on the most likely approaches to allow them to be shifted rapidly to threatened areas.

d. **Troops Available**. Urban operations are manpower intensive.

(1) *Employment of Antiarmor Units*. Once the infantry commander has decided where to defend, he should integrate antiarmor elements into select battle positions or

sectors that block or restrict the enemy's ability to maneuver and control key areas. The frontage for an infantry platoon is about one to two city blocks long. Infantry platoons can occupy about three small structures or a larger two- to three-story building (Figure 6-7). Along with his primary and alternate positions, the infantry platoon leader normally selects one supplementary position to reorient his defense to meet enemy threats from another direction. Antiarmor companies (or platoons) may be tasked to detach a subordinate unit to be incorporated into the infantry battalion reserve.



Figure 6-7. Platoon battle positions in a company sector.

(2) **Employment of Antiarmor Weapon Systems.** The commander should employ antiarmor weapon systems to take advantage of their long-range fires and mobility. Some built-up areas may restrict the mobility of these vehicles and make them vulnerable to the enemy. Mutually supporting infantry should be positioned to provide security against close enemy direct fires and to identify targets for the antiarmor elements. Antiarmor elements should be assigned engagement areas in support of the defensive scheme of maneuver. The infantry unit's Javelins and AT4s should supplement the antiarmor unit's weapons systems. Antiarmor weapon systems may be--

- Positioned on the edge of the city in mutually supporting positions.
- Positioned on key terrain on the flanks of towns and villages.
- Used to cover barricades and obstacles by fire.
- Part of the reserve.

(3) **Employment of Fire Support.** Indirect fire planning must be comprehensive due to the proximity of buildings to targets, minimum range restrictions, repositioning requirements, and ROE. Mortar and artillery fires are planned on top of and immediately around defensive positions for close support.

(a) **Artillery.** Artillery may be used as direct or indirect support. Artillery fire should be used--

- To suppress or obscure enemy overwatch elements.
- To disrupt or destroy an assault.
- To provide counterbattery fire.
- To support counterattacks.
- To provide direct fire when necessary.

(b) **Final Protective Fires.** A final protective fire is planned to stop dismounted assaults in front of the defensive positions. Indirect fires within the city are planned along likely routes of advance to destroy the enemy as he attempts to deepen a penetration.

(c) **Priorities of Fire.** The company commander (or platoon leader) should establish priorities of fire based on enemy avenues of approach and enemy systems that present the greatest danger to the defense. For example, during the attacker's initial advance, tanks, armored personnel carriers, and overwatching elements are the greatest threat to the defense. TOWs, M2s, and Javelins should concentrate on destroying armored vehicles. In certain situations, enemy armored vehicles may provide a greater threat than enemy tanks in a built-up area; the armored vehicles carry infantry that can gain footholds in buildings. Mortar and artillery fires should suppress enemy ATGMs and overwatch positions or elements. If enemy formations secure a foothold, priority shifts to the destruction of the penetrating enemy forces.

(d) **Control of Supporting Fires.** As the attack progresses in the city, enemy indirect fires increase to separate infantry from supporting weapons (for example, antiarmor unit weapon systems). During this phase, friendly artillery concentrates on counterfire missions and the destruction of reinforcements that are approaching the city. Mortars continue to concentrate on infantry attacks.

(e) **Support of Counterattacks.** When initiated, counterattacks are given priority of supporting fires. When artillery is firing the missions mentioned above, it must remain mobile and be prepared to displace to preplanned positions to avoid enemy counterbattery fire.

(f) **Indirect Fire Planning.** At company and platoon level, indirect fire plans include fires of attached and supporting weapons. The company commander (or platoon leader) also plans mortar and artillery fires on and immediately around his battle positions for close support.

(g) **Air Defense Assets.** Air defense assets available to the commander, such as Stinger and Avenger, are normally employed to ensure all-round air defense. These assets are normally controlled at brigade (SBCT) or battalion level, but they may be placed under a company commander's control when METT-TC factors warrant that type of use. The lack of good firing positions for long-range air defense missile systems in the built-up area may limit the number of deployed weapons. In the defense, weapons systems may have to be winched or airlifted into positions. Stingers and Avengers can be assigned to protect specific positions or function in general support of the battalion.

(4) **Employment of the Reserve.** The commander's defensive plan must always consider the employment of a reserve. The reserve force should be prepared to counterattack to regain key positions, to block enemy penetrations, to protect the flanks, or to assist by fire in the disengagement and withdrawal of positions. For combat in a built-up area, a reserve force--

- Normally consists of infantry.
- Must be as mobile as possible.
- May be supported by an antiarmor unit.
- May be an antiarmor company with infantry attached.

e. **Time Available.** The commander must organize and establish priorities of work, depending upon the time available. Many tasks can be accomplished simultaneously, but priorities for preparation should be in accordance with the commander's order. A sample priority of work sequence is described in the following paragraphs.

(1) **Establish Security.** The unit should quickly establish all-round security by placing forces on likely avenues of approach. The factors of METT-TC determine the level of security (for example, 50 percent or 30 percent).

(2) **Assign Areas of Responsibility.** Boundaries define responsibility in terms of areas of operation or sectors. They include areas where units may fire and maneuver without interference or coordination with other units. Responsibility for primary avenues of approach should never be split. In areas of semi-detached construction where observation and movement are less restricted, boundaries should be established along alleys or streets to include both sides of a street in a single AO or sector. Where buildings present a solid front along streets, boundaries may have to extend to one side of the street. Battle positions also should be specifically assigned to platoons.

(3) **Clear Fields of Fire.** In built-up areas, defenders may need to rubble certain buildings and structures to provide greater protection and better fields of fire. Rubbling an entire building can increase the fields of fire and create an obstacle to enemy movement. Defenders must be careful, however. Rubbling buildings too soon or rubbling too many may give away exact locations and destroy cover from direct fire. Planning must be extensive so that rubble buildings will not interfere with planned routes of withdrawal or counterattack.

(4) **Select and Prepare Initial Fighting Positions.** The company commander (or platoon leader) should select positions in depth. The unit should start preparing positions as soon as possible and continue preparing as long as positions are occupied. Enemy infiltration or movement sometimes occurs between or behind friendly positions. Therefore, each position must be organized for all-round defense. The defender also should --

- Remove combustible material to limit the danger of fire. Fires are dangerous to defenders and create smoke that could conceal attacking troops. For these reasons, defenders should remove all flammable materials and stockpile firefighting equipment (such as water and sand). The danger of fire also influences the type of ammunition used in the defense. Tracers or incendiary rounds should not be used extensively if threat of fire exists.
- Turn off electricity and gas. Both propane and natural gas are explosive. Natural gas is also poisonous, displaces oxygen, and is not filtered by a protective mask. Propane gas, although not poisonous, is heavier than air. If it

leaks into an enclosed area, it displaces the oxygen and causes suffocation. Gas mains and electricity should be shut off at the facility that serves the urban area.

- Camouflage positions.
- Prepare range cards, fire plans, and sector sketches.
- Cache resupply of ammunition, water, and medical supplies.

(5) **Establish Communications.** When allocating time to establish communications, defenders should consider the effects of built-up areas. Line-of-sight limitations affect both visual and radio/digital communications. Wire laid at street level is easily damaged by rubble and vehicle traffic. The noise of combat in built-up areas is much louder than in other areas, making sound signals difficult to hear. Therefore, the time needed to establish an effective communications system in urban terrain may be greater than in other terrain.

(a) Use existing telephone systems. However, telephones are not secure even though many telephone cables are underground.

(b) Use messengers at all levels since they are the most secure means of communications.

(6) **Emplace Obstacles and Mines.** To save time and resources in preparing the defense, defenders must emphasize using all available materials (to include automobiles, railcars, and rubble) to create obstacles. Civilian construction equipment and materials must be located and inventoried. This equipment can be used with engineer assets or in place of damaged equipment. Coordination must be made with proper civilian officials before use, which is normally a brigade or battalion staff responsibility. Engineers must be able to provide advice and resources as to the employment of obstacles and mines.

(7) **Establish and Mark Routes between Positions.** Reconnaissance by all defending elements assists in route selection for use by defenders moving between positions. Movement is crucial to fighting in built-up areas. Early selection and marking of routes adds to the defender's advantages.

f. **Civil Considerations.** International law and moral imperatives require leaders to consider the effects of operations on the civilian population. The company commander must also consider cultural, economic, and political boundaries as they may have a direct impact on the range of tactical options available to him.

(1) Commanders may be precluded from countermobility operations directed at economically important roads, railways, and bridges. They must consider civilian movement when emplacing minefields. Commanders implement restrictive fire control measures consistent with ROE.

(2) Units with large civilian populations in their AO often must conduct support operations while preparing a defense. When Army forces must damage areas that are important to civilians, they ensure that civilian leaders and populations understand why these actions are necessary.

g. **Fire Hazards.** The defender's detailed knowledge of the terrain permits him to avoid areas that are likely to be fire hazards. All urban areas are vulnerable to fire, especially those with many wooden buildings. The defender must be prepared to fight a fire as he fights the enemy. The defender may deliberately set fires--

- To disrupt and disorganize the attackers.
- To canalize the attackers into more favorable antiarmor engagement areas.

6-11. COMMAND AND CONTROL

In all defensive situations, the antiarmor leader should position well forward so that he can control the action. Regardless of the utility of FBCB2 (if available), the leader must see and feel the battlefield. In urban terrain, this is even more critical due to obstacles, poor visibility, difficulty in communication, and intense fighting.

a. **Graphic Control Measures.** The use of graphic control measures and understanding the commander's intent two levels up by all leaders become even more important to mission accomplishment in an urban environment. Phase lines can be used to report the enemy's location or to control the advance of counterattacking units. Principal streets, rivers, and railroad lines are suitable phase lines. They should be clearly and uniformly marked on the near or far side of the street or open area. Checkpoints aid to report friendly locations and control movement. Contact points are used to designate specific points where friendly units make physical contact and pass information. TRPs can facilitate fire control. These and other control measures ensure coordination throughout the chain of command.

b. **Command Posts.** A unit's command post requires all-round security. Since each CP may have to secure itself, it should be near the reserve unit for added security. When collocated with another unit, however, CPs may not need to provide their own security. A simplified organization for CPs is required for ease of movement. Alternate CP locations and routes to them also must be identified.

c. **Actions on Contact.** When enemy forces enter and maneuver to seize initial objectives, the defender should employ all available fires to destroy or to suppress the direct-fire weapons that support the enemy's ground attack. Enemy tanks and armored vehicles should be engaged as soon as they come within the effective range of antiarmor weapon systems. As the enemy attack develops, the actions of small-unit leaders assume increased importance. Antiarmor squad and section leaders are often responsible for fighting independent battles. Thus, it is important that all leaders understand the commander's defensive concept and intent (two levels up). Counterattacks should be employed to destroy the enemy in the main battle area.

d. **Counterattacks.** Small infantry-heavy reserves supported by antiarmor elements should be prepared to counterattack to regain key positions, to block enemy penetrations, to provide flank protection, and to assist the disengagement and withdrawal of endangered units. It is especially important for enemy footholds to be repelled. When the reserves counterattack to reinforce a unit, they can be attached to the unit in whose sector the counterattack is taking place; otherwise, the counterattack force becomes the main effort. This makes coordination easier, especially if the counterattack goes through the unit's positions.

e. **Defense During Limited Visibility.** Commanders can expect the attacker to use limited visibility conditions to conduct necessary operations to sustain or gain daylight momentum.

(1) Commanders (or platoon leaders) should employ the following measures to defend against attacks during limited visibility.

(a) Defensive positions should be shifted from an alternate position or a hasty security position just before dark to deceive the enemy as to the exact location of the primary position.

(b) Unoccupied areas between units, which can be covered by observed fire during daylight, may have to be occupied, blocked, or patrolled during limited visibility. Early warning devices need to be installed.

(c) Radar, remote sensors, and night observation devices should be emplaced to cover streets and open areas.

(d) Noise-making devices, tanglefoot tactical wire, and observation posts should be positioned on all avenues of approach for early warning and to detect infiltration.

(e) Artificial illumination should be planned, to include the use of street lamps, stadium lights, pyrotechnics, and so forth.

(f) Indirect fire weapons, grenade launchers (M203), and hand grenades should be used when defenses are probed to avoid disclosure of key weapon systems in defensive positions.

(2) When the enemy begins his assault, FPFs should be initiated by a planned signal. Antiarmor weapon systems, crew-served weapons, armored vehicle-mounted weapons (if available), and individual riflemen fire within their assigned sectors. Grenades and command-detonated mines should supplement other fires as the enemy approaches the positions.

(3) Defenders should move to daylight positions before BMNT. To facilitate movement, buildings should be marked from the friendly side IAW unit SOP.

f. **Communications Restrictions.** FM radio (or digital) communications are initially the primary means of communication for controlling the defense of a built-up area and for enforcing security. Structures and a high concentration of electrical power lines may degrade FM radio (or digital) communication in built-up areas. Wire should be emplaced and used for communications as time permits. However, wire can be compromised if interdicted by the enemy. Messengers can be used as another means of communication. Visual signals can also be used but often are not effective because of the screening effects of buildings and walls. Increased battle noise makes the effective use of sound signals difficult. Signals must be planned, widely disseminated, and understood by all assigned and attached units

6-12. HASTY DEFENSE

A very likely defensive mission for an antiarmor company in urban terrain is to conduct a hasty defense. This mission is characterized by reduced time for the preparation of the defense. All of the troop-leading procedures are the same. The priorities of work are basically the same, but many take place concurrently. Units are deployed, weapons emplaced, and positions prepared in accordance with the factors of METT-TC, especially the amount of time the antiarmor company commander has available.

a. **Occupation and Preparation of Positions.** Preparations for the hasty defense vary with the time available. The preparations described below generally take two to four hours. In a hasty defense, the primary effort is to camouflage and conceal the presence of the hasty fighting positions and provide as much protection as possible for the antiarmor elements manning them. The emphasis on fortifying positions and making major alterations to the environment is reduced. These actions occur after security has been established.

(1) **Emplace Barriers and Obstacles.** Lack of time means two belts of barriers and obstacles are established and they are not as extensive as in a defense that permits more

time. Cover all obstacles with observation and fires. Walk the positions from the enemy side.

(2) **Rehearsals.** Conduct rehearsals with leaders and soldiers concerning such things as the orientation of the defense, unit positions, location of antiarmor weapon systems, counterattack plans, and withdrawal plan.

(3) **Movement Enhancement.** There will not be much time to improve movement within the defense. Priority should be given to removing obstructions along routes to alternate positions and to the counterattack route.

(4) **Communications.** Check communications. Communications are primarily FM radio (or digital). Plans should be made, and routes improved, for messengers. If time is available, wire is emplaced as an improvement to the defense.

b. **Improving the Defense.** As time permits, the following areas can be considered and prioritized in accordance with an analysis of the factors of METT-TC:

- Rest plan.
- Barrier and obstacle improvement.
- Improvement of primary and alternate positions.
- Preparation of supplementary positions.
- Additional movement enhancement efforts.
- Improvement of camouflage.
- Continued rehearsals for counterattack and withdrawal.
- Antiarmor and infantry integration

6-13. COMPANY DEFENSE OF A VILLAGE

A village is characterized as a built-up area surrounded by other types of terrain. Normally, an antiarmor company (or platoon) will defend a village as part of a larger force, establishing battle positions and strongpoints with the infantry units defending from key or decisive terrain. Defending on the leading edge of a village with TOWs, MK19s, and M2s, an antiarmor company can take advantage of longer-range observation and fields of fire. Here the company is more effective against an armor-heavy force. Defending in depth within the village with M2s and MK19s, the antiarmor company can deny the enemy a foothold. Here the company is more effective against a primarily infantry-heavy force. The decision as to which defense to employ is based on a thorough analysis of the factors of METT-TC. Because defending a village usually includes the defense of a built-up area surrounded by open terrain, the antiarmor company may need to coordinate with adjacent units to plan for the defense or control of this terrain.

a. **Influencing Factors.** Several factors influence the commander's decision. First, he must know the type of enemy against which his company will defend. If the threat is armored or motorized infantry, the greatest danger is that massive direct fire will destroy the antiarmor company's defensive positions. The company commander also must consider the terrain forward and to the flanks of the village from which the enemy can direct fires against his positions.

b. **Antiarmor Units under OPCON to Infantry Companies.** The infantry company commander could place the antiarmor platoon (or section) along the leading edge of a village where Javelins can compliment the antiarmor unit's direct fires. The antiarmor leader should select exact firing positions for his unit and should recommend engagement areas to the infantry company commander. If faced by enemy infantry, the

antiarmor unit (with M2 and MK19 mounted) moves to alternate positions with the protection of the infantry. These alternate positions allow the antiarmor unit to engage to the front as well as the flanks with as little movement as possible. Positions can be selected within buildings, and mouse holes can be constructed. After they are withdrawn from the leading edge of the village, the antiarmor unit also can provide a mobile reserve for the company.

c. **Company Trains.** The commander identifies a forward area where he can position his unit trains. He chooses a location near the main avenue of approach to ease resupply, recovery, and maintenance operations.

d. **Final Protective Fires.** FPFs are planned to address the biggest threat to the antiarmor unit--the enemy's infantry. When firing an FPF inside a built-up area is required, the battalion mortars are more effective than artillery because of the mortar's higher angle of fall. This higher angle gives the mortars a greater chance of impacting on the street.

e. **Combat Service Support.** Ammunition expenditure usually is high when fighting in a built-up area. To avoid moving around the village with ammunition resupply during the battle, the commander directs that ammunition be stockpiled in each occupied antiarmor unit position. He also orders units to stockpile firefighting equipment, drinking water, food, and first-aid supplies at each position.

f. **Communications.** To ensure adequate and continuous communications, redundant verbal and nonverbal communications are planned and checked. The antiarmor leader develops a plan for pyrotechnic signals. Backup wire should be laid in case vehicles, fires, or the enemy cut primary lines. The antiarmor leader also plans for the use of messengers throughout the village.

6-14. DEFENSE OF A BLOCK OR GROUP OF BUILDINGS

An antiarmor company (or platoon) normally conducts a defense of a city block or group of buildings as part of a larger force conducting a sector defense in a built-up area. Company commanders may assign their platoons strongpoints, battle positions, sectors, or any combination of these. A company operating in urban terrain may have to defend a city block or group of buildings in a core periphery or residential area. The antiarmor company (or platoon) conducts this operation in accordance with the commander's defensive scheme of maneuver. The operation should be coordinated with the action of security forces that are charged with delaying to the front of the company's position. The defense should take advantage of the protection of buildings that dominate the avenues of approach into the main battle area. This mission differs from defense of a village in that it is more likely to be conducted completely on urban terrain without the surrounding open terrain that characterizes the defense of a village.

a. **Task and Purpose.** A well-organized company defense in a built-up area--

- Stops the attack of the enemy on streets and city blocks by using obstacles and fire.
- Destroys the enemy by ambush and antiarmor direct fires from prepared positions.
- Remains in place for a counterattack.

b. **Reconnaissance and Security.** The execution of the mission will be more effective if leaders reconnoiter the terrain. Attached infantry should be given the mission

to man observation posts to provide reports concerning the size, activity, location, direction and rate of movement, and type of enemy assaulting the higher unit's sector or battle position.

c. **Task Organization.** As with other operations, an analysis of the factors of METT-TC may determine how the antiarmor company (or platoon) is task-organized and integrated into the battle to accomplish the mission.

d. **Execution.** A defending antiarmor unit should prepare a strong defense, cover obstacles, and ambush on the avenues of approach. A counterattacking antiarmor unit should be near the front of the higher unit's sector in covered and concealed positions with an on-order mission to counterattack. Rehearsals should be conducted both day and night. Counterattack forces also should have specific instructions of what their actions will be after the enemy assault has been repelled (for example, remain in sector or revert back to reserve status).

6-15. DEFENSE OF KEY TERRAIN

An antiarmor company (or platoon) defends key terrain independently or as part of a larger unit. It can form a perimeter defense around key terrain, government center, or command and control facility, for example. The antiarmor unit can establish and operate checkpoints and roadblocks in conjunction with this defense. In many cases, an unclear enemy situation and extremely restrictive ROE may characterize this mission. Often the facilities previously described are sited for their central location and convenience rather than for the defensibility of the terrain. The company commander (or platoon leader) often finds his unit must defend a piece of terrain that he would rather not have to occupy. A thorough analysis of the factors of METT-TC should determine how to defend the terrain.

a. **Task Organization.** Again, an analysis of the factors of METT-TC will determine the task organization of the antiarmor company. Figure 6-8, page 6-30, depicts a task-organized company defending an objective (a water purification plant). Additional assets will be given to a commander as they are requested or assigned, based on mission requirements and availability.

b. **Tasks.** The company commander will need to make a careful mission analysis in order to determine the specified and implied tasks associated with a mission of this type. In the situation shown in Figure 6-8, page 6-30, the company commander has determined that in order to defend the key terrain properly, he needs to deploy platoons on the defensible terrain available. Therefore, he defends urban terrain (left) with an infantry rifle platoon, high ground (top) overlooking a large open area with the antiarmor platoon, and low vegetated terrain (right, bottom) with infantry rifle platoons with antiarmor sections attached. Additionally, some of the tasks listed below may be necessary:

- Provide inner and outer security patrols.
- Establish OPs.
- Establish checkpoints and roadblocks.
- Conduct civilian control and evacuation.
- Conduct coordination with local authorities.
- Prevent collateral damage.
- Supervise specific functions associated with operation of the facility, such as water purification tests or site inspections.

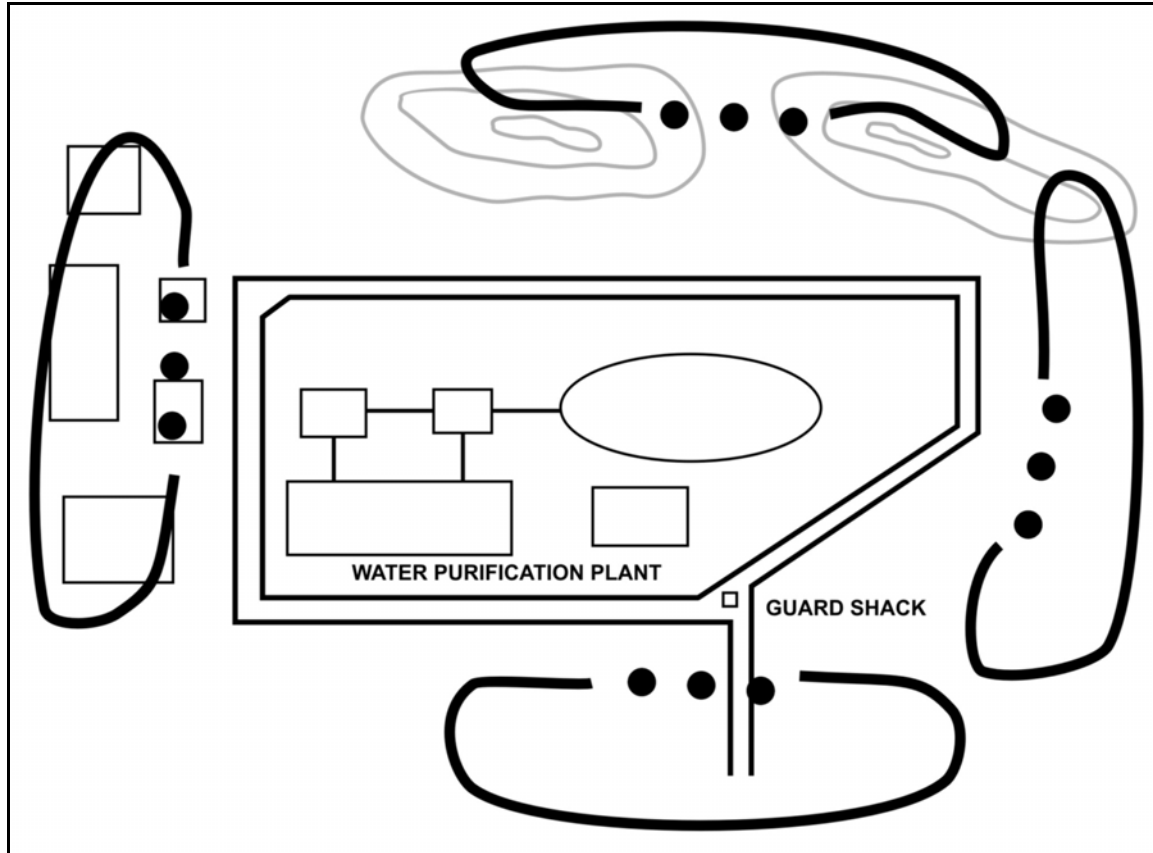

Figure 6-8. Perimeter defense of key terrain.

c. **Execution.** The company commander normally deploys platoons in a perimeter to dominate the key terrain and cover the mounted and dismounted avenues of approach into it. (See FM 7-10 for further information on perimeter defense.) Dismounted infantry and antiarmor elements are emplaced to cover the dismounted and mounted avenues of approach into the objective, respectively. Wire obstacles normally are used to restrict and deny. Key terrain should be covered by fire and rigged with detection devices and trip flares. Antiarmor and command-detonated antitank mines are used, consistent with the ROE. The company must be prepared to defend against a direct attack such as a raid or sabotage against facilities within the key terrain (water filtration system, pump station, and so forth). The commander must make an assessment as to the overall importance of the facilities within the key terrain and prioritize security requirements. Antiarmor elements are positioned to engage vehicle targets. The type of threat will determine the type of antiarmor weapon system to be employed.

d. **Other Considerations.** Depending on the mission requirements and threat, the company commander may have to consider the need for the following:

- Artillery and attack helicopter support.
- Air defense assets to defend against air attack.
- Engineer assets to construct obstacles.
- Interpreters to assist in the functioning of the facility and operation of the equipment.

- Military Police, civil affairs, and psychological operations (PSYOP) assets for civilian control and liaison.
- Coordination with local police and authorities.
- A mobile reserve or reaction force.

e. **Force Protection.** The antiarmor or infantry company may be required to conduct a perimeter defense, such as defending a friendly base camp on urban terrain, as part of a force protection mission. The same techniques of establishing a perimeter defense described above (and in FM 7-10) are used. The company maintains the appropriate level of security (for example, 100 percent, 50 percent, or 30 percent), consistent with the commander's plan and the enemy situation. Additional tasks may include--

- Establish roadblocks and checkpoints.
- Search individuals and vehicles before they enter the camp.
- Maintain a presence as a show of force to the civilian population outside the base camp.
- Conduct inner and outer security patrols.
- Clear urban terrain of any enemy that overwatches the base camp.
- Conduct ambushes to interdict any enemy forces moving toward the base camp.
- Restrict access to locations within the base camp and conduct surveillance of these locations from (or from within) adjacent structures or positions.
- Conduct reaction force duties inside and outside the perimeter of the camp.

CHAPTER 7

TACTICAL ENABLING OPERATIONS

Tactical enabling operations address the combat missions that require unique and special considerations for the antiarmor company (or antiarmor platoon in a light infantry battalion). Fluid operational environments now require antiarmor units to conduct the following type combat operations at a greater frequency and in a more rapid manner than required in times past.

Section I. RECONNAISSANCE

Reconnaissance is any mission undertaken, using visual or other methods of observation, to obtain information regarding the activities and resources of enemy forces or the physical characteristics of a particular area. Successful reconnaissance is a focused collection effort, aimed at gathering timely, accurate information about the enemy and the terrain in the area of operation. It is the responsibility of every commander to conduct reconnaissance with the goal of gaining the information he needs to ensure the success of his mission.

7-1. RECONNAISSANCE PLANNING

Reconnaissance planning starts with the commander's identification of critical information requirements. This process begins while the unit is planning or preparing for an operation and, in many cases, continues during the conduct of the operation. Once the operation is under way, the commander continues to identify information requirements.

7-2. RECONNAISSANCE EXECUTION

A commander develops the situation with active and passive reconnaissance. Passive reconnaissance includes techniques such as map and photographic reconnaissance and surveillance. Active reconnaissance methods available to a commander include mounted ground reconnaissance elements.

7-3. RECONNAISSANCE DURING OPERATIONS

During offensive operations, any reconnaissance effort normally focuses on fighting for information about the enemy and the terrain, with the primary goal of gaining an advantage over the enemy. The information gained by the antiarmor company (or platoon) while in contact is critical not only to the success of its own mission but also to the success of its higher headquarters.

7-4. FORMS OF RECONNAISSANCE

There are three forms of reconnaissance that are conducted as distinct operations: route, zone, and area.

a. **Positioning of Subordinate Elements.** In conducting a route, zone, or area reconnaissance, the antiarmor company commander (or platoon leader) employs mounted and dismounted elements to accomplish his mission. He evaluates the factors of METT-TC and identifies whether the reconnaissance will be oriented on the terrain or on the enemy force. It is essential that he provide his unit with clear guidance on the focus of the reconnaissance. For example, the critical task may be simply to find the enemy and gather

information on him; therefore, terrain considerations of the route, zone, or area are only a secondary concern. The unit generally is able to move more quickly in force-oriented reconnaissance than in terrain-oriented reconnaissance.

b. **Conduct of the Reconnaissance.** The following paragraphs examine the specifics of route, zone, and area reconnaissance.

(1) **Route Reconnaissance.** A route reconnaissance is a directed effort to obtain detailed information on a specific route as well as on all terrain from which the enemy could influence movement along that route. Route reconnaissance may be oriented on a specific area of movement, such as a road or trail, or on a more general area like an axis of advance.

(2) **Zone Reconnaissance.** A zone reconnaissance is a directed effort to obtain detailed information concerning all routes, terrain, enemy forces, and obstacles (including areas of chemical and radiological contamination) within a zone that is defined by specific boundaries. The company normally conducts zone reconnaissance when the enemy situation is vague or when the company requires information concerning cross-country trafficability. As in route reconnaissance, the factors of METT-TC and the brigade and infantry battalion commander's intent dictate the antiarmor unit's actions during a zone reconnaissance.

(a) The following tasks are normally considered critical components of the operation:

- Find and report all enemy forces within the zone.
- Reconnoiter specific terrain within the zone.
- Report all reconnaissance information.

(b) Time permitting, the commander may also direct the antiarmor unit to accomplish the following tasks as part of a zone reconnaissance:

- Reconnoiter all terrain within the zone.
- Inspect and classify all bridges (with engineer augmentation).
- Locate fords or crossing sites near all bridges.
- Inspect and classify all overpasses, underpasses, and culverts (with engineer augmentation).
- Locate and clear all mines, obstacles, and barriers (within capability).
- Locate bypasses around built-up areas, obstacles, and contaminated areas.

(3) **Area Reconnaissance.** Area reconnaissance is a directed effort to obtain detailed information concerning the terrain or enemy activity within a prescribed area. The area can be any location that is critical to the unit's operations. Examples include easily identifiable areas covering a fairly large space (such as towns or military installations), terrain features (such as ridge lines, wood lines, choke points), or a single point (such as a bridge or a building). The critical tasks of the area reconnaissance are the same as those associated with zone reconnaissance.

Section II. SECURITY OPERATIONS

Security operations are conducted to provide early and accurate warning of enemy operations, to provide the protected force with time and maneuver space to react to the enemy, and to develop the situation to allow a commander to employ the protected force effectively. Units may conduct these operations to the front, flanks, or rear of the higher force. (For additional information on security operations, refer to FM 17-95.)

7-5. FORMS OF SECURITY OPERATIONS

The four forms of security operations are screen, cover, guard, and area security. Screen, guard, and cover entail deployment of progressively higher levels of combat power and provide increasing levels of security for the main body. Area security preserves a higher commander's freedom to move his reserves, position fire support assets, conduct command and control operations, and provide for sustainment operations. An antiarmor company can conduct screen operations on its own. It participates in cover, guard, and area security missions only as part of a larger element or with significant augmentation. The light infantry battalion antiarmor platoon, with augmentation, can effectively conduct a screen. It participates in all of these operations as part of a larger element in cover, guard, and area security missions.

NOTE: All forces have an inherent responsibility to provide for their own local security. Local security includes observation posts, local security patrols (mounted and dismounted), perimeter security, and other measures taken to provide close-in security for the force.

7-6. PLANNING CONSIDERATIONS

Security operations require the commander assigning the security mission and the security force leader to address a variety of special operational factors. These planning considerations are described in the following paragraphs.

a. **Augmentation of Security Forces.** When an antiarmor unit conducts a screen, guard, or area security mission, the unit may receive additional combat, CS, and CSS elements. Attachments may include, but are not limited to, the following:

- A reconnaissance platoon or squad.
- A mortar section.
- Associated CSS elements.

b. **Enemy-Related Considerations.** Security operations require the antiarmor unit to deal with a unique set of enemy considerations. For example, the array of enemy forces (and the tactics that enemy commanders use to employ them) may be different from those for any other tactical operation the unit conducts. Additional enemy considerations can influence security operations including, but not limited to, the following:

(1) The presence or absence of specific types of forces on the battlefield, including the following:

- Insurgent elements (not necessarily part of the enemy force).
- Enemy reconnaissance elements of varying strength and capabilities (at divisional, regimental, or other levels).
- Enemy security elements (such as forward patrols).
- Enemy stay-behind elements or enemy elements that have been bypassed.

(2) Possible locations that the enemy will use to employ his tactical assets, including the following:

- Reconnaissance and infiltration routes.
- OP sites for surveillance or indirect fire observers.

(3) Availability and anticipated employment of other enemy assets, including the following:

- Surveillance devices, such as radar devices or UAVs.
- Long-range rocket and artillery assets.
- Helicopter and fixed-wing air strikes.
- Elements capable of infiltration.
- Mechanized forward detachments.

c. **Time the Security Operation is to be Initiated.** The time by which the screen or guard must be set and active influences the unit's method of deploying to the security area as well as the time it begins the deployment.

d. **Reconnaissance of the Security Area.** The antiarmor company commander (or platoon leader) conducts a thorough analysis of the factors of METT-TC to determine the appropriate methods and techniques for the unit to use in accomplishing this critical action.

NOTE: The antiarmor company commander (or platoon leader) must make every effort to conduct his own reconnaissance of the security area that he expects the unit to occupy, even when the operation is preceded by a zone reconnaissance by other battalion elements.

e. **Movement to the Security Area.** In deploying elements to an area for a stationary security mission, the antiarmor company commander (or platoon leader) must deal with the competing requirements of establishing the security operation quickly to meet mission requirements and of providing the necessary level of local security in doing so.

(1) The unit can conduct a tactical road march to a release point (RP) behind the security area to occupy their initial positions. This method of deployment is faster than a movement to contact, but less secure. It is appropriate when enemy contact is not expected or when time is critical.

(2) The antiarmor unit conducts an approach march from the LD to the security area. This method is slower than a tactical road march, but it is more secure. It is appropriate when time is not critical and either enemy contact is likely or the situation is unclear.

f. **Location and Orientation of the Security Area.** The higher commander determines the location, orientation, and depth of the security area in which he wants the security force to operate. The security force commander conducts a detailed analysis of the terrain in the security area. He then establishes his initial dispositions. This is usually a screen line (even for a guard mission) as far forward as possible and on terrain that allows clear observation of avenues of approach into the sector. The initial screen line is depicted as a phase line and sometimes represents the forward line of troops (FLOT). As such, the screen line may be a restrictive control measure for movement. This requires the security force commander to conduct all necessary coordination if he decides to establish observation posts (OPs) or to perform any reconnaissance forward of the FLOT.

g. **Initial OP Locations.** The antiarmor company commander (or platoon leader) may deploy OPs to ensure effective surveillance of the sector or of NAIs. He designates initial OP locations on or behind the screen line. He should assign the OPs with specific orientation and observation guidance, including, at a minimum, the primary orientation for the surveillance effort during the conduct of the screen. Once set on the screen line, the surveillance elements report their locations. The element that occupies each OP always retains the responsibility for changing the location in accordance with tactical requirements and the commander's

intent and guidance for orientation. Dismounted OPs maximize stealth.

h. **Special Requirements and Constraints.** The security force commander must specify any additional considerations for the security operation, including, but not limited to, the following:

- All requirements for observing NAIs, as identified by the battalion or brigade.
- Any additional tactical tasks or missions that the unit must perform.
- Engagement and disengagement criteria for the subordinate elements.

i. **Indirect Fire Planning.** The security force commander conducts indirect fire planning to integrate artillery and mortar assets into the security mission. A wide sector may require him to position mortar assets where they can provide effective coverage of the enemy's most likely axis of attack or infiltration routes, as determined in his analysis of the enemy. The FSO assists him in planning artillery fires to adequately cover any gaps in the mortar coverage.

j. **Positioning of Command and Control and CSS Assets.** The security force commander normally positions himself where he can observe the most dangerous enemy axis of attack or infiltration route, with the XO (or the person identified as second in command) positioned on the second most critical axis or route. The XO positions the company command post (if used) in depth and, normally, centered in sector. This location allows the XO to provide control of initial movement, to receive reports from the screen or guard elements, and to assist the commander in more effectively facilitating command and control. Unit trains are positioned behind masking terrain, but they remain close enough for rapid response. The trains are best sited in depth and along routes that afford good lateral mobility. Patrols may be required to cover gaps between the OPs. The security force commander tasks elements to conduct either mounted or dismounted patrols, as required.

k. **Coordination.** The security force commander must conduct adjacent unit coordination to ensure there are no gaps in the screen or guard and to ensure smooth execution of the unit's rearward passages of lines (if required). Additionally, he must coordinate for the unit's follow-on mission.

l. **CSS Considerations.** The security force commander's primary consideration for CSS during the security operation is coordinating and conducting resupply of the unit, especially for Class III and V supplies. One technique is for the commander to pre-position Class III and Class V vehicles at the unit's successive positions. In addition to normal considerations, however, the security force commander may acquire other responsibilities in this area, such as arranging CSS for a large number of attached elements or coordinating resupply for a subsequent mission. The unit's support planning can be further complicated by a variety of factors. To prevent these factors from creating tactical problems, the unit must receive requested logistical support, such as additional medical evacuation vehicles, from the higher headquarters.

m. **Follow-On Missions.** The complexities of security missions, combined with normal operational requirements (such as troop-leading procedures, engagement area development, rest plans, and CSS activities), can easily rob the security force commander of the time he needs for planning and preparation of follow-on missions. He must address these competing demands in his initial mission analysis to ensure that the unit and its leaders can adequately meet all requirements for current and future operations. If possible, the security force commander can shift his focus to preparing for follow-on missions once preparations for the

security mission are complete (or satisfactorily under way). Another technique is to task the XO, with support personnel and vehicles, to prepare for follow-on missions. The XO and this element can handle such operational requirements as reconnaissance, coordination, and development of follow-on engagement areas and battle positions. The drawback to this technique is that the XO and those with him are unavailable for the current fight.

7-7. SCREEN

A screen primarily provides early warning. It observes, identifies, and reports enemy actions to the main defense. A screen provides the least amount of protection of any security mission. Generally, a screening force fights only in self-defense; however, it may engage enemy reconnaissance elements within its capability. It normally does not have the combat power to develop the situation.

a. **Purposes.** A screen is appropriate to cover gaps between forces, the exposed flanks or rear of stationary and moving forces, or the front of a stationary formation. It is used when the likelihood of enemy contact is remote, the expected enemy force is small, or the friendly main body needs only a minimum amount of time once it is warned to react effectively. Units accomplish a screen primarily by establishing a series of OPs and conducting patrols to ensure adequate surveillance of the assigned sector. Purposes of a screen include the following:

- Prevent enemy ground elements from passing through the screen undetected or unreported.
- Maintain continuous surveillance of all avenues of approach into the sector under all visibility conditions.
- Destroy or repel enemy reconnaissance elements within its capability without violating the commanders' intent.
- Locate the lead elements of each enemy advance guard force and determine their direction of movement.
- Maintain contact with enemy forces and report any activity in sector.
- Impede and harass the enemy within capability while displacing.
- Maintain contact with the enemy main body and any enemy security forces operating on the flanks of friendly forces.

b. **Stationary Screen.** The antiarmor company commander (or platoon leader) assigns surveillance responsibility to the unit's subordinate elements. He designates locations of OPs, which should be in depth through the sector. Antiarmor squads within the unit normally man the OPs. The commander identifies the enemy's likely axes of attack or infiltration routes. If necessary, he identifies additional control measures (such as NAIs, phase lines, TRPs, or checkpoints) to assist in movement control and in tracking of enemy elements. The unit conducts mounted and dismounted patrols to reconnoiter areas that cannot be observed from OPs. Once the enemy is detected from an OP, the screening force may engage him with indirect fires. This prevents the enemy from penetrating the screen line and does not compromise the location of the OP. Within its capability, the screening force may destroy enemy reconnaissance assets with direct fires if indirect fires cannot accomplish the task. The screening force also impedes and harasses other enemy elements, primarily through the use of indirect fires. If enemy pressure threatens the security of the screening force, the unit normally reports the situation and requests permission to displace to a subsequent screen line

or follow-on mission.

c. **Moving Screen.** An antiarmor company (or platoon) can conduct a moving screen to the flanks or rear of the main body force. The movement of the screen is keyed to time and distance factors associated with the movement of the friendly main body.

(1) ***Moving Flank Screen.*** Responsibilities for a moving flank screen begin at the front of the main body's lead combat element and end at the rear of the protected force. In conducting a moving flank screen, the company either occupies a series of temporary OPs along a designated screen line or, if the protected force is moving too fast, continues to move while maintaining surveillance and preparing to occupy a designated screen line. There are four basic methods of controlling movement along the screened flank. The screening force may use one or more of these methods as the speed of movement of the protected force changes or contact is made. The four methods are described in the following paragraphs.

(a) ***Alternate Bounds by Individual OP.*** This method is used when the protected force is advancing slowly and enemy contact is likely along the screen line. Designated elements of the screening force move to and occupy new OPs as dictated by the enemy situation and the movement of the main body. Other elements remain stationary, providing overwatch and surveillance, until the moving elements establish their new positions; these elements then move to new positions while the now-stationary elements provide overwatch and surveillance. This sequence continues as needed. The method of alternate bounding by individual OP is secure but slow.

(b) ***Alternate Bounds by Unit.*** This method is used when the protected force is advancing slowly and enemy contact is likely along the screen line. Designated elements of the screening force move and occupy new positions as dictated by the enemy situation and the movement of the main body. Other elements remain stationary, providing overwatch and surveillance, until the moving elements establish their new positions; these elements then move to new positions while the now-stationary elements provide overwatch and surveillance. This sequence continues as needed. The method of alternate bounding by unit is secure but slow.

(c) ***Successive Bounds.*** The screening element uses this method when the total tactical environment is being developed and enemy contact is possible. During this time, the main body makes frequent short halts during movement. Each subordinate unit of the screening force occupies a designated portion of the screen line each time the main body stops. When main body movement resumes, the subordinate units move simultaneously, retaining their relative position as they move forward.

(d) ***Continuous Marching.*** This method is used when the main body is advancing rapidly at a constant rate and enemy contact is not likely. The screening force maintains the same rate of movement as the main body while at the same time conducting surveillance as necessary. Stationary screen lines are planned along the movement route, but the screening force occupies them only as necessary to respond to enemy action.

(2) ***Moving Rear Screen.*** A moving rear screen may be established to the rear of a main body force conducting an offensive operation or between the enemy and the rear of a force conducting a retrograde operation. In either case, movement of the screen is keyed to the movement of the main body or to the requirements of the enemy situation; the antiarmor company commander (or platoon leader) normally controls the moving rear screen by moving to a series of pre-designated phase lines.

7-8. GUARD

A guard force protects the friendly main body either by fighting to gain time (while simultaneously observing the enemy and reporting pertinent information) or by attacking, defending, or delaying the enemy to prevent him from observing the main body and engaging it with direct fires. There are three types of guard operations (advance, flank, and rear guard). They can be conducted in support of either a stationary or a moving friendly force. The guard force differs from a screening force in that it contains sufficient combat power to defeat, repel, or fix the lead elements of an enemy ground force before they can engage the main body with direct fires. In addition, the guard force normally deploys over a narrower front than does a comparably sized screening force, allowing greater concentration of combat power. The guard force routinely engages enemy forces with both direct and indirect fires (it normally operates within range of the main body's indirect fire weapons).

a. **Purposes.** The purposes of the guard, in addition to those listed in the earlier discussion of the screen, include the following:

- Destroy or repel all enemy reconnaissance elements.
- Fix and defeat enemy security elements.
- Cause the enemy main body to deploy, then report its direction of travel to the friendly main body commander.

b. **Types.** The following paragraphs describe the operational considerations for an antiarmor company conducting advance, flank, or rear guard.

(1) **Advance Guard.** An advance guard for a stationary force is defensive in nature. The antiarmor company defends or delays in accordance with the intent of the higher commander. An advance guard for a moving force is offensive in nature. The antiarmor company normally conducts an offensive advance guard mission during a movement to contact as part of a battalion. Its role is to maintain the freedom of maneuver of the main body by providing early warning of enemy activity and by finding, fixing, and finishing (destroying) enemy reconnaissance and security elements.

(2) **Flank Guard.** A flank guard protects an exposed flank of the main body. A flank guard is similar to a flank screen except that both OPs and defensive positions are planned. The antiarmor company may conduct a moving flank guard during an attack or a movement to contact. In conducting a moving flank guard, the antiarmor company normally occupies a series of pre-designated battle positions along the protected flank. It must maintain orientation both to the front (to perform its overwatch role and to maintain its own security) and to the protected flank. It must also maintain a sufficient distance from the main body to prevent the enemy from engaging the main body with long-range direct fires before early warning can be sent. (Paragraph 7-8d focuses on execution of a moving flank guard.)

(3) **Rear Guard.** The rear guard protects the rear of the main body as well as all CS and CSS elements within the main body. This may occur during offensive operations when the main body breaks contact with the FLOT or during retrograde operations. Rear guards may be deployed behind either moving or stationary main bodies. The rear guard for a moving force displaces to successive battle positions along phase lines as the main body moves. During retrograde operations, the rear guard normally deploys its elements across the entire sector behind the main body's forward maneuver units.

c. **Stationary Guard.** As noted, a stationary guard mission is, at least initially, defensive in nature. The guard force normally employs OPs to accomplish all surveillance

requirements of the guard mission. The antiarmor company must be prepared to conduct actions against the enemy's main body and security elements as well as his reconnaissance forces. The following paragraphs describe considerations for the antiarmor company commander in operations involving specific enemy elements.

(1) **Actions against Main Body and Security Elements.** Once contact is made with an enemy main body or security force, the guard force attacks, defends, or delays in accordance with the enemy situation and the intent of the commander of the protected force (main body). (Chapter 5 of this manual discusses considerations for the defense.)

(2) **Actions against Reconnaissance Elements.** When it must execute counterreconnaissance tasks, the antiarmor company normally task-organizes into surveillance elements (finders) that normally occupy a screen line and attack elements (fighters). Each element has specific responsibilities but must be prepared to work effectively with the other to ensure success of the operation. The antiarmor company commander must assign clear responsibilities for surveillance of identified avenues of approach and designated NAIs. The surveillance element is tasked with detecting, reporting, and maintaining contact with the enemy in the assigned surveillance sector. Figure 7-1 illustrates a company stationary guard operation.

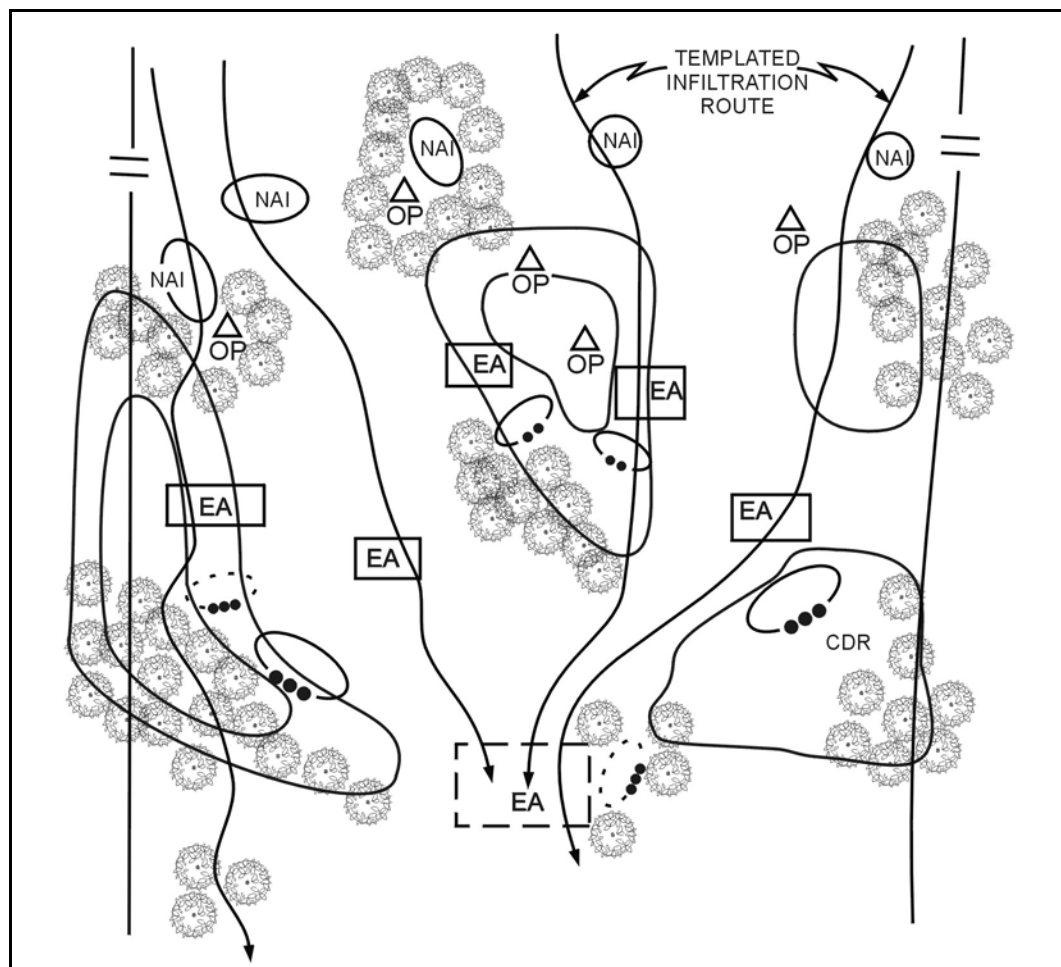

Figure 7-1. Stationary guard with OPs forward.

d. **Moving Flank Guard.** Many of the considerations for a moving flank screen apply to the execution of a moving flank guard. However, unlike a moving flank screen, which occupies a series of OPs, the flank guard force plans to occupy a series of defensive positions. In conducting a moving flank guard, the antiarmor company either occupies a series of temporary battle positions along the protected flank or, if the protected force is moving too quickly, continues to move along the protected flank. During movement, the antiarmor company maintains surveillance to the protected flank of the higher unit while preparing to occupy designated battle positions based on enemy activity or on the movement of the protected force. There are three basic methods of controlling movement along the guarded flank:

- Alternate bounds by unit.
- Successive bounds by unit.
- Continuous marching.

NOTE: These are similar to the methods for controlling movement along a screened flank, except that the antiarmor company and its platoons occupy pre-designated battle positions instead of OPs.

The lead element of a moving flank guard must accomplish three tasks. It must maintain contact with the protected force (main body), reconnoiter the flank guard's axis of advance, and reconnoiter the zone between the protected force and the flank guard's advance. The remainder of the flank guard marches along the axis of advance and occupies battle positions to the protected flank as necessary. Figure 7-2 illustrates an antiarmor company flank guard operation during an SBCT movement to contact. One platoon is employed to provide security to the front and maintain contact with the main body; the other two platoons are oriented to the protected flank. The illustration shows battle positions that the platoons may occupy to respond to the approaching enemy force.

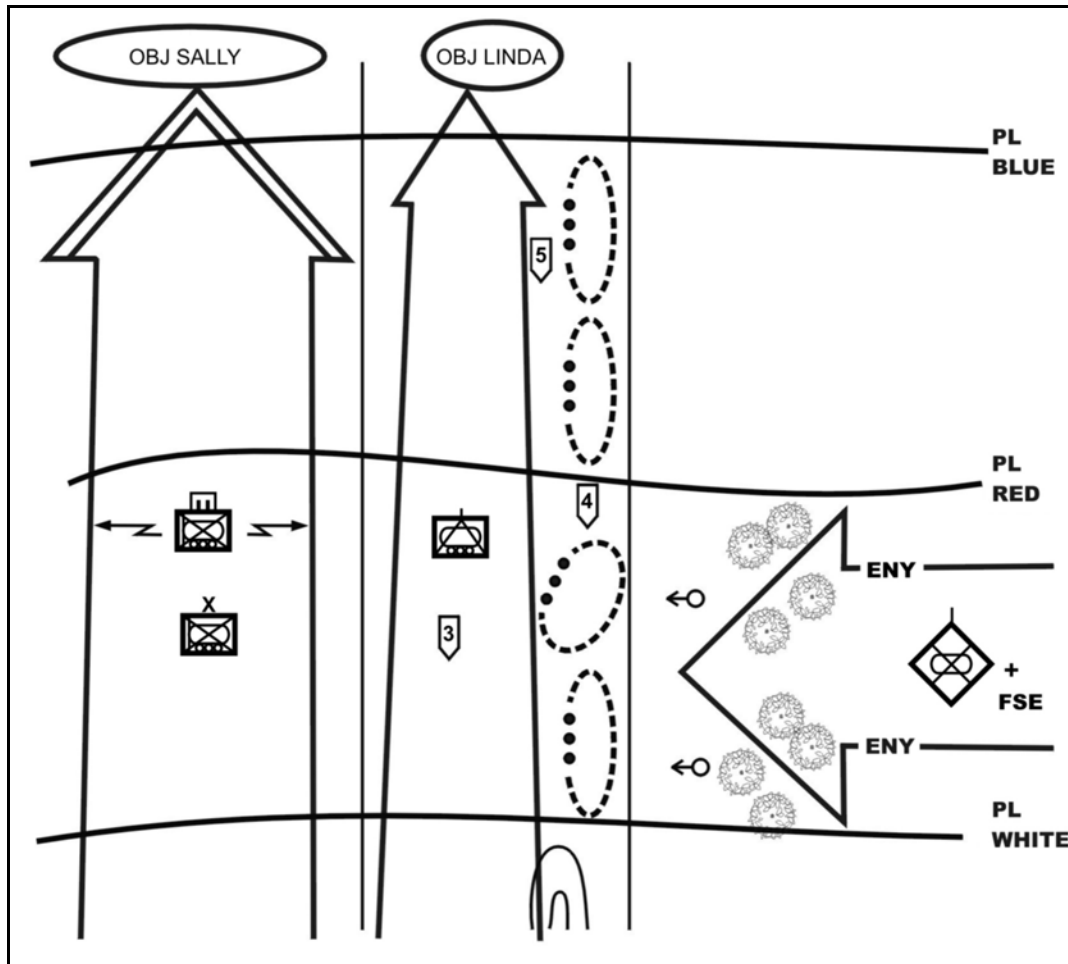

Figure 7-2 Antiarmor company guarding the SBCT flank during movement to contact.

7-9. LOCAL SECURITY

An antiarmor company (or platoon) is responsible for maintaining its own security at all times. It does this by deploying mounted and dismounted OPs and patrols to maintain surveillance and by employing appropriate OPSEC measures. In addition to maintaining security for its own elements, the unit may implement local security, if augmented, for other units as directed by the higher commander. Examples of such situations include, but are not limited to, the following:

- Provide security for engineers as they emplace obstacles or construct survivability positions in the unit's BP.
- Secure pickup zone (PZ) and LZs.
- Establish mounted or dismounted OPs to maintain surveillance of enemy infiltration and reconnaissance routes.
- Conduct mounted or dismounted patrols to cover gaps in observation and to clear possible enemy OPs from surrounding areas.

Section III. LINKUP

Linkup is an operation that entails the meeting of friendly ground forces or their leaders (or designated representatives). An antiarmor company can conduct linkup activities independently or as part of a larger force; however, the antiarmor platoon from the light infantry battalion will conduct linkup activities as a part of a larger force.

7-10. LINKUP SITUATIONS

Linkup may occur in, but is not limited to, the following situations:

- Advancing forces reaching an objective area previously secured by air assault, airborne, or infiltrating forces.
- Units conducting coordination for a relief in place.
- Cross-attached units moving to join their new organization.
- A unit that is moving forward during a follow-and-support mission with a fixing force.
- A unit moving to assist an encircled force.
- Units converging on the same objective during the attack.
- Units conducting a passage of lines.

7-11. LINKUP PLANNING

The plans for a linkup must be detailed and must cover the following items:

a. **Site Selection.** Identify both a primary and an alternate site. These sites should be easy to find at night, have cover and concealment, and be off the natural lines of drift. They also must be easy to defend for a short time and offer access and escape routes.

b. **Recognition Signals.** Far and near signals are needed to keep friendly units from firing on each other. Although the units conducting the linkup exchange radio frequencies and call signs, the radio should be avoided as a means of recognition due to the threat of compromise. Visual and voice recognition signals should be planned.

NOTE: In the SBCT, the antiarmor company may use the FBCB2 display as a means of recognition with other SBCT or similarly equipped units.

(1) Units exchange sign and countersign. This can be a challenge and password or a number combination for a near signal. It also can be an exchange of signals using flashlights, chemical lights, infrared lights, or VS-17 panels for far recognition signals.

(2) Other signals are placed on the linkup site. Examples include stones placed in a prearranged pattern, markings on trees, and arrangements of wood or tree limbs. These mark the exact location of the linkup. The first unit to the linkup site places the sign and positions the contact company to watch it. The next unit to the site then stops at the signal and initiates the far recognition signal.

c. **Indirect Fires.** Indirect fires are always planned. They can support unit movement by masking noise, deceiving the enemy of friendly intent, and distracting the enemy. Plan indirect fires along the infiltration lanes and at the linkup sites to support units linking up in case of enemy contact.

d. **Direct Fires.** Direct fire planning must prevent fratricide. A restrictive fire line (RFL) controls fires around the linkup site. Phase lines may serve as RFLs that are adjusted as two

forces approach each other.

e. **Contingency Plans.** The unit SOP or the linkup annex to the OPORD must cover the following contingencies:

- Enemy contact before linkup.
- Enemy contact during linkup.
- Enemy contact after linkup.
- How long to wait at the linkup site.
- What to do if some elements do not make it to the linkup.
- Alternate linkup points and rally points.

7-12. STEPS OF THE LINKUP OPERATION

In a linkup, the procedure begins as the unit moves to the linkup point. If FM radio is used, the antiarmor unit reports its location using phase lines, checkpoints, or other control measures. Each unit sends a small contact team or element to the linkup point; the remainder of the unit stays in the linkup rally point. The leader fixes individual duties of the contact elements and coordinates procedures for integrating the linkup units into a single linkup rally point. The unit conducts full rehearsals if time permits. Antiarmor companies follow the procedures illustrated in Figure 7-3.

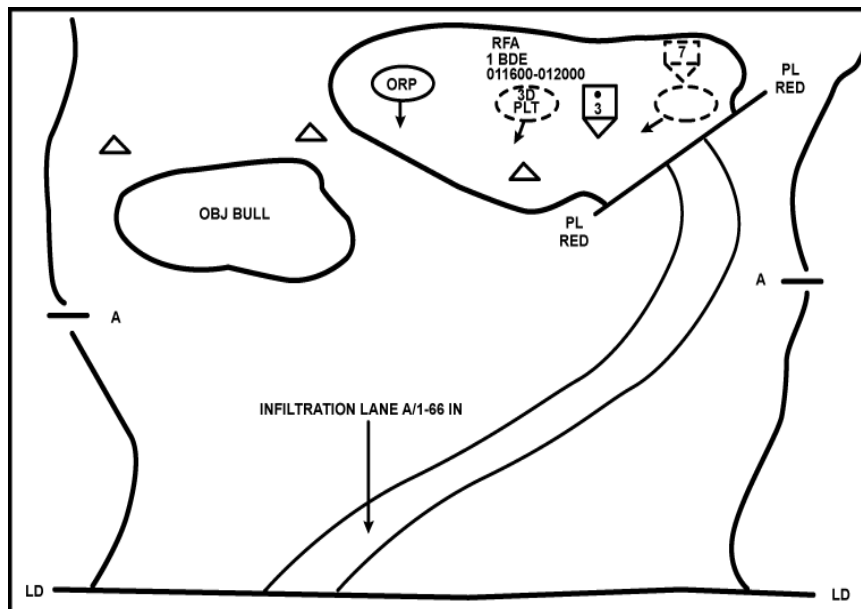

Figure 7-3. Company linkup.

a. The unit stops and sets up a linkup rally point approximately 300 meters (METT-TC dependent) from the linkup point. A contact team is sent to the linkup point; it locates the point and observes the area. If the unit is the first at the site, it clears the immediate area and marks the linkup point, using the agreed-upon recognition signal. It then takes up a covered and concealed position to watch the linkup point.

b. The next unit approaching the site repeats the actions above. When its contact team arrives at the site and spots the recognition signal, it then initiates the far recognition signal,

which is answered by the first unit, and they exchange near recognition signals.

c. The contact teams coordinate the actions required to linkup the units, such as to move one unit to the other unit's rally point, or to continue the mission.

d. The linkup consists of three steps:

(1) ***Far Recognition Signal.*** During this step, if possible, the units or elements involved in the linkup should establish communications before they reach direct fire range. The lead element of each linkup force should operate on the same frequency as the other friendly force.

(2) ***Coordination.*** Before initiating movement to the linkup point, the forces must coordinate necessary tactical information, including the following:

- The known enemy situation.
- Number and types of friendly vehicles (if any).
- Disposition of stationary forces (if either unit is stationary).
- Routes to the linkup point and rally point (if used).
- Fire control measures.
- Near recognition signal(s).
- Communications information.
- CS coverage.
- CSS responsibilities and procedures.
- Finalized location of the linkup point and rally point (if used).
- Any special coordination, such as that covering maneuver instructions or requests for medical support.

(3) ***Movement to the Linkup Point and Linkup.*** All units or elements involved in the linkup must enforce strict fire control measures to help prevent fratricide. Linkup points and RFLs must be easily recognizable by the converging forces. Linkup elements take these actions:

- Conduct far recognition using FM radio or FBCB2.
- Conduct short-range (near) recognition using the designated signal.
- Complete movement to the linkup point.
- Establish local security at the linkup point.
- Conduct additional coordination and linkup activities as necessary.

Section IV. PASSAGE OF LINES

A passage of lines entails movement of one or more units through another unit. This operation becomes necessary when the moving unit(s) cannot bypass the stationary unit and must pass through it. The primary purpose of the passage is to maintain the momentum of the moving elements. A passage of lines may be designated as either forward or rearward. (Refer to the discussion and illustrations later in this section.) The controlling higher headquarters is responsible for planning and coordinating a passage of lines. In some situations, as when an antiarmor company is using multiple passage routes (such as a separate route for each subordinate unit), the company commander must take responsibility for coordinating each step with the stationary unit.

7-13. PLANNING CONSIDERATIONS

In planning the passage of lines, the higher commander must consider the tactical factors and procedures covered in the following paragraphs.

a. **Passage Lanes.** The passage should facilitate transition to follow-on missions through the use of multiple lanes or lanes wide enough to support doctrinal formations for the passing units.

b. **Use of Deception.** The unit can use deception techniques, such as smoke, to enhance security during the passage.

c. **Battle Handover.** The controlling higher commander must clearly define the battle handover criteria and procedures to be used during the passage. His order should cover the roles of both the passing unit and the stationary unit and the use of direct and indirect fires. He also specifies the location of the battle handover line (BHL) as part of the unit's graphic control measures. For a forward passage, the BHL is normally the LD for the passing force; in a rearward passage, it is normally a location within the direct fire range of the stationary force. In general, a defensive handover is complete when the passing unit is clear and the stationary unit is ready to engage the enemy. Offensive handover is complete when the passing unit has deployed and crossed the BHL (LD).

d. **Obstacles.** The passing and stationary units must coordinate obstacle information to include the locations of enemy and friendly obstacles, existing lanes and bypasses, and guides for the passage.

e. **Air Defense.** Air defense coverage is imperative during the high-risk passage operation. The stationary unit normally is responsible for providing air defense, allowing the passing unit's air defense assets to move with it.

f. **CSS Responsibilities.** Responsibility for CSS actions, such as vehicle recovery or casualty evacuation in the passage lane, must be defined clearly for both passing and stationary units.

g. **Command and Control.** To enhance command and control during the passage, the antiarmor company (or platoon leader) collocates a command and control element with a similar element from the stationary or moving unit (as applicable).

7-14. RECONNAISSANCE COORDINATION

Detailed reconnaissance and coordination are critical in a passage of lines, both in dealing with the often complex planning factors outlined previously and in ensuring that the passage is conducted quickly and efficiently. The antiarmor company commander (or platoon leader) normally conducts all necessary reconnaissance and coordination for the passage. At times, he may designate another leader to conduct liaison duties for reconnaissance and coordination. The following items of information are coordinated:

- Unit designation and composition; type and number of passing vehicles.
- Passing unit arrival time(s).
- Location of attack positions or assembly areas.
- Current enemy situation.
- Stationary unit's mission and plan (to include OP, patrol, and obstacle locations).
- Location of movement routes, contact points, passage points, and passage lanes.
- Guide requirements.
- Order of march.

- Anticipated actions on enemy contact.
- Requirements for supporting direct and indirect fires, including the location of the RFL.
- NBC conditions.
- Available CS and CSS assets and their locations.
- Communications information (to include frequencies, digital data, and near and far recognition signals).
- Criteria for battle handover and location of the BHL.
- Additional procedures for the passage.

NOTE: In units with FBCB2, the use of GPS and or position navigation (POSNAV) waypoints simplifies this process and, as a result, may speed the passage.

7-15. FORWARD PASSAGE OF LINES

In a forward passage of lines, the passing unit first moves to an assembly area or an attack position behind the stationary unit. Designated liaison personnel move forward to linkup with guides and confirm coordination information with the stationary unit. Guides then lead the passing elements through the passage lane. The antiarmor unit conducts a forward passage by employing tactical movement. It moves quickly, using appropriate dispersion and movement formations whenever possible and keeping FM radio transmission to a minimum. It bypasses disabled vehicles as necessary. The unit holds its fire until it passes the BHL or designated fire control measure unless the liaison personnel have coordinated direct fire control with the stationary unit. Once clear of passage lane restrictions, the unit consolidates (at a rally point or attack position, if necessary) and conducts tactical movement in accordance with its orders. Figure 7-4 illustrates a forward passage of lines.

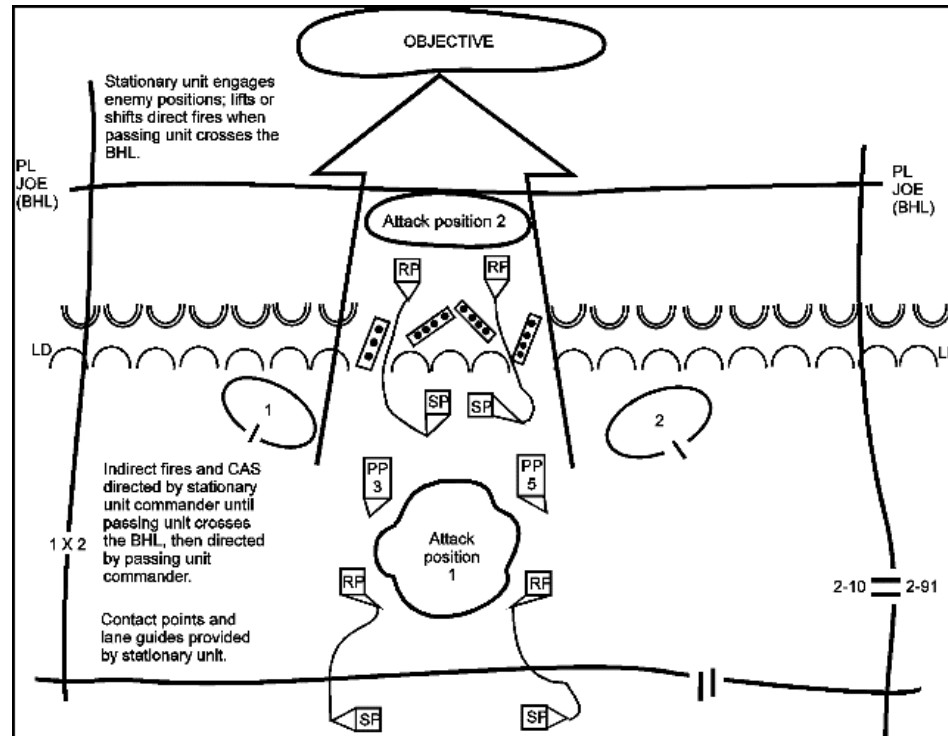

Figure 7-4. Company forward passage of lines.

7-16. REARWARD PASSAGE OF LINES

Because of the increased chance of fratricide during a rearward passage of lines, coordination of recognition signals and direct fire restrictions is critical. The passing unit contacts the stationary unit while it is still beyond direct fire range and conducts coordination via FM radio (or FCB2, if equipped). Near recognition signals and location of the BHL are emphasized. Additional fire control measures, such as RFLs, may be employed to further minimize the risk of fratricide. Following coordination, the passing unit continues tactical movement toward the passage lane. Weapons systems are oriented on the enemy, and the passing unit is responsible for its own security until it passes the BHL. If the stationary unit provides guides, the passing unit may conduct a short halt to linkup and coordinate with them. The passing unit moves quickly through the passage lane to a designated location behind the stationary unit (Figure 7-5, page 7-18).

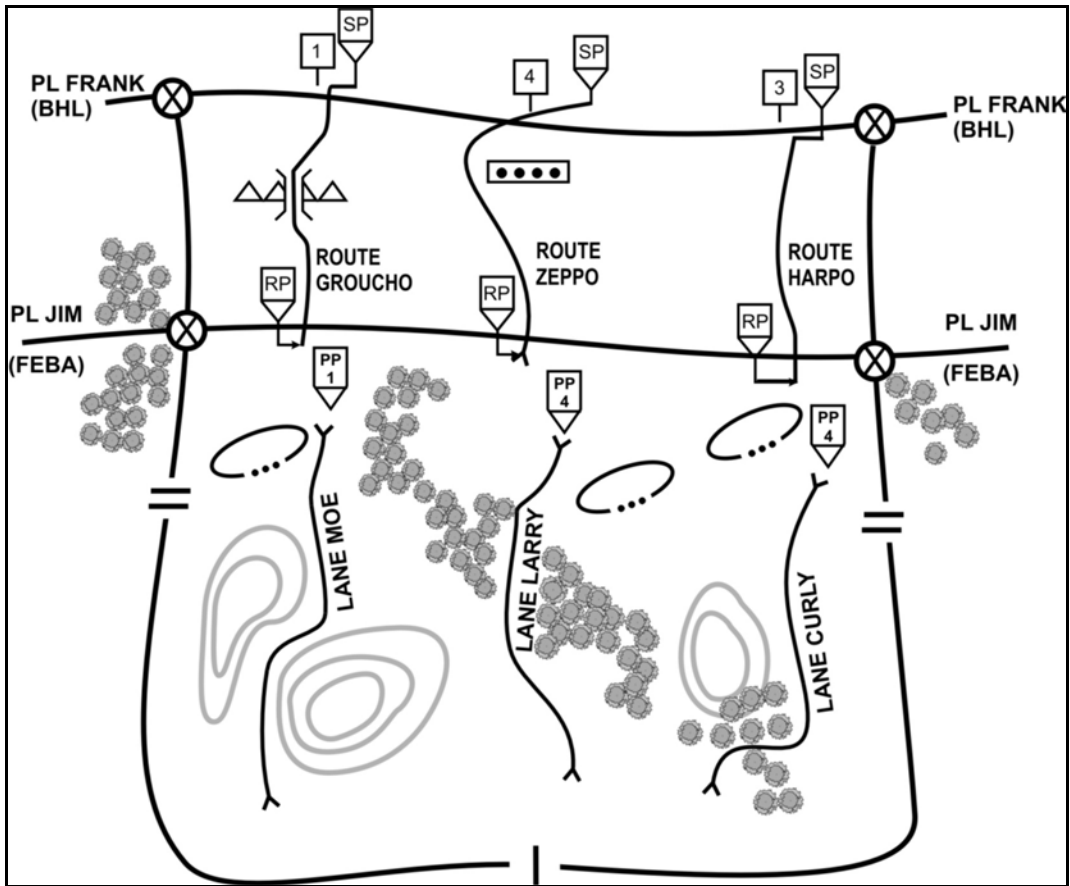

Figure 7-5. Company rearward passage of lines.

CHAPTER 8

STABILITY OPERATIONS

Stability operations encompass a range of actions that shape the political environment and respond to developing crises. These operations are diverse, continuous, and often long-term. Stability operations may include both developmental and coercive actions. Developmental actions are aimed at enhancing a government's willingness and ability to care for its people. Coercive military actions involve the application of limited, carefully prescribed force, or the threat of force, to achieve specific objectives. Stability operations are usually nonlinear and noncontiguous and often are time and manpower intensive. Army elements may be tasked to conduct stability operations in a complex, dynamic, and often unconventional (or asymmetric) environment to accomplish one or more of the following purposes:

- *Deter or thwart aggression.*
- *Reassure allies or friendly governments, agencies, or groups.*
- *Provide encouragement and support for a weak or faltering government.*
- *Stabilize an area with a restless or openly hostile population.*
- *Maintain or restore order.*
- *Satisfy treaty obligations or enforce national or international agreements and policies.*

Section I. PRINCIPLES OF STABILITY OPERATIONS

Planning for stability operations follows the procedures described in FM 5-0. The principles of objective, unity of command, economy of force, and security offer checks on the contents of all plans; the other principles of war may apply to stability operations in special circumstances. Simple concepts of operation, a clear commander's intent, and well-understood tasks, responsibilities, and priorities are as important in stability operations as they are in any other operation.

NOTE: For more detailed information on stability operations, refer to FM 3-0, FM 3-07, and FM 3-07.3.

8-1. OBJECTIVE

Direct every military operation toward a clearly defined, decisive, and attainable objective. A clearly defined and attainable objective--with a precise understanding of what constitutes success--is critical when US forces are involved in stability operations. Commanders should understand specific conditions that could result in mission failure as well as those that mark success. They must understand the strategic aims of the mission, set appropriate objectives, and ensure these aims and objectives contribute to unity of effort with other agencies.

8-2. UNITY OF EFFORT

Seek unity of effort in every operation. This principle is derived from the principle of war directing US forces to retain unity of command within their contingents. Unity of effort emphasizes the need for directing all means to a common purpose. However, the numbers of nonmilitary participants (non-governmental organizations [NGOs] and private volunteer organizations [PVOs]) complicates achieving unity of effort during stability operations. Whenever possible, commanders should seek to establish a control structure that takes into account and provides coherence to the activities of all elements in the area. This requirement necessitates reliable communications and extensive liaison with all involved parties. Because stability operations often involve small-unit activities, all levels of command must understand the military-civilian relationship to avoid friction.

8-3. SECURITY

Never permit hostile factions to acquire an unexpected advantage. In stability operations, security deals with force protection as a dynamic of combat power against virtually any person, element, or hostile group. These could include terrorists, a group opposed to the operation, criminals, and even looters.

a. In stability operations, commanders should not assume that the non-hostile intent of their mission protects their force. The inherent right of self-defense, from unit to individual level, applies at all times in stability operations.

b. Security, however, requires more than physical protective measures. A force can significantly enhance its security through perceived legitimacy and impartiality, the mutual respect built between the force and the other parties involved in stability operations, and the force's credibility in the international arena. In stability operations, security involves demonstrations of inherent military capability and preparedness.

8-4. RESTRAINT

Apply appropriate military capability prudently. Restraints on weaponry, tactics, and levels of violence characterize the environment of stability operations. The use of excessive force may adversely affect efforts to gain or maintain legitimacy and impede the attainment of both short-term and long-term goals. ROE that are established by the tactical controlling headquarters for the operation should clearly spell out these restraints. ROE do not preclude the application of sufficient or overwhelming force when required to protect US or indigenous lives. When used, force should be precise to reduce friendly and noncombatant casualties and collateral damage. Precision and high-technology weaponry help reduce casualties.

8-5. PERSEVERANCE

Prepare for the measured, sustained application of military capability in support of strategic aims. While some stability operations may be of short duration, most require long-term commitments that involve more than military efforts alone. Underlying causes of confrontation and conflict rarely have a clear beginning or a decisive resolution. Commanders need to assess each action in terms of its contribution to long-term strategic objectives. Perseverance requires an information strategy that clearly explains the goals, objectives, and desired end states and links them with US interests and concerns. This

effort should continually emphasize the long-term nature of many stability operations without giving the impression of permanency.

8-6. LEGITIMACY

Sustain the people's willing acceptance of the right of the government to govern or a group or agency to make and carry out decisions. Commanders must be aware of the authority under which they operate and the relationship between it and the other sources of legitimacy that are present. During operations where a clearly legitimate government does not exist, using extreme caution in dealing with individuals and organizations can help prevent inadvertently legitimizing them. The conduct of information operations, to include public affairs, civil affairs (CA), and psychological operations (PSYOP) programs, can enhance both domestic and international perceptions of the legitimacy of an operation.

Section II. TYPES OF STABILITY OPERATIONS

Stability operations typically fall into ten broad types that are neither discrete nor mutually exclusive. For example, a force engaged in a peace operation may also find itself conducting arms control or a show of force to set the conditions for achieving an end state. This section provides an introductory discussion of stability operations; for more detailed information, refer to FM 3-0 and FM 3-07. Types of support operations include--

- Peace operations.
 - Peacekeeping.
 - Peace building.
 - Operations in support of diplomatic efforts.
- Foreign internal defense.
- Security assistance.
- Humanitarian and civic assistance.
- Support to insurgencies.
- Support to counterdrug operations.
- Combating terrorism.
- Noncombatant evacuation operations.
- Arms control.
- Show of force.

8-7. PEACE OPERATIONS

Peace operations encompass three general areas: operations in support of diplomatic efforts, peacekeeping, and peace enforcement. The antiarmor company (or platoon), as part of a larger force, may participate in peacekeeping or peace enforcement operations.

a. **Peacekeeping Operations.** A peacekeeping force monitors and facilitates the implementation of cease-fires, truce negotiations, and other such agreements. In doing so, it must assure all sides in the dispute that the other involved parties are not taking advantage of settlement terms for their own benefit. An antiarmor company most often observes, monitors, or supervises and assists the parties involved in the dispute. The peacekeeping force must remain entirely neutral. If it loses its reputation for impartiality, its usefulness within the peacekeeping mission is compromised.

b. **Peace Enforcement Operations.** Several unique characteristics distinguish peace enforcement activities from wartime operations and from other stability operations. The purpose of peace enforcement is to compel compliance with resolutions or sanctions and to maintain or restore peace and order. It may entail combat, armed intervention, or physical threat of armed intervention. Under the provisions of an international agreement, the battalion (or SBCT) and its subordinate units may be called upon to use coercive military power to compel compliance with international sanctions or resolutions.

c. **Operations in Support of Diplomatic Efforts.** Forces may conduct operations in support of diplomatic efforts to establish peace and order before, during, or after a conflict. These operations include preventive diplomacy, peacemaking, and peace building. Military support of diplomatic activities improves the chances for success by lending credibility to diplomatic actions and demonstrating resolve to achieve viable political settlements.

(1) **Preventive Diplomacy.** Preventive diplomacy is diplomatic action taken in advance of a predictable crisis to prevent or limit violence. Army forces normally are not involved directly in preventive diplomacy but may support a state department effort by providing transportation and communication assets. In some cases, military forces may conduct a preventive deployment or show of force as part of the overall effort to deter conflict.

(2) **Peacemaking.** Peacemaking is the process of diplomacy, mediation, negotiation, or other forms of peaceful settlement that arranges an end to a dispute and resolves the issue that led to the conflict (FM 3-07). Peacemaking includes military actions that support the diplomatic process. Army forces participate in these operations primarily by performing military-to-military contacts, exercises, peacetime deployments, and security assistance. Peacemaking operations also serve to influence important regional and host nation political and military groups.

(3) **Peace Building.** Peace building consists of post-conflict actions, predominately diplomatic and economic, that strengthen and rebuild governmental infrastructure and institutions in order to avoid a relapse into conflict (FM 3-07). Military actions that support peace building are designed to identify, restore, and support structures that strengthen and solidify peace. Typical peace-building activities include restoring civil authority, rebuilding physical infrastructure, providing structures and training for schools and hospitals, and helping to reestablish commerce. When executing peace-building operations, Army forces complement the efforts of nonmilitary agencies and local governments. Many of the actions that support peace building also are performed in long term foreign internal defense (FID) operations.

8-8. FOREIGN INTERNAL DEFENSE

Foreign internal defense is participation by civilian and military agencies of a government in any action programs taken by another government to free and protect its society from subversion, lawlessness, and insurgency (FM 3-07). The main objective is to promote stability by helping a host nation establish and maintain institutions and facilities responsive to its people's needs. Army forces in FID normally advise and assist host-nation forces conducting operations to increase their capabilities.

a. **Types of Support.** When conducting foreign internal defense, Army forces provide indirect support, direct support, military supplies, military advice, tactical and

technical training, and intelligence and logistics to support a host nation's efforts. Generally, US forces do not engage in combat operations as part of an FID. However, on rare occasions when the threat to US interests is great and indirect means are insufficient, US combat operations may be directed to support a host nation's efforts.

b. **Antiarmor Company's Role.** The company's primary roles in nation assistance operations usually are similar to its roles in peace-building operations. If involved in these operations, the company normally will participate as part of a larger force and will most likely be a force provider rather than lead the effort themselves.

8-9. SECURITY ASSISTANCE

Army forces support security assistance efforts by training, advising, and assisting allied and friendly armed forces. Security assistance includes the participation of Army forces in any of a group of programs by which the US provides defense articles, military training, and other defense-related services to foreign nations by grant, loan, credit, or cash sales in furtherance of national policies and objectives (FM 3-07).

8-10. HUMANITARIAN AND CIVIC ASSISTANCE

Humanitarian and civic assistance (HCA) programs provide assistance to the host nation populace in conjunction with military operations and exercises. In contrast to humanitarian and disaster relief operations, HCA programs are planned activities, and they are limited to the following categories:

- Medical, dental, and veterinary care provided in rural areas of a country.
- Construction of rudimentary surface transportation systems.
- Well drilling and construction of basic sanitation facilities.
- Rudimentary construction and repair of public facilities.

8-11. SUPPORT TO INSURGENCIES

This type of support includes assistance provided by US forces to help a friendly nation or group that is attempting to combat insurgent elements or to stage an insurgency itself. The US Army's special operating forces normally conduct this type of stability activity.

8-12. SUPPORT TO COUNTERDRUG OPERATIONS

US military forces may be tasked for a variety of counterdrug activities that are always conducted in conjunction with another government agency. These activities include destroying illicit drugs and disrupting or interdicting drug manufacturing, growing, processing, and smuggling operations. Counterdrug support may take the form of advisory personnel, mobile training teams, offshore training activities, and assistance in logistics, communications, and surveillance.

8-13. COMBATING TERRORISM

Terrorism is the calculated use of unlawful violence or threat of unlawful violence to inculcate fear, intended to coerce or intimidate governments or societies in pursuit of goals that are generally political, religious, or ideological (FM 3-07). Enemies who cannot compete with Army forces conventionally often turn to terrorism. Terrorist attacks often create a disproportionate effect on even the most capable of conventional forces. Army forces conduct operations to defeat these attacks. The company uses offensive

operations to counter terrorism and defensive measures to conduct antiterrorism operations. The tactics employed by terrorists include, but are not limited to, the following:

- Arson.
- Hijacking.
- Maiming.
- Seizure.
- Assassination.
- Hostage taking.
- Sabotage.
- Hoaxes.
- Bombing.
- Kidnapping.
- Raids and ambushes.
- Use of NBC.

a. **Counterterrorism.** Counterterrorism refers to offensive measures taken to prevent, deter, and respond to terrorism (FM 3-07). Army forces participate in the full array of counterterrorism actions, including strikes and raids against terrorist organizations and facilities. Counterterrorism is a specified mission for selected special operations forces (SOF) that operate under direct control of the national command authorities or under a unified command arrangement. The company may participate in battalion or higher level controlled small-unit raids against terrorist forces in support of counterterrorism operations.

b. **Antiterrorism.** Antiterrorism includes defensive measures used to reduce the vulnerability of individuals and property to terrorist attacks, including limited response and containment by local military forces (FM 3-07). Antiterrorism is always a mission consideration and a component of force protection. Antiterrorism must be a priority for all forces during all operations--offensive, defensive, stability, and support. The unit may be a high priority target for terrorists because of the notoriety and media attention that follows an attack on an American target. Commanders must take the security measures necessary to accomplish the mission by protecting the force against terrorism. Typical antiterrorism actions include--

- Coordination with local law enforcement.
- Siting and hardening of facilities.
- Physical security actions designed to prevent unauthorized access or approach to facilities.
- Crime prevention and physical security actions that prevent theft of weapons, munitions, identification cards, and other materials.
- Policies regarding travel, size of convoys, breaking of routines, host nation interaction, and off-duty restrictions.
- Protection from weapons of mass destruction.

8-14. NONCOMBATANT EVACUATION OPERATIONS

A noncombatant evacuation operation (NEO) is conducted primarily to evacuate US citizens whose lives are in danger, although it also may include natives of the host nation

and third-country nationals. These operations involve swift insertion and temporary occupation of an objective followed by a planned withdrawal. Leaders use only the amount of force required for protection of evacuees and self-defense.

8-15. ARMS CONTROL

Arms control operations are normally conducted to support arms control treaties and enforcement agencies. Forces may conduct arms control during combat or stability operations to prevent escalation of the conflict and reduce instability. This could include the mandated disarming of belligerents as part of a peace operation. The collection, storing, and destruction of conventional munitions and weapons systems can deter belligerents from reinitiating hostilities. The unit may be required to conduct or participate in arms control while conducting checkpoint operations and patrols by controlling, seizing, and destroying weapons. Arms control assists in force protection and increases security for the local populace.

8-16. SHOW OF FORCE OPERATIONS

A show of force is an operation designed to demonstrate US resolve and involves increased visibility of US-deployed forces in an attempt to defuse a specific situation that, if allowed to continue, may be detrimental to US interests or national objectives (FM 3-07). The company may participate in a show of force by participating in a temporary buildup in a specific region, conducting a combined training exercise, or demonstrating an increased level of readiness. Although actual combat is not desired, a show of force can escalate rapidly and unexpectedly. The US conducts shows of force for three principal reasons: to bolster and reassure allies, to deter potential aggressors, and to gain or increase influence.

Section III. PLANNING CONSIDERATIONS

Although stability operations normally are centrally planned, execution often takes the form of small-scale, noncontiguous actions conducted over extended distances. Responsibility for making decisions on the ground falls to junior leaders. The following paragraphs examine several important considerations that influence planning and preparation for stability operations. (For a more detailed discussion of these subjects, refer to FM 3-07.3.)

8-17. RULES OF ENGAGEMENT

In decentralized operations, effective command guidance and a detailed understanding of the ROE are critical at every level.

a. ROE are directives that explain the circumstances and limitations under which US forces initiate and continue combat engagement with forces encountered. These rules reflect the requirements of the laws of war, operational concerns, and political considerations when the operational environment shifts from peace to conflict and back to peace.

b. ROE must be briefed and trained to the lowest level. They should be established for, disseminated to, and thoroughly understood by every soldier in the unit. Another important consideration in development and employment of ROE is that commanders must assume that the belligerents they encounter will also understand the ROE. These

unfriendly elements will attempt to use their understanding of the ROE to their own advantage and to the disadvantage of the friendly force. (Refer to FM 3-07 for a more detailed discussion of ROE.)

8-18. RULES OF INTERACTION

Rules of interaction embody the human dimension of stability operations. They lay the foundation for successful relationships with the myriad of factions and individuals that play critical roles in these operations. ROI encompass an array of interpersonal communication skills, such as persuasion and negotiation.

a. ROI are tools the individual soldier needs to deal with the nontraditional (or asymmetric) threats that are prevalent in stability operations, including political friction, unfamiliar cultures, and conflicting religious ideologies and rituals. In turn, ROI enhance the soldier's survivability in such situations.

b. ROI are based on the applicable ROE for a particular operation; they must be tailored to the specific regions, cultures, and populations affected by the operation.

c. Reinforcement of ROI is critical. ROI can be effective only if they are thoroughly rehearsed and understood by every soldier in the unit.

8-19. FORCE PROTECTION

Antiarmor company commanders (or platoon leaders) must implement appropriate security measures to protect the force. Establishment of checkpoints, effective base camp security procedures, and aggressive patrolling are examples of force protection measures. The antiarmor company (or platoon) may receive taskings as part of the higher headquarters' security plan. Additional security taskings result from the commander's concept for the defense. These taskings may be oriented on friendly units (screen, guard, or secure), on the enemy and terrain (reconnaissance), or on the enemy's reconnaissance assets (counterreconnaissance). The antiarmor company commander (or platoon leader) establishes a security plan to keep the enemy from observing or surprising the unit. He establishes this plan before moving the unit into the area and maintains it continuously. The antiarmor company commander (or platoon leader) bases this plan on tasks received from the higher headquarters and on an analysis of the factors of METT-TC. The plan provides active and passive measures and counterreconnaissance.

a. **Active Measures.** These include establishing OPs, conducting stand-to, and conducting patrols.

(1) The antiarmor company commander (or platoon leader) can require each subordinate unit to have a set number of OPs; if not, the subordinate leaders decide what they need. As a guide, there should be at least one OP for each platoon.

(2) The commander (or platoon leader) can also require a set quantity of men and weapon systems to be on security at all times. The quantity varies based on an analysis of the factors of METT-TC. As a guide, at least one third of the soldiers should be on security at all times.

(3) When an attack is expected, the entire unit should be on alert; however, this should not be maintained for long periods. The commander (or platoon leader) must keep in mind that his soldiers need rest to function in future operations. A sleep plan must be established and enforced. Security, however, cannot be sacrificed for rest.

(4) A stand-to is held both morning and evening to ensure that each man adjusts to the changing light and noise conditions and is dressed, equipped, and ready for action. The stand-to should start before first light in the morning and continue until after light. It should start before dark in the evening and last until after dark. The starting and ending times should vary to prevent establishing a pattern, but the stand-to must last long enough to accomplish its purpose.

(5) The higher headquarters can have its subordinate units dispatch patrols whose missions contribute to the higher unit's security. The company commander can dispatch patrols in addition to those required by the higher headquarters to satisfy the security needs. He may have the patrols reconnoiter dead space in the company sector, gaps between platoons, gaps between the company and adjacent units, or open flanks. Antiarmor platoons in light infantry battalions may dispatch security patrols as part of the higher unit's security plan. All patrols sent out must be coordinated with the higher headquarters.

b. Passive Measures. These measures include camouflage, movement control, light and noise discipline, and proper radiotelephone procedures. The company's weapons systems (TOW, M2, and MK19), with their daysights and nightsights, can add to the security effort both day and night. The company should also use other night vision devices to compliment the surveillance plan.

(1) To ensure effective coverage, a commander may direct antiarmor platoons to cover specific areas with specific devices (such as thermal sights). He may also specify how many night vision devices will be in use (for example, "one half of the soldiers on security will use night vision devices").

(2) Sector sketches should include the locations of key weapon systems and the type of sight being employed.

8-20. TASK ORGANIZATION

Because of the unique demands of stability operations, an antiarmor unit often is task-organized to operate with a variety of other elements that it might not otherwise operate with in offensive or defensive operations. These include: linguists/interpreters, military attorneys, political advisors, counterintelligence teams, and civil affairs teams.

8-21. CSS CONSIDERATIONS

The operational environment an antiarmor unit faces during stability operations may be very austere, creating special CSS considerations. These factors include, but are not limited to, the following:

- Reliance on local procurement of certain items.
- Shortages of various critical items, including repair parts, Class IV supply materials, and Class III lubricants.
- Special Class V supply requirements for non-lethal weapons.
- Difficulty in finding or obtaining potable water, resulting in reliance on bottled water.

8-22. MEDIA CONSIDERATIONS

The presence of the media is a reality that confronts every soldier, especially when involved in stability operations. All leaders and soldiers must know how to deal

effectively with broadcast and print reporters and photographers. Leaders and soldiers must always tell the truth; however, they should understand which subjects they are authorized to discuss and which subjects they must refer to the public affairs officer (PAO). They must talk about what they know and not what they may speculate.

8-23. OPERATIONS WITH OUTSIDE AGENCIES

US Army units may conduct certain stability operations in coordination with a variety of outside organizations. These include other US armed services or government agencies as well as international organizations such as PVOs, NGOs, and United Nations (UN) military forces or agencies.

Section IV. COMPANY TASKS

Stability operations are complex and very demanding. Antiarmor units participating in stability operations must master skills ranging from conducting negotiations to establishing observation posts and checkpoints or conducting a convoy escort. The tasks discussed in this section include lessons learned that will assist the antiarmor company commander and platoon leaders in implementing these and other tasks. The light infantry battalion's antiarmor platoon or its subordinate elements will most likely be task-organized to an infantry company conducting many of these same tasks.

8-24. ESTABLISH AND OCCUPY A LODGMENT AREA

A lodgment area is a highly prepared position used as a base of operations for force projection in stability operations (Figure 8-1). Like an assembly area or defensive strongpoint, the lodgment provides a staging area for the occupying unit, affords a degree of force protection, and requires 360-degree security. However, several important characteristics distinguish the lodgment area from less permanent positions.

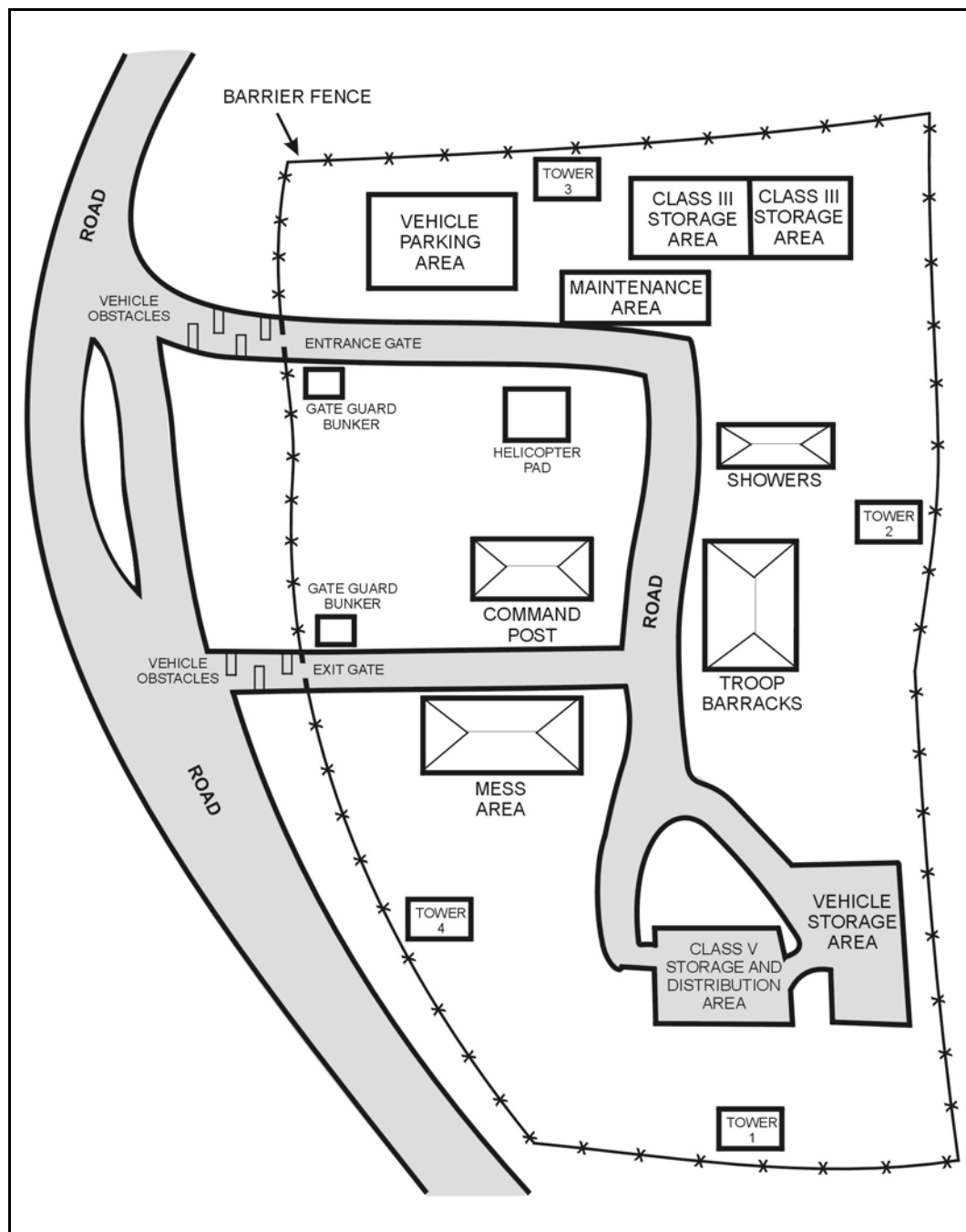

Figure 8-1. Example company lodgment area using existing facilities.

a. **Long Term Occupation.** Due to the probability of long-term occupation, the lodgment requires a high level of preparation and logistical support. It must have shelters and facilities that can support the occupying force and its attachments for an extended period. The area must be positioned and developed so the unit can effectively conduct its primary missions (such as peace enforcement) throughout its area of responsibility.

b. **Use of Existing Facilities.** In establishing the lodgment area, the company may use existing facilities or request construction of new facilities. A key advantage in using existing structures is immediate availability, and this also reduces or eliminates the need

for construction support from engineers and other members of the company. There are disadvantages as well. Existing facilities may be inadequate to meet the company's operational needs, and they may pose security problems because of their proximity to other structures.

c. **Participation as Part of Larger Unit.** The company may establish and occupy a lodgment area as part of a battalion or as a separate element (with significant support from the controlling battalion).

d. **General Layout of Lodgment.** Before he begins preparation, construction, and occupation of the lodgment area, the antiarmor company commander must plan its general layout. He should evaluate the following factors:

- (1) Location of the lodgment area.
- (2) Effects of weather.
- (3) Local traffic patterns.
- (4) OP sites and patrol routes.
- (5) Entry and exit procedures.
- (6) Vehicle emplacement and orientation.
- (7) Bunkers and fighting positions.
- (8) Direct and indirect fire planning.
- (9) Size and composition of the reserve.
- (10) Location of possible LZs and PZs.
- (11) CSS considerations, including locations of the following:
 - Mess areas, showers, and latrines (including drainage).
 - Storage bunkers for Class III, IV, and V supplies.
 - Maintenance and refueling areas.
 - Aid station.
 - CP site security.
- (12) Size, composition, and function of advance and reconnaissance parties.
- (13) Nature and condition of existing facilities (such as quarters, water, sewer, and power utilities and reinforced "hard-stand" areas for maintenance).
- (14) Proximity to structures and roadways (including security factors).
- (15) Priorities of work. The commander must designate priorities of work as the company establishes the lodgment area. He should consider the following tasks:
 - Establishment of security of the immediate area and the perimeter.
 - Establishment of initial roadblocks to limit access to the area.
 - Mine clearance.
 - Construction of revetments to protect vehicles, generators, communications equipment, and other facilities.
 - Construction of barriers or berms around the lodgment area to limit observation of the compound and provide protection for occupants.
 - Construction of shelters for lodgment personnel.
 - Construction of defensive positions.
 - Construction of sanitation and personal hygiene facilities.
 - Construction of hardened CP facilities.
 - Continuing activities to improve the site (such as adding hard-wire electrical power or perimeter illumination).

8-25. NEGOTIATIONS

The antiarmor company may face a number of situations in which leaders need to conduct negotiations. There are two general types of negotiations: situational and preplanned.

a. **Situational Negotiations.** Situational negotiations are conducted in response to a requirement for on-the-spot discussion and resolution of a specific issue or problem. An example would be members of an advance guard negotiating the passage of a convoy through a checkpoint. At the company level, situational negotiations are far more common than the preplanned type.

(1) **Working Knowledge.** Employment in stability operations requires the commander, his subordinate leaders, and other soldiers to conduct some form of negotiations almost daily. This, in turn, requires them to have a thorough understanding of the commander's intent, ROE, and ROI. Members of the company apply this working knowledge to the process of discussing and, whenever possible, resolving issues and problems that arise between opposing parties, which may include the unit itself. A critical aspect of this knowledge is the negotiator's ability to recognize that he has exhausted his options under the ROE and ROI and must turn the discussion over to a higher authority. Negotiations continue at progressive levels of authority until the issue is resolved.

(2) **Preparation.** In preparing themselves and their soldiers for the negotiation process, the commander and subordinate leaders must conduct rehearsals covering the ROE and ROI. One effective technique is to rehearse application of ROE and ROI in a given stability situation, such as manning a checkpoint. This rehearsal forces both leaders and subordinates to analyze the ROE and ROI while applying them in an operational environment.

b. **Preplanned Negotiations.** Preplanned negotiations are conducted in response to a requirement for discussion and resolution of an upcoming specific issue or problem. One example of preplanned negotiations is one conducted in situations such as an antiarmor company commander conducting a work coordination meeting between leaders of the belligerents to determine mine clearance responsibilities. Preplanned negotiations require negotiators to thoroughly understand both the dispute or issue at hand and the factors influencing it, such as the ROE and ROI, before talks begin. The negotiator's ultimate goal is to reach an agreement that is acceptable to both sides and that reduces antagonism and the chance of renewed hostilities between the parties involved. The following paragraphs list guidelines and procedures for each step of the preplanned negotiation process.

(1) **Identify the Purpose of Negotiations.** Before contacting leaders of the belligerent parties to initiate the negotiation process, the commander must familiarize himself with both the situation and the area in which his unit will operate. This includes identifying and evaluating avenues of approach that connect the opposing forces. Results of the negotiation process, which may be lengthy and complicated, must be based on national or international agreements or accords. Negotiation topics may include the following:

- When the belligerent sides will withdraw.
- Positions to which they will withdraw (these should preclude observation and direct fire by the opposing parties).
- What forces or elements move during each step of an operation.
- Pre-positioning of forces that can intervene in case of renewed hostilities.

- Control of heavy weapons.
- Mine clearance.
- Formal protest procedures for the belligerent parties.

(2) ***Establish the Proper Context.*** The commander must earn the trust and confidence of each opposing party. This includes establishing an atmosphere (and a physical setting) that participants will judge to be impartial and safe. These considerations apply:

- Always conduct joint negotiations on matters that affect both parties.
- When serving as a mediator, remain neutral at all times.
- Learn as much as possible about the belligerents, the details of the dispute or issue being negotiated, and other factors such as the geography of the area and specific limitations or restrictions (for example, the ROE and ROI).
- Gain and keep the trust of the opposing parties by being firm, impartial, and polite.
- Use tact, remain patient, and be objective.
- Never deviate from the applicable local and national laws and international agreements.

(3) ***Prepare for the Negotiations.*** Thorough, exacting preparation is another important factor in ensuring the success of the negotiation process. Company personnel should use the following guidelines:

- Negotiate sequentially, from subordinate level to senior level.
- Select and prepare a meeting place that is acceptable to all parties.
- Arrange for interpreters and adequate communications facilities as necessary.
- Ensure that all opposing parties, as well as the negotiating company commander, use a common map (edition and scale).
- Coordinate all necessary movement.
- Establish local security.
- Keep higher headquarters informed throughout preparation and during the negotiations.
- Make arrangements to record the negotiations (use audio or video recording equipment, if available).

(4) ***Conduct the Negotiations.*** Negotiators must always strive to maintain control of the session. They must be firm, yet evenhanded, in leading the discussion. At the same time, they must be flexible, with a willingness to accept recommendations from the opposing parties and from their own assistants and advisors. The following procedures and guidelines apply:

- Exchange greetings.
- Introduce all participants by name, including negotiators and any advisors.
- Consider, if warranted, the use of small talk at the beginning of the session to put the participants at ease.
- Allow each side to state its case without interruption and without making premature judgments.
- Make a record of issues presented by both sides.
- If one side makes a statement that is incorrect, be prepared to produce evidence or proof to establish the facts.

- If the negotiating team or peacekeeping force has a preferred solution, present it and encourage both sides to accept it.
- Close the meeting by explaining to both sides what has been agreed upon and what actions they are expected to take. If necessary, be prepared to present this information in writing for their signatures.
- Do not negotiate or make deals in the presence of the media.
- Maintain the highest standards of conduct at all times.

8-26. MONITOR COMPLIANCE WITH AN AGREEMENT

Compliance monitoring involves observing belligerents and working with them to ensure they meet the conditions of one or more applicable agreements. Examples of the process include overseeing the separation of opposing combat elements, the withdrawal of heavy weapons from a sector, or the clearance of a minefield. Planning for compliance monitoring should cover, but is not limited to, the following considerations:

- Assign liaison teams, with suitable communications and transportation assets, to the headquarters of the opposing sides. Liaison personnel maintain communications with the leaders of their assigned element; they also talk directly to each other and to their mutual commander (the antiarmor company or battalion commander).
- Position the company commander at the point where violations are most likely to occur.
- Position platoons and squads where they can observe the opposing parties with instructions to assess compliance and report any violations.
- As directed, keep higher headquarters informed of all developments, including the company commander's assessment of compliance and noncompliance.

8-27. ESTABLISH OBSERVATION POSTS

Construction and manning of OPs may be a task the antiarmor company and subordinate elements execute when they must establish area security during stability operations. Each OP is established for a specified time and purpose. During most stability operations, OPs are overt (conspicuously visible, unlike their tactical counterparts) and deliberately constructed. Each OP must be integrated into supporting direct and indirect fire plans and into the overall observation plan. Based on an analysis of the factors of METT-TC, deliberate OPs may include specialized facilities such as the following:

- Observation towers.
- Ammunition and fuel storage areas.
- Power sources.
- Supporting helipads.
- Kitchens, sleep areas, showers, and toilets.

OPs are similar in construction to bunkers (see FM 5-103) and are supported by fighting positions, barriers, and patrols (Figure 8-2, page 6-16).

NOTE: If necessary, the company can also employ hasty OPs, which are similar to individual fighting positions.

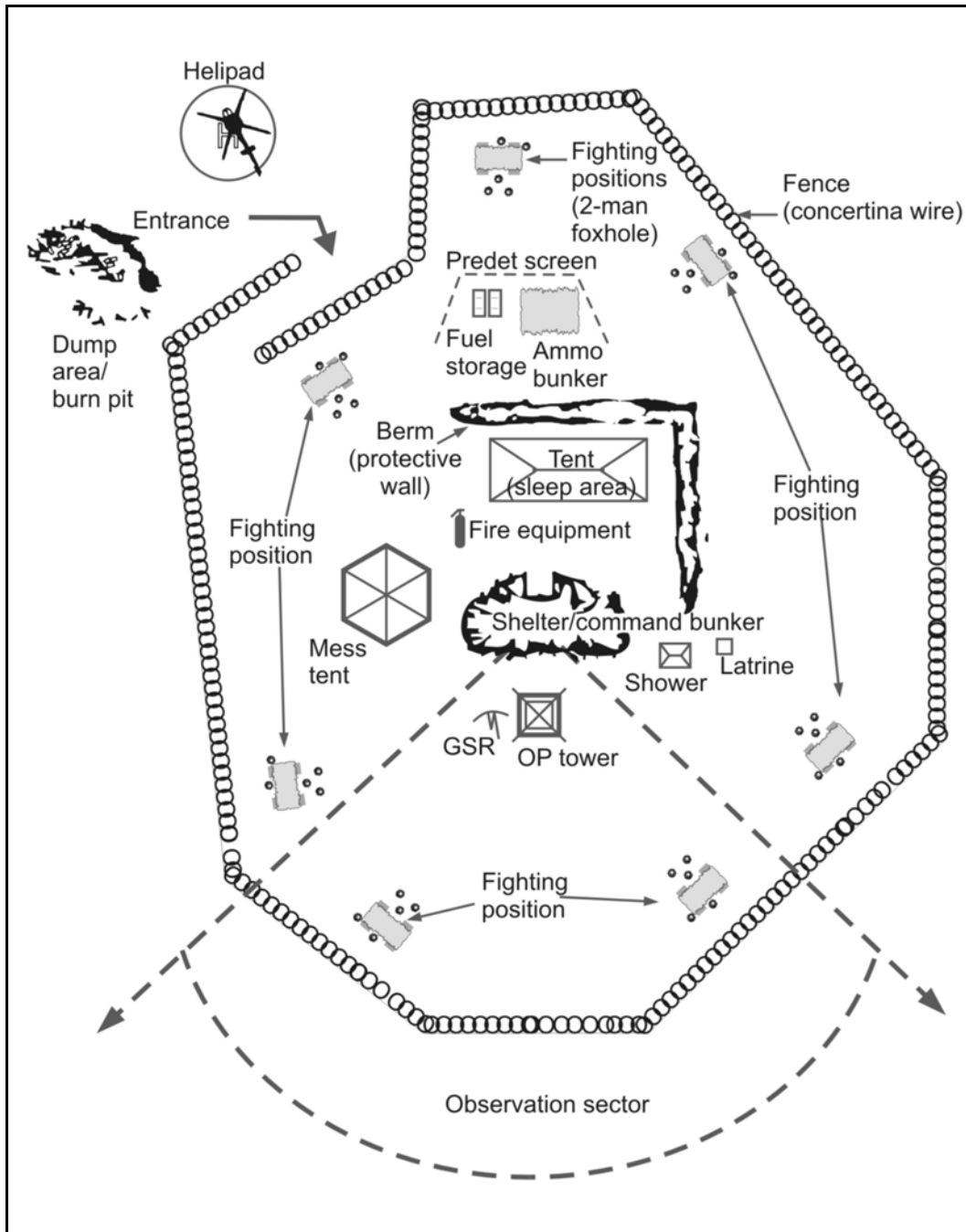

Figure 8-2. Example of a deliberate observation post.

8-28. ESTABLISH CHECKPOINTS

Establishment of checkpoints is a high-frequency task for an antiarmor company and its subordinate elements involved in stability operations. Checkpoints can be either deliberate or hasty.

a. **Purposes.** The antiarmor company or a subordinate element may be directed to establish a checkpoint to achieve one or more of the following purposes:

- Deter illegal movement.
- Create an instant roadblock.
- Control movement into the area of operations or onto a specific route.
- Demonstrate the presence of stability forces.
- Prevent smuggling of contraband.
- Enforce the terms of peace agreements.
- Serve as an OP, patrol base, or both.

b. **Checkpoint Procedures.** Checkpoint layout, construction, and manning should reflect a thorough analysis of the factors of METT-TC (Figure 8-3, page 8-18). The following procedures and considerations may apply:

(1) Position the checkpoint where it is visible and where traffic cannot turn back, get off the road, or bypass the checkpoint without being observed.

(2) Position a combat vehicle (HMMWV or ATGM) off the road, but within sight, to deter resistance to soldiers manning the checkpoint. The vehicle should be in a hull-down position and protected by local security. It must be able to engage vehicles attempting to break through or bypass the checkpoint with the mounted weapon system (more than likely M2 or MK19).

(3) Place obstacles in the road to slow or canalize traffic into the search area.

(4) Establish a reserve if applicable.

(5) Establish a bypass lane for approved convoy traffic.

(6) Establish wire communications within the checkpoint area to connect the checkpoint bunker, combat vehicle, search area, security forces, rest area, and any other elements involved in the operation.

(7) Designate the search area. If possible, it should be below ground to provide protection against such incidents as the explosion of a booby-trapped vehicle. Establish a parking area adjacent to the search area.

(8) If applicable, checkpoint personnel should include linguists/interpreters.

(9) Properly construct and equip the checkpoint. Consider inclusion of the following items:

- Barrels filled with sand, concrete, or water (emplaced to slow and canalize vehicles).
- Concertina wire (emplaced to control movement around the checkpoint).
- Secure facilities for radio and wire communications with the controlling headquarters.
- First-aid kit.
- Sandbags for defensive positions.
- Wood or other materials for the checkpoint bunker.
- Binoculars, night vision devices, and flashlights.
- Long-handled mirrors (used to inspect vehicle undercarriages).

(10) Elements manning a deliberate checkpoint may require access to specialized equipment, such as the following:

- Floodlights.
- Duty logs.
- Flags and unit signs.

- Barrier poles that can be raised and lowered.
- Generators with electric wire.

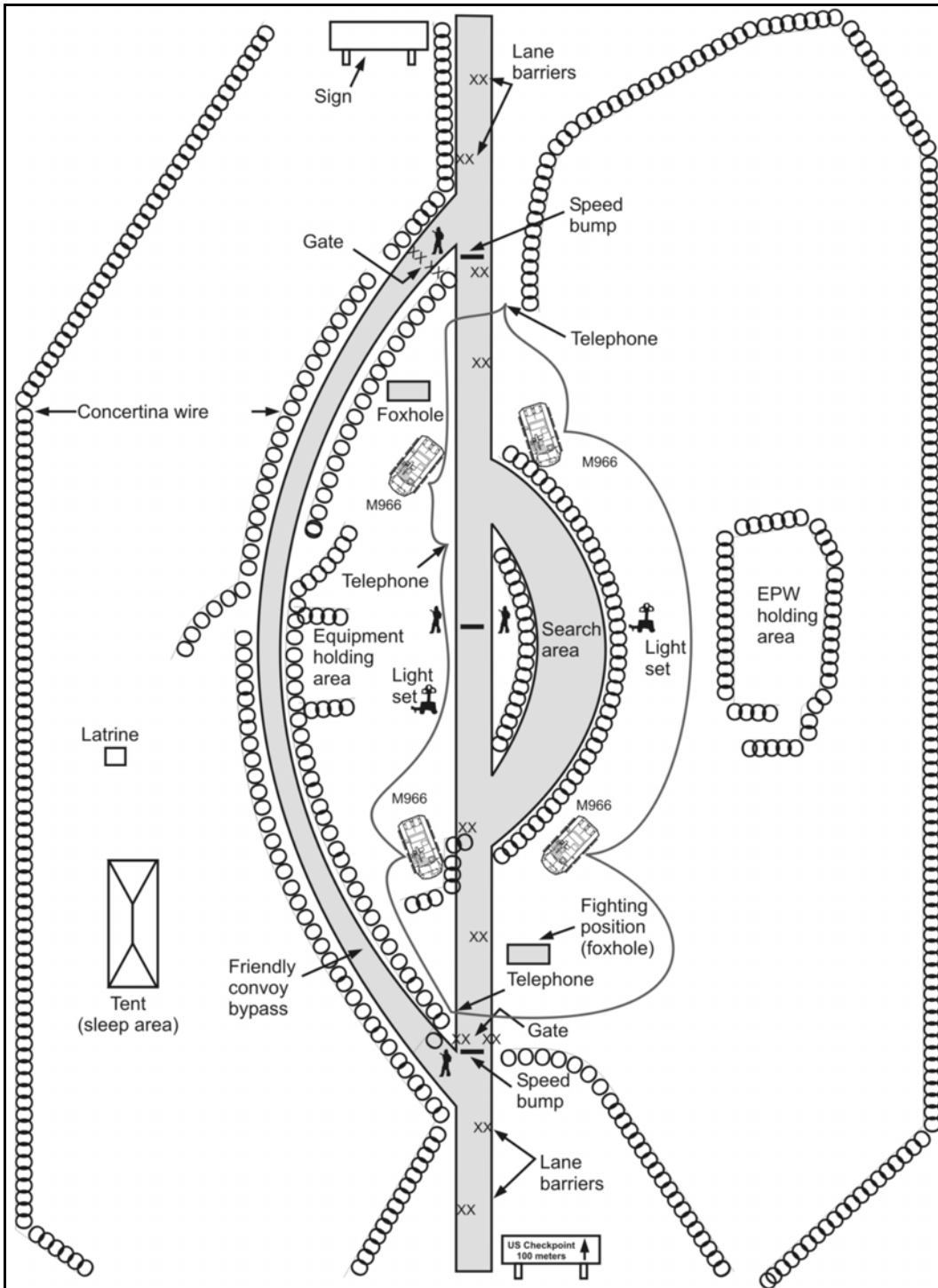

Figure 8-3. Checkpoint layout.

8-29. CONDUCT PATROL OPERATIONS

Patrolling is also a high-frequency task during stability operations. Planning and execution of an area security patrol are similar to procedures for other tactical patrols except that antiarmor company and platoon patrol leaders must consider political implications and ROE. Figure 8-4 illustrates the use of patrols, in conjunction with checkpoints and OPs, in enforcing a zone of separation between belligerent forces.

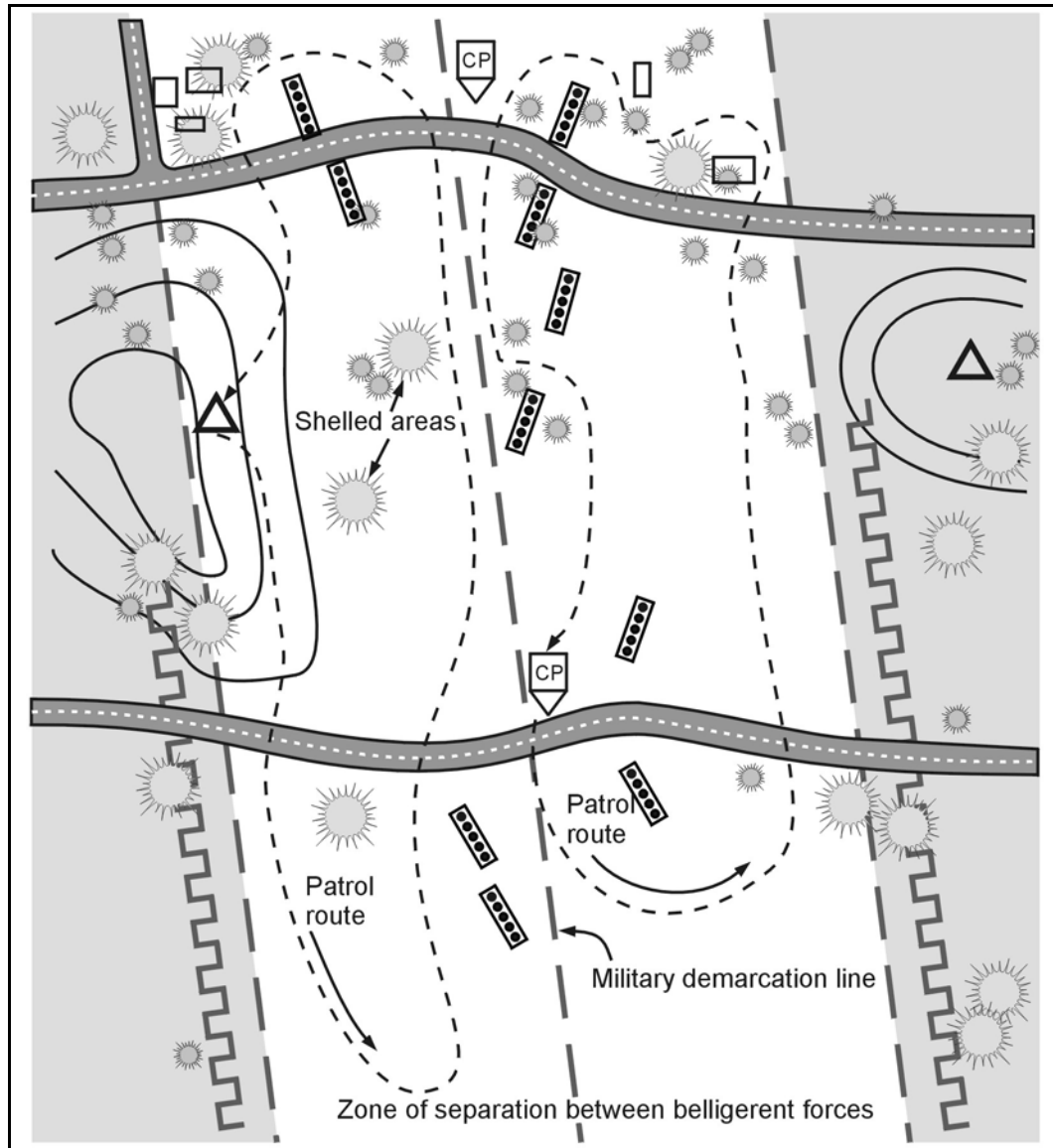

Figure 8-4. Employment of checkpoints, OPs, and patrols to enforce a zone of separation.

8-30. CONDUCT CONVOY ESCORT

This mission requires the antiarmor company (or platoon) to provide a convoy with security and close-in protection from direct fire while on the move (Figure 8-5, page 8-20). The higher headquarters may choose this course of action if contact is imminent or when it anticipates a serious threat to the security of the convoy. The antiarmor company,

with augmentation (for example, military police, infantry platoons, MGS), is capable of providing effective protection for a large convoy. Lighter security forces such as military police units or pure antiarmor platoons may conduct smaller-scale convoy escort missions.

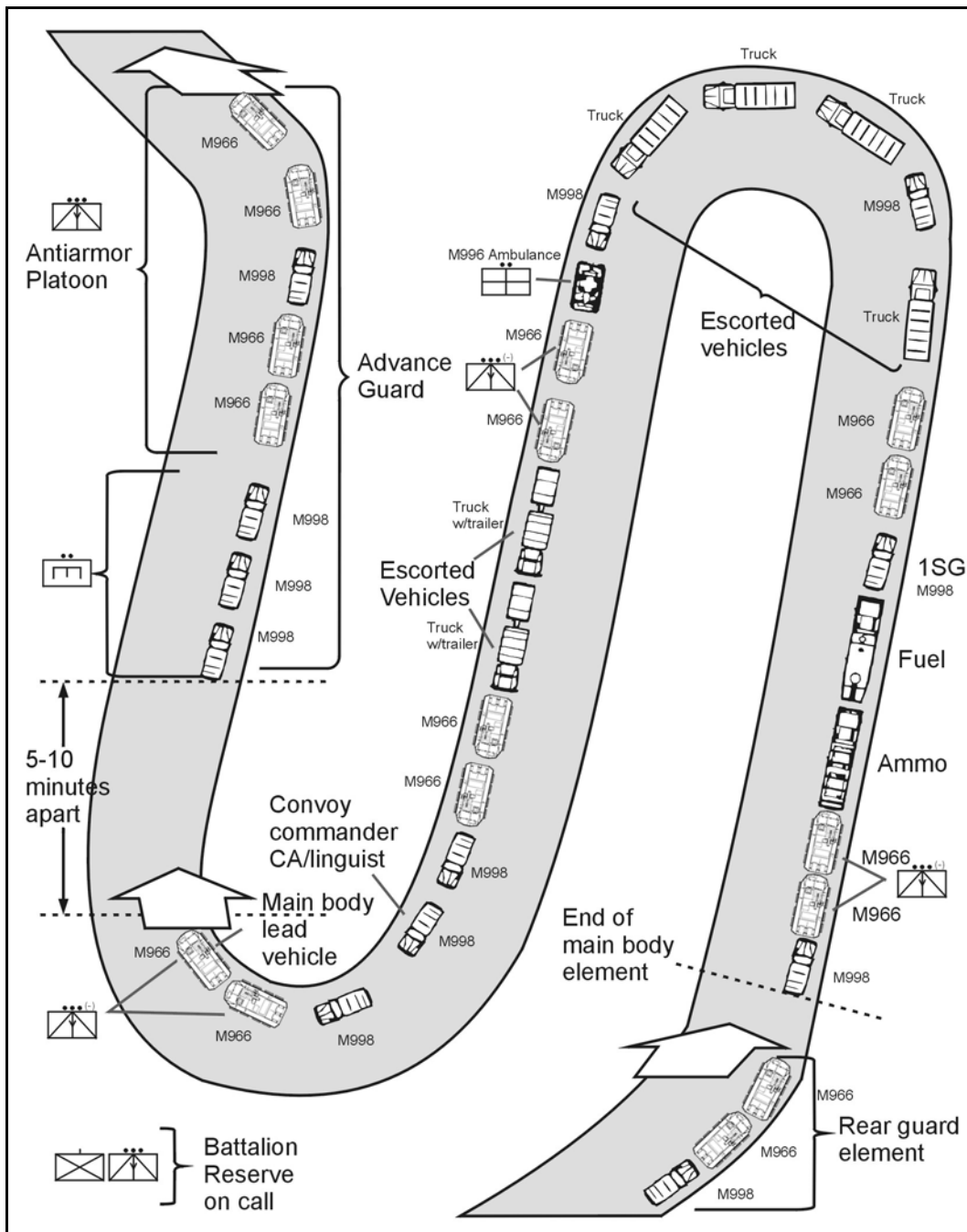

Figure 8-5. A task-organized antiarmor company convoy escort mission.

a. **Command and Control.** The task organization inherent in convoy escort missions makes battle command especially critical. The antiarmor company commander may serve either as the convoy security commander or as overall convoy commander. In

the latter role, he is responsible for the employment not only of his own organic combat elements but also of CS and CSS attachments and drivers of the escorted vehicles. He must incorporate all these elements into the various contingency plans developed for the operation. He must also maintain his communication link with the controlling higher headquarters.

(1) Effective SOPs and battle drills must supplement OPORD information for the convoy, and the antiarmor company should conduct rehearsals if time permits. Additionally, the company should conduct extensive PCCs and PCIs, to include inspection of the escorted vehicles. The company commander must also ensure that the company conducts all required coordination with units and elements in areas through which the convoy will pass.

(2) Before the mission begins, the convoy commander should issue a complete OPORD to all vehicle commanders in the convoy. This is vital because the convoy may itself be task-organized from a variety of units and some vehicles may not have tactical radios. The order should follow the standard five-paragraph OPORD format; however, it may place special emphasis on these subjects:

- Inspection of convoy vehicles.
- Route of march (including a strip map for each vehicle commander).
- Order of march.
- Actions at halts (scheduled and unscheduled).
- Actions in case of vehicle breakdown.
- Actions for a break in column.
- Actions in built-up areas.
- Actions on contact, covering such situations as snipers, near or far ambush, indirect fire, and minefields.
- Riot drill.
- Refugee control drill.
- Evacuation drill.
- Actions at the delivery site.
- Chain of command.
- Guidelines and procedures for negotiating with local authorities.
- Communications and signal information.
- Tactical disposition.

(3) In any escort operation, the basic mission of the convoy commander (and, as applicable, the convoy security commander) is to establish and maintain security in all directions and throughout the length of the convoy. He must be prepared to adjust the disposition of the security force to fit the security requirements of each particular situation. An analysis of the factors of METT-TC, specifically the convoy's size, composition, and organization, affects this disposition. In some instances, the commander may position security elements, such as platoons, to the front, rear, and or flanks of the convoy. As an alternative, he may disperse the combat vehicles throughout the convoy body.

b. **Task Organization.** When sufficient escort assets are available, the convoy commander usually organizes convoy security into three distinct elements: advance guard, close-in protective group, and rear guard. Upon appropriate augmentation, the

commander may also designate an additional reserve in the rear guard to handle contingency situations. The following paragraphs examine the role of the advance guard, security assets accompanying the convoy main body, and the reserve in the rear guard.

NOTE: The convoy escort is provided with linguists and interpreters as required.

(1) **Advance Guard.** The advance guard reconnoiters and proofs the convoy route. It searches for signs of threatening activity, such as ambushes and obstacles. Within its capabilities, it attempts to clear the route. The distance and time separation between the advance guard and the main body should be sufficient to provide the convoy commander with adequate early warning before the arrival of the vehicle column. This separation should be short enough, however, to ensure that the route cannot be interdicted between the passage of the advance guard and the arrival of the main body. The advance guard should be task-organized with both reconnaissance and mobility assets. As necessary, it should also include linguists.

(2) **Main Body.** The commander may choose to intersperse security elements with the vehicles of the convoy main body. These may include combat elements (including the rear guard), the convoy commander, his linguist/interpreter, mobility assets, and medical and maintenance support assets. The convoy commander also may consider the employment of flank security after conducting a thorough analysis of the factors of METT-TC.

(3) **Rear Guard.** The rear guard serves as a reserve and either moves with the convoy or locates at a staging area close enough to provide immediate interdiction against a threatening force. The supporting headquarters normally designates an additional reserve, consisting of an additional company or combat aviation assets, to support the convoy.

c. **Actions on Contact.** As the convoy moves to its new location, the threatening force may attempt to harass or destroy it. This contact usually occurs in the form of an ambush, often executed in coordination with the use of a hasty obstacle. In such a situation, the safety of the convoy rests on the speed and effectiveness with which escort elements can execute appropriate actions on contact. A portion of the convoy security force, such as (based on task organization) an antiarmor or infantry platoon or section, may be designated as a reaction force. This element performs its normal escort duties, such as conducting tactical movement or occupying an assembly area, as required until contact occurs; it then performs a react-to-contact mission when ordered by the convoy commander.

(1) **Actions at an Ambush.** An ambush is one of the most effective ways to interdict a convoy. Reaction to an ambush must be immediate, overwhelming, and decisive. Actions on contact in response to an ambush must be planned for and rehearsed so they can be executed as a drill by all escort and convoy elements, with particular attention given to fratricide prevention. In almost all situations the security force takes several specific, instantaneous actions in reacting to an ambush. These steps include the following:

(a) As soon as they acquire an ambushing force, the escort vehicles immediately return fire in the direction of the attack and attempt to clear the kill zone quickly. They seek covered positions between the convoy and the threatening force and continue to fire in the direction of the attack. The convoy commander sends a contact report to the higher headquarters as quickly as possible.

(b) Convoy vehicles, if armed, may return fire only if the security force has not positioned itself between the convoy and the attacking force.

(c) The convoy commander retains control of the convoy vehicles and continues to move them along the route as quickly as possible.

(d) Subordinate leaders or the convoy commander may request that any damaged or disabled vehicles be abandoned and pushed off the route.

(e) The convoy escort leader uses situation reports to keep the convoy security commander informed. If necessary, the convoy commander can then direct the reserve force from the rear guard or the staging area to take action; he should also call for and adjust indirect fires.

(f) Once the convoy is clear of the kill zone, the convoy escort element executes one of the following COAs based on the composition of the escort and reaction forces, the commander's intent, and the strength of the threatening force:

- Continue to return fire as the reserve moves forward to provide support.
- Break contact and move out of the kill zone.
- Assault the threatening force.

(2) **Actions at an Obstacle.** Obstacles are obstructions that prevent advancing movement. They include, but are not limited to, deliberate roadblocks, disabled vehicles, and large groups of demonstrators. Obstacles pose a major threat to convoy security and can canalize or stop the convoy to set up an ambush. The purpose of route reconnaissance ahead of a convoy is to identify obstacles and either breach them or find bypasses. In some cases, however, the threatening force or its obstacles may avoid detection by the reconnaissance element. If this happens, the convoy must take actions to reduce or bypass the obstacle.

(a) When an obstacle is identified, the convoy escort faces two problems: reducing or bypassing the obstacle and maintaining protection for the convoy. Security becomes critical, and actions at the obstacle must be accomplished very quickly. The convoy commander must assume that the obstacle is overwatched and covered by direct and indirect fires.

(b) To reduce the time the convoy is halted, thus reducing its vulnerability, these actions should occur when the convoy escort encounters point-type obstacles:

- The advance guard element identifies the obstacle, and the convoy commander directs the convoy to make a short halt and establishes security. The convoy escort element overwatches the obstacle and requests to the convoy commander that the breach force moves forward.
- The escort maintains 360-degree security and provides overwatch as the breach force reconnoiters the obstacle in search of a bypass.
- Once all reconnaissance is complete, the convoy commander determines which of the following COAs he will take:
 - Bypass the obstacle.
 - Breach the obstacle with the assets on hand.
 - Breach the obstacle with reinforcing assets.

NOTE: The convoy may encounter an impromptu checkpoint, with obstacles, established by civilians or noncombat elements. If the checkpoint cannot be

bypassed or breached, the commander must be prepared to negotiate passage for the convoy (based on the factors of METT-TC, the ROE, and the ROI).

- The commander relays situation reports (SITREPs) to his higher headquarters and requests support from combat reaction forces, engineer assets, and aerial reconnaissance elements, if they are not already a part of the convoy task organization.
- Artillery units or the supporting mortar sections are alerted to provide fire support.

(3) **Actions during a Halt.** During a short halt, the convoy escort remains at readiness condition (REDCON)-1 status regardless of what actions other convoy vehicles are taking. If the halt is for any reason other than an obstacle, the following actions should be taken:

(a) The convoy commander signals the short halt and transmits the order via tactical radio. Based on his analysis of the factors of METT-TC, he directs all vehicles in the convoy to execute the designated formation or drill for the halt.

(b) Ideally, the convoy assumes a herringbone or coil formation. If the sides of the road are untrafficable or are mined, however, noncombat vehicles may simply pull over and establish 360-degree security as best they can. This allows movement of the escort vehicles through the center of the convoy main body.

(c) If possible, escort vehicles are positioned up to 100 meters beyond other convoy vehicles, which are just clear of the route. This is METT-TC dependent. Escort vehicles remain at REDCON-1 but establish local security.

(d) When given the order to continue, convoy vehicles reestablish the movement formation, leaving space for escort vehicles. Once the convoy is in column, local security elements (if employed) return to their vehicles, and the escort vehicles rejoin the column.

(e) When all elements are in column, the convoy resumes movement.

8-31. OPEN AND SECURE A ROUTE

This task is a mobility operation normally conducted by the engineers. The antiarmor company may be tasked to assist in route clearance and to provide overwatch support. The route may be cleared to achieve one of several tactical purposes:

- To clear a route for the initial entry of the higher unit into an area of operations.
- To clear a route ahead of a planned convoy to ensure that belligerent elements have not emplaced new obstacles since the last time the route was cleared.
- To secure the route to make it safe for use as a main supply route (MSR).

The planning considerations associated with opening and securing a route are similar to the planning considerations for a convoy escort operation. The antiarmor company commander must analyze the route and develop contingency plans covering such possibilities as likely ambush locations and sites that are likely to be mined. (For information on combined-arms route clearance operations, refer to FM 20-32.)

8-32. CONDUCT RESERVE OPERATIONS

Reserve operations in the stability environment are similar to those in other tactical operations in that they allow the antiarmor company commander (or platoon leader) to plan for a variety of contingencies based on the higher unit's mission. As noted

throughout this section, the reserve may play a critical role in almost any stability activity or mission, including lodgment area establishment, convoy escort, and area security.

a. The reserve force must be prepared at all times to execute its operations within the prescribed time limits specified by the controlling higher headquarters.

b. The controlling higher headquarters may also tailor the size and composition of the reserve force according to its assigned mission. If the reserve force is supporting a convoy, it may consist of an augmented antiarmor platoon. If the mission is to support established checkpoints, then an antiarmor company is augmented with infantry elements.

CHAPTER 9

SUPPORT OPERATIONS

US military forces conduct support operations to assist foreign and domestic civil authorities or designated groups by providing essential supplies and services in the face of adverse conditions, usually disease, hunger, or the consequences of disasters. Mission success in support operations, which are normally characterized by the lack of an active opponent, is measured in terms of the ability to relieve suffering and to help civil authorities respond to crises. The ultimate goals of these operations are to meet the immediate needs of the supported groups and to transfer responsibility quickly and efficiently to appropriate civilian authorities. Support operations are usually nonlinear and noncontiguous. Support operations may be independent actions. Conversely, they may complement offensive, defensive, or stability operations (before, during, and after execution); refer to the discussions of antiarmor company operations in Chapter 4 (offense) and Chapter 5 (defense). (For a more detailed examination of support operations, refer to FM 3-0 and 3-07.)

Section I. TYPES OF SUPPORT OPERATIONS

There are two types of support operations: domestic support operations (DSOs) and foreign humanitarian assistance (FHA) operations. Both share four forms of operations, which occur to varying degrees in each support operation: relief operations, support to weapons of mass destruction incidents, support to civil law enforcement, and community assistance. Army units conduct DSOs in the US and its territories using active and reserve components. It conducts FHA operations abroad and under the direction of a combatant commander. Since domestic emergencies can require Army forces to respond with multiple capabilities and services, they may conduct the four forms of support operations simultaneously during a given operation.

9-1. DOMESTIC SUPPORT OPERATIONS

DSOs supplement the efforts and resources of state and local governments and NGOs within the United States. During DSOs, the US military always responds in support of another civilian agency. DSOs also include those activities and measures taken by DOD to foster mutual assistance and support between the department of defense (DOD) and any civil government agency. DSOs may include military assistance with planning or preparedness for, or in the application of resources in response to, the consequences of civil emergencies or attacks, including national security emergencies or major disasters. A presidential declaration of an emergency or disaster area usually precedes a DSO.

a. The US military provides domestic support primarily in accordance with a DOD directive for military assistance to civil authorities. The directive addresses responses to both natural and manmade disasters and includes military assistance with civil disturbances, counterdrug activities, counterterrorism activities, and law enforcement.

b. DSOs focus on the condition of all types of natural and manmade properties, with the goal of helping to protect and restore these properties as requested. Typically,

environmental operations are conducted in response to such events as forest and grassland fires, hazardous material releases, floods, and earthquakes.

9-2. FOREIGN HUMANITARIAN ASSISTANCE.

US forces conduct FHA operations outside the borders of the US or its territories to relieve or reduce the results of natural or manmade disasters or other endemic conditions, such as human suffering, disease, or deprivation, that might present a serious threat to life or that can result in great damage to or loss of property.

(1) The US military typically supplements the host nation authorities in concert with other governmental agencies, NGOs, PVOs, and unaffiliated individuals. Most foreign humanitarian assistance operations closely resemble domestic support operations. The distinction between the two is the legal restrictions applied to US forces inside the US and its territories. The Posse Comitatus Act does not apply to US forces overseas.

(2) FHA operations are limited in scope and duration. They focus exclusively on prompt aid to resolve an immediate crisis. Crises or disasters caused by hostile individuals or factions attacking a government are normally classified as stability rather than support operations. In environments where the situation is vague or hostile, support activities are considered a subset of a larger stability or offensive or defensive operation.

9-3. CATEGORIES OF SUPPORT OPERATIONS.

Support operations may be independent actions, or they may complement offensive, defensive, and stability operations. Most offensive, defensive, and stability operations require some form of support operations before, during, and after execution. Support operations generally fall into four categories:

- Relief operations.
- Support to incidents involving chemical, biological, radiological, nuclear, and high-yield explosive consequence management (CBRNE-CM).
- Support to civil law enforcement.
- Community assistance.

a. **Relief Operations.** In general, the actions performed during relief operations are identical in both DSO and FHA operations. The actions can be characterized as either humanitarian relief, which focuses on the well being of supported populations, or disaster relief, which focuses on recovery of critical infrastructure after a natural or manmade disaster. Relief operations accomplish one or more of the following objectives:

- Save lives.
- Reduce suffering.
- Recover essential infrastructure.
- Improve quality of life.

(1) **Disaster Relief.** Disaster relief encompasses those actions taken to restore or recreate the minimum infrastructure to allow effective humanitarian relief and set the conditions for longer-term recovery. This includes establishing and maintaining minimum safe working conditions plus the security measures necessary to protect relief workers and the affected population from additional harm.

(2) **Humanitarian Relief.** Humanitarian relief focuses on life-saving measures to alleviate the immediate needs of a population in crisis. It often includes the provision of medical support, food, water, medicines, clothing, blankets, shelter, and heating or

cooking fuel. In some cases it involves transportation support to move affected people from a disaster area.

b. **Support to Chemical, Biological, Radiological, Nuclear, and High-yield Explosive Consequence Management (CBRNE-CM).** CBRNE-CM incidents are deliberate or unintentional events involving chemical, biological, radiological, nuclear, and high-yield explosives that produce catastrophic loss of life or property. Army forces assist civil authorities in protecting US territory, population, and infrastructure prior to an attack by supporting domestic preparedness and critical asset protection programs. If an attack occurs, response to the consequences of the attack may include the following types of support:

- Decontamination and medical care, including assessment.
- Triage treatment.
- MEDEVAC.
- Hospitalization.
- Follow-up on victims of chemical and biological agents.
- Transportation.
- Bomb dogs.
- Imagery.
- Public affairs.

c. **Support to Civil Law Enforcement.** Support to domestic civil law enforcement generally involves support activities related to counterterrorism, counterdrug operations, civil disturbance operations, or general support. Support may involve providing resources, training, or direct support. Federal forces remain under the control of their military chain of command at all times while providing the support.

d. **Community Assistance.** Community assistance is a broad range of activities that provides support and maintains a strong connection between the military and civilian communities. Community assistance activities provide effective means of projecting a positive military image, providing training opportunities, and enhancing the relationship between the Army and the American public. These activities should fulfill community needs that would not otherwise be met. Community activities can enhance individual and unit combat readiness. Projects should exercise individual soldier skills, encourage teamwork, and challenge leaders' planning and coordination skills. They should result in measurable accomplishments and increase soldier proficiency. Commanders of forward-deployed Army units may also apply those concepts when fostering or establishing relationships with host nation communities.

(1) State and local efforts also improve the community's perception of the Army. Community assistance varies widely ranging from individual soldier involvement to full installation participation. An installation or organization can enter into an agreement with the local community to provide critical services not available in the community, to augment community services unable to meet demand, or to ensure that emergency services are available in the shortest possible time.

(2) Participation in public events, memorials, and exhibits facilitates interaction between soldiers and the local community. This contact communicates the professionalism, readiness, and standards of the Army. Individual soldiers serve as representatives and role models to the civilian community, promote and inspire

patriotism, and generate interest in the Army. This increased public awareness enhances the Army's reputation and secures the confidence of the American people.

(3) Laws, regulations, and policies limit Army participation in community assistance activities. Commanders consider the objective and purpose of community assistance and the limitations under which Army participation in community assistance activities is authorized. Commanders ensure that their initiatives do not compete with local resources or services and do not result in remuneration in any form. Commanders also avoid providing assistance and support to one segment of a community when they cannot also provide the same assistance to others. Actions that appear to benefit a particular group can foster perceptions of bias or partisanship. Ideally, support should be provided only to events and activities of common interest and benefit across the community.

Section II. CONSIDERATIONS FOR SUPPORT OPERATIONS

Although each support operation is different, troop-leading procedures used in offensive, defensive, and stability operations still apply. The following considerations supplement those processes and can help commanders develop tailored concepts and schemes for support operations.

9-4. PROVIDE ESSENTIAL SUPPORT TO THE LARGEST NUMBER OF PEOPLE

The principle of essential support to the largest number guides prioritization and allocation. Commanders allocate finite resources to achieve the greatest good.

a. Initial efforts usually focus on restoring vital services, which include food and water distribution, medical aid, power generation, search and rescue, firefighting, and community relations. It may be necessary to complete a lower-priority task before accomplishing a higher one. For example, units may need to restore limited electrical services before restoring hospital emergency rooms and shelter operations.

b. Commanders assess requirements to employ units effectively. They determine how and where to apply limited assets to benefit the most people. In some cases, warfighting reconnaissance capabilities and techniques are adaptable to support operation requirements. For example, mounted patrols using thermal sights can survey relief routes and locate civilian refugee groups. Standard information collection methods are reinforced and supplemented by civil affairs or dedicated disaster assessment teams, as well as interagency, host nation, and NGO sources. The combination of traditional and nontraditional information support allows commanders to obtain a clear understanding of the situation and adjust plans accordingly.

9-5. COORDINATE ACTIONS WITH OTHER AGENCIES

DSOs and FHA operations are typically joint and interagency; FHA operations are also multinational. The potential for duplication of effort and working at cross-purposes is high. Unity of effort requires, as a minimum, common understanding of purposes and direction among all agencies. Ensuring unity of effort and efficient use of resources requires constant coordination. Army forces enhance unity of effort by establishing a civil military operations center (CMOC) in FHA operations and by providing liaison elements, planning support, advisors, and technical experts to lead civil authority in DSOs. Commanders determine where their objectives and plans complement or conflict

with those of other key agencies through these contacts. Each participant's capabilities are in constant demand.

9-6. ESTABLISH MEASURES OF EFFECTIVENESS

In conjunction with supported agencies and governments, commanders establish relevant measures of effectiveness (MOEs), similar to the tactical METT-TC factors considered during mission analysis, to gauge mission accomplishment. MOEs focus on the condition and activity of those being supported. Because they are discrete and measurable and they link cause and effect, they are helpful in measuring the progress and success of the operation. In famine relief, for example, it may be tempting to measure effectiveness only by the gross amount of food delivered. This may be an acceptable MOE, but a better MOE may be the total nourishment delivered, as measured by the total number of calories delivered per person per day or the rate of decline of deaths directly attributable to starvation. MOEs depend on the situation and require readjustment as situations and guidance change.

9-7. HAND OVER TO CIVILIAN AGENCIES AS SOON AS FEASIBLE

The timing and feasibility of the handover from military to civilian authorities depends on mission-specific considerations. The two most important of these are the ability of civil authorities to resume operations without Army assistance and the necessity of committing Army forces to competing operations. Commanders identify and include civil considerations as early as possible in the planning process. Commanders must continually consider the long-term goals of the civil leadership and the communities they assist. While the immediate goal of support operations is to relieve hardship and suffering, the ultimate goal is to create those conditions necessary for civil follow-on operations. The successful handover of all activities to civil authorities and withdrawal of Army units is a positive signal to the supported population and the Army. It indicates that the community has recovered enough for civil agencies to resume control, that life is beginning to return to normal, and that the Army unit has successfully completed its support mission.

9-8. TRANSITION TO COMBAT

In some support operations (typically those that take place in an active combat theater), the company commander must remain prepared to defend himself or to attack forces that threaten his command. This applies differently in each operation. It may mean maintaining a reserve within the company. It may even compel the company to dispose its forces in ways that allow immediate transition from support operations to combat.

Section III. PHASES OF SUPPORT OPERATIONS

Although each operation is unique, support operations are generally conducted in three broad phases: response, recovery, and restoration. Army elements can expect to be most heavily committed during the response phase. They are progressively less involved during the recovery phase, with only very limited activity, if any, during the restoration phase.

9-9. RESPONSE PHASE

In the response phase, commanders focus on the life-sustaining functions that are required by those in the disaster area. The following functions dominate these response operations:

- Search and rescue.
- Emergency flood control.
- Hazard identification.
- Food distribution.
- Water production, purification, and distribution.
- Temporary shelter construction and administration.
- Transportation support.
- Fire fighting.
- Medical support.
- Power generation.
- Communications support.

9-10. RECOVERY PHASE

Recovery phase operations begin the process of returning the community infrastructure and related services to a status that meets the immediate needs of the population. Typical recovery operations include the following:

- Continuation of response operations as needed.
- Damage assessment.
- Power distribution.
- Water and sanitation services.
- Debris removal.

9-11. RESTORATION PHASE

Restoration is a long-term process that returns the community to pre-disaster normality. Restoration activities do not generally involve large numbers of military forces. When they are involved, Army elements generally work with affected communities in the transfer of responsibility to other agencies as military support forces redeploy.

CHAPTER 10

COMBAT SUPPORT

For a unit to achieve its full combat potential, the commander must understand command and support relationships and effectively integrate all available combat support assets. This chapter focuses on the CS elements with which the antiarmor company is most likely to work: fire support, intelligence, and maneuver support. The SBCT antiarmor company commander must not only understand combat support but also the nuances of having assigned CS assets within the SBCT.

Section I. COMMAND AND SUPPORT RELATIONSHIPS

The company commander must understand the command or support relationships established between his company and other units. Command relationships define command responsibility and authority. Support relationships define the purpose, scope, and effect desired when one capability supports another. For more detailed information, see FM 5-0 (101-5).

10-1. COMMAND RELATIONSHIPS

Command responsibility and authority are established routinely through the following standard relationships:

a. **Assigned.** This is a unit that is placed in an organization on a relatively permanent basis and is controlled and administered by the organization to which it is assigned for its primary function.

b. **Attached.** This is the temporary placement of units or personnel in an organization. The attached unit is under the command of the commander of the unit to which it is attached.

(1) The commander exercises the same degree of command and control as with his assigned units.

(2) Attachments are subject to limitations specified by the commander who directed the attachment. This relationship includes the responsibility for operations CSS, Uniform Code of Military Justice (UCMJ), and training. (The parent unit retains the responsibility for transfer and promotion of personnel.) It does, however, impose an administrative and logistical burden on the unit to which the attachment is made.

c. **Operational Control.** This relationship places a unit under the control of a commander for specific operations. The relationship is limited by function, time, or location. OPCON allows a commander to organize and employ the OPCON unit, assign tasks, designate objectives, and give authoritative direction necessary to accomplish the mission; however, OPCON does not include responsibility for administration, logistics, discipline, internal organization, or training.

10-2. SUPPORT RELATIONSHIPS

Where command relationships define command responsibility and authority, support relationships define the purpose, scope, and effect desired when one capability supports another. Support relationships establish specific responsibilities between supporting and supported units. The commander's relationship with supporting units is as follows:

- He ensures that the supporting unit establishes liaison and communications with his unit.
- He keeps the supporting unit informed of the situation and the support needed.
- The supporting unit leader advises him of the employment considerations.

Requests to a supporting unit for support are honored as an order. In case of a conflict, the supporting unit leader refers the matter to his parent unit commander. The request or order in question, however, will be honored until the conflict is resolved. The supporting relationships most commonly encountered by antiarmor units include direct support and general support.

a. **Direct Support.** Direct support is when one unit, under command of its parent unit commander, supports another specific unit. The supporting unit answers directly to the supported unit's requests. The commander may not suballocate, reassign, or task-organize the force supporting him. The DS unit still has a command relationship with its parent organization, but the supported unit has positioning authority and establishes the priorities of support.

b. **General Support.** Organizations providing general support (GS) to a unit are under control of their parent unit commander. They support the unit as a whole, not any specific element. The commander must request support from a GS unit through his controlling headquarters. The GS unit's parent organization retains positioning authority and establishes the priorities of support.

Section II. FIRE SUPPORT

Fire support (FS) consists of the fires and effects that directly support maneuver forces to engage enemy forces, combat formations, and facilities in support of operational and tactical objectives.

NOTE: The term "fire support" is used to address both "fire support" and "fires and effects." The acronym FSO will be used to refer to the SBCT antiarmor company FSO and the battalion FSO in the light, airborne, and air assault infantry battalions.

10-3. FIRE SUPPORT CONSIDERATIONS.

Artillery, and in some cases tactical aircraft and or attack helicopters supporting the brigade or battalion, responds to calls for fire based on the priority of fire.

a. The FSO or company commander, in coordination with the plans developed by the brigade or battalion commander or S3s, plans artillery fire to support the concept of the operation. The integration of indirect fires is critical to the success of the unit. The effects of these fires on an enemy force are much greater than the effects of the unit's organic weapons. Artillery and mortars provide the most destructive, accurate, and flexible combat multiplier the commander (or platoon leader) has to employ. Table 10-1 lists the capabilities of the indirect fire systems that may support the unit.

CALIBER:	60-mm	81-mm	81-mm (improved)	120-mm	105-mm	105-mm	155-mm
MODEL:	M224	M29A1	M252	M285	M119	M198	M109A6
MAX RANGE (HE)(m):	3,490	4,595	5,608	7,200	14,000	18,100	18,100
PLANNING RANGE (m):					11,500	14,600	14,600
PROJECTILE:	HE, WP, ILLUM,	HE, WP, ILLUM,	HE, WP, ILLUM, RP	HE, SMK, ILLUM,	HE M760 ILLUM, HEP-T, APICM, CHEM, RAP	HE, WP, ILLUM, SMK, CHEM, NUC, RAP, FASCAM, CPHD, AP/ DPICM	HE, WP, ILLUM, SMK, CHEM, NUC, RAP, FASCAM, CPHD, AP/ DPICM
MAX RATE OF FIRE:	30 RPM FOR 1 MIN	30 RPM FOR 1 MIN	30 RPM FOR 2 MIN	15 RPM FOR 3 MIN	6 RPM FOR 1 MIN	4 RPM FOR 1 MIN	4 RPM FOR 1 MIN
SUSTAINED RATE OF FIRE (rd/min):	20	8	15	5	3	2	2
MINIMUM RANGE (m):	70	70	83	180	DIRECT FIRE		
FUZES:	MO	PD, VT, TIME, DLY	PD, VT, TIME, DLY	MO	PD, VT, MTSQ, CP, MT, DLY	PD, VT, CP, MT, MTSQ, DLY	PD, VT, CP, MT, MTSQ, DLY
LEGEND: AP - Armor Piercing APICM – Antipersonnel Improved Conventional Munitions CHEM – Chemical CP - Concrete Piercing CPHD – Copperhead DLY – Delay DPICM - Dual Purpose Improved Conventional Munitions FASCAM - Family of Scatterable Mines HE - High Explosive HEP-T - High Explosive Plastic Tracer ILLUM – Illumination MIN – Minute MO - Multioption - VT, PD, DLY MT - Mechanical Time MTSQ - Mechanical Time Super Quick NUC - Nuclear PD - Point Detonating RAP - Rocket Assisted Projectile RD - Round RP - Red Phosphorus RPM - Rounds per Minute SMK - Smoke TIME - Adjustable Time Delay VT - Variable Time WP - White Phosphorus							

Table 10-1. Indirect-fire capabilities.

b. Field artillery can fire a variety of ammunition, including high explosive, illumination, and white phosphorous ammunitions. The 155-mm units can also fire dual-purpose improved conventional munitions (DPICMs) and scatterable mines. The DPICM is a lethal antipersonnel and antiarmor munition containing bomblets that are dispersed over a wide area because they are ejected high above the target during the flight of the projectile. The bomblets can penetrate up to 4.5 inches of armor. Families of scatterable mines rounds (FASCAM) contain a number of mines with self-destruct features that are set to detonate at specific times (Table 10-2, page 10-4). The rounds may contain either antipersonnel or antiarmor mines that arm shortly after impact. Companies do not normally plan or employ FASCAM, but the company commander should be familiar with these weapons (for more information see FM 7-20).

OTYPE OF MINE	ARMING TIME	SELF-DESTRUCT TIMES
Adam (AP)	2 minutes	4 hours or 48 hours
RAAM (AT)	45 seconds	4 hours or 48 hours
GEMSS	45 minutes	5 days or 15 days
MOPMS	2 minutes	4 hours
Gator/Volcano	2 minutes	48 hours or 15 days

Table 10-2. FASCAM arming and self-destruct times.

c. Artillery fire and mortars can be combined to cover targets. For example, mortars can fire illumination while artillery fires high explosives or DPICMs. The company commander must ensure his company employs each system (mortars, artillery, and direct fire) when and where it has the greatest effect on the enemy.

10-4. FIRE SUPPORT PLANNING

Fire support planning is conducted concurrently with maneuver planning at all levels. Battalions and brigades typically use top-down fire support planning, with bottom-up refinement of the plans.

- The commander develops guidance for fire support in terms of tasks and purposes.
- The fire support planner determines the method to be used in accomplishing each task; he also specifies an end state that quantifies task accomplishment.
- The fire support planner determines the method to be used in accomplishing each task.
- Individual units then incorporate assigned tasks into their fire support plans.

In addition, units tasked to initiate fires must refine and rehearse their assigned tasks. This means that the company commander refines his unit's assigned portion of the brigade or battalion's fire support plan to ensure that the designated targets will achieve the intended purpose. He also conducts rehearsals to prepare for the mission and, as specified in the plan, directs the company to execute its assigned targets.

a. Essential Fire Support Task Planning. The brigade and battalion employ effects-based fires to set the conditions for its operations. The objective of effects-based fires is to apply a desired effect to achieve a specified purpose in time and space by servicing targets as acquired. This approach develops an essential fire support task to focus full spectrum effects against a high-payoff target within the designated area of operation. An EFST is defined as the application of fires required to support a course of action; failure of the fire support unit to achieve an EFST may require a maneuver commander to alter his tactical plan. A complete EFST consists of a task, purpose, method, and effects.

- The *task* is the effect (what) desired to apply against the target (for example, suppress and obscure the enemy on hill 197).

- The *purpose* (why) is the combined arms outcome desired as a result of applying the effect (for example, enable the breach force to reduce the obstacle and establish far side security).
- The *method* (how) consists of acquisition and tracking, delivery of effects (lethal and nonlethal), and restrictions.
- *Effects* are essential to determine (quantify or qualify) if the desired effect was created and the purpose was achieved.

In order for the FSO to meet the challenges of achieving the EFST, he must ensure that full spectrum effects are produced through the integrated and synchronized application of lethal and nonlethal capabilities. This method is the continuous process of planning, integrating, and orchestrating full spectrum fire support in support of the combined arms operation to enable the achievement of the commander's desired end state. The application of fire support must be fully nested within the unit's concept of the operation. During the execution of the tactical plan, digitization of information is essential to provide responsive and precise effects and serves as a cornerstone of effects-based fires. A prime example is the integration of digital enemy locations with the digital call for fire to produce effective rounds on the enemy in the shortest amount of time possible.

b. **Linking Tasks and Maneuver Purpose.** A clearly defined maneuver purpose enables the maneuver commander to articulate precisely how he wants fire support to affect the enemy during different portions of the battle. This in turn allows fire support planners to develop a fire support plan that effectively supports the intended purpose. They can determine each required task (in terms of effects on target), the best method for accomplishing each task (in terms of a fire support asset and its fire capabilities), and a means of quantifying accomplishment. A carefully developed method of fire is equally valuable during execution of the fire mission; it assists not only the firing elements but also the observers who are responsible for monitoring the effects of the indirect fires. With a clear understanding of the intended target effects, fire support assets and observers can work together effectively, planning and adjusting the fires as necessary to achieve the desired effects on the enemy. The following paragraphs describe several types of targeting objectives associated with fire support tasks and provide examples of how the company commander might link a target task to a specific maneuver purpose in his order.

(1) **Delay.** The friendly force uses indirect fires to cause a particular function or action to occur later than the enemy desires. For example, "Delay the repositioning of the enemy's antitank reserve, allowing Team B to consolidate on OBJECTIVE BOB."

(2) **Disrupt.** Disrupting fires are employed to break apart the enemy's formation, to interrupt his tempo and operational timetable, to cause premature commitment of his forces, or to otherwise force him to stage his attack piecemeal. For example: "Disrupt the easternmost first-echelon MRB to prevent the enemy from massing two MRBs against Company B and Company D."

(3) **Limit.** Indirect fires are used to prevent an action or function from being executed where the enemy wants it to occur. For example: "Limit the ability of the enemy's advance guard to establish a firing line on the ridge line to the flank of the battalion axis of advance to prevent the enemy from fixing the battalion main body."

(4) **Divert.** Diverting fires are employed to cause the enemy to modify his course or route of attack. For example: "Divert the enemy's combined arms reserve counterattack to EA DOG to facilitate its destruction by Company D."

(5) **Screen.** Screening fires entail the use of smoke to mask friendly installations, positions, or maneuver. They are normally conducted for a specified event or a specified period of time. For example: "Screen the movement of the counterattack force along ROUTE RED to ABF 21 to prevent the remnants of the enemy MRB from engaging the company."

(6) **Obscure.** Smoke is placed between enemy forces and friendly forces or directly on enemy positions, with the purpose of confusing and disorienting the enemy's direct fire gunners and artillery forward observers. Obscuration fires are normally conducted for a specified event or a specified period of time. For example: "Obscure the northernmost enemy strongpoint to allow A company to breach."

NOTE: The supported commander may also designate purposes for special munitions such as area denial artillery munition (ADAM) and remote antiarmor munition (RAAM), Copperhead, or illumination rounds.

c. **Final Protective Fire Planning.** A final protective fire is designed to create a final barrier, or "steel curtain," to prevent a dismounted enemy from moving across defensive lines. FPFs are fires of last resort; as such, they take priority over all other fires, to include priority targets. The employment of an FPF presents several potential problems. They are linear fires, with coverage dependent on the firing sheaf of the fire support asset(s). In addition, while an FPF may create a barrier against penetration by enemy infantry, armored vehicles may simply button up and move through the fires into the friendly defensive position. FPFs are planned targets and thus must have a clearly defined purpose (see paragraph 10-8).

d. **Target Refinement.** The company commander (or platoon leader) is responsible for the employment of indirect fires in his area of operation (zone or sector). The most critical aspect of this responsibility is target refinement, in which he makes necessary changes to the fire support plan to ensure that targets accomplish the infantry battalion or SBCT commander's intended battlefield purpose. Rather than merely executing targets without regard to the actual enemy situation, the company commander (or platoon leader) and FSO must be ready to adjust existing targets or to nominate new targets that allow engagement of specific enemy forces.

(1) Necessary refinements usually emerge when the company commander (or platoon leader) conducts course of action analysis (war-gaming) as part of step 6 (complete the plan) of troop-leading procedures (see Chapter 2). The war-gaming process allows him to identify required additions, deletions, and adjustments to the higher unit's fire support plan. The FSO then submits the refinements to the higher headquarters fire support element (FSE) for inclusion in the scheme of fires for the operation. The light infantry battalion antiarmor platoon leader will coordinate all of this directly with the FSE or with the company commander to whom his platoon is attached or OPCON.

NOTE: This is normally only the first step of target refinement, with the commander, platoon leader, and FSO making further adjustments as the enemy situation becomes clearer.

(2) As a specific requirement in defensive planning, the company commander must focus on target refinement for his area of operation. This usually takes place as part of engagement area development. The commander makes appropriate adjustments to the targets based on refinements to the SITEMP, such as the actual positions of obstacles and enemy direct fire systems. The light infantry battalion antiarmor platoon leader will most likely coordinate this through the company commander to whom his platoon is attached or OPCON.

(3) Because fire support is planned from the top down, cutoff times for target nomination and target refinement are normally specified in the higher unit OPORD. Nominations and refinements must meet these deadlines to provide fire support planners with sufficient time to develop execution plans.

e. **Fire Support Preparation.** As noted, although the SBCT and battalion commanders establish target tasks and purposes and allocate appropriate fire support assets, the company commander (or platoon leader) is the one who must ensure execution of assigned targets. In turn, successful execution demands thorough preparation, focusing on areas covered in the following paragraphs.

(1) **Observation Plan.** In developing the observation plan, the commander (or platoon leader) must ensure that both primary and alternate observers cover all targets. The plan must provide clear, precise guidance for the observers. Perhaps the most important aspect of the plan is positioning; observers' positions must allow them to see the trigger for initiating fires as well as the target area and the enemy force on which the target is oriented. The commander (or platoon leader) must also consider other aspects of observer capabilities, including available equipment. For example, the ground/vehicle laser locator designator (G/VLLD) provides first-round fire-for-effect capability; without it, observers may have to use adjust-fire techniques that take longer and are more difficult to implement. The observation plan must also include contingency plans that cover limited visibility conditions and backup communications. (See paragraph 10-10.)

NOTE: In addition to providing the specific guidance outlined in the observation plan, the commander (or platoon leader) must ensure that each observer understands the target task and purpose for which they are responsible. For example, observers must understand that once the first round impacts, the original target location is of no consequence; rather, they must orient on the targeted enemy force to ensure that fires achieve the intended battlefield purpose.

(2) **Rehearsals.** The company commander is responsible for involving the FSO in company- and higher-level rehearsals, for making the company available for any separate fire support rehearsals, and for rehearsing the company's observers in the execution of targets. He should also use rehearsals to ensure that the company's primary and backup communications systems will adequately support the plan. The light infantry battalion antiarmor platoon leader and selected subordinates will participate in higher-level fire support rehearsals. The platoon should incorporate fire support tasks within its own rehearsal. (See paragraph 10-11.)

(3) **Target Adjustment.** In the defense, the commander should confirm target location by adjusting fires as part of engagement area development.

(4) **Trigger Planning.** The company commander (or platoon leader) develops a trigger for each target. The trigger can be a point on the ground, such as an easily recognizable terrain feature, an emplaced marker, or a designated linear control measure. In the defense, triggers should be physically marked on the ground or their location specifically selected and identified during the development of the engagement area.

NOTE: Triggers can be marked using techniques similar to those for marking TRPs.

(a) The trigger line or point must be tied to clearly understood engagement criteria associated with the targeted enemy force. As an example, the company commander might use the following order to begin indirect fires: "Initiate target AE0001 when approximately 30 BMPs and 10 T-80s cross PL ORANGE."

(b) Several factors govern the positioning of the trigger. The enemy's rate of march and the resulting time required for the enemy force to move from the trigger to the target area are especially critical factors. Using this information, the commander (or platoon leader) can then select the trigger location based on the following considerations:

- The amount of time required to make the call for fire.
- The time needed by the fire support element to prepare for and fire the mission.
- The time required for the higher headquarters to clear the fires.
- Any built-in or planned delays in the firing sequence.
- The time of flight of the indirect fire rounds.
- Possible adjustment times.

The company commander (or platoon leader) can use the information in Tables 10-3 and 10-4 as a guide to determine the trigger location in relation to the target area. Table 10-3 lists the time required for the enemy force to move a specified distance at a specified rate of march. Table 10-4 lists the response time required by field artillery assets to prepare for and fire various types of support missions.

RATE OF MARCH	DISTANCE TRAVELED									
	1 km	2 km	3 km	4 km	5 km	6 km	7 km	8 km	9 km	10 km
60 km/hr	1	2	3	4	5	6	7	8	9	10
50 km/hr	1.2	2.4	3.6	4.8	6	7.2	8.4	9.6	10.8	12
40 km/hr	1.5	3	4.5	6	7.5	9	10.5	12	13.5	15
30 km/hr	2	4	6	8	10	12	14	16	18	20
25 km/hr	2.4	4.8	7.2	9.6	12	14.4	16.8	19.2	21.6	24
20 km/hr	3	6	9	12	15	18	21	24	27	30
15 km/hr	4	8	12	16	20	24	28	32	36	40
10 km/hr	6	12	18	24	30	36	42	48	54	60
5 km/hr	12	24	36	48	60	72	84	96	108	120

Table 10-3. Time (in minutes) required to travel a specified distance.

GRID OR POLAR MISSION (UNPLANNED)	5-7 minutes
PREPLANNED MISSION	3 minutes
PREPLANNED PRIORITY MISSION	1-2 minutes
NOTE: These are approximate times needed to process and execute calls for fire on normal artillery targets. Special missions may take longer.	

Table 10-4. Artillery response times (in minutes).

(5) **Shifting Fires.** As in trigger planning for the initiation of fires, the commander must establish triggers for shifting fires based on battlefield events such as the movement of enemy or friendly forces. One technique is the use of a minimum safe line (MSL) when a friendly element, such as a breach force, is moving toward an area of indirect fires. As the element approaches the MSL, observers call for fires to be shifted, allowing the friendly force to move safely in the danger area.

(6) **Clearance of Fires.** The maneuver commander has the final authority to approve (clear) fires and their effects within his AO. Although he may delegate authority to coordinate and clear fires to an FSO, the ultimate responsibility belongs to the company commander. An FSO may assist the commander by making recommendations on the clearance of fires.

(7) **Fire Support Execution Matrix.** As a tool in fire support planning and execution, the company commander (or platoon leader) may develop a graphic summary outlining the critical elements of the fire support plan and the unit's role in it. The commander (or platoon leader) may incorporate this information into his own execution matrix or into a separate fire support execution matrix, similar to the battalion's fire support execution matrix, as illustrated in Table 10-5, page 10-10. The company fire support execution matrix is similar and should include, as a minimum, the following information for each target:

- Target number and type, to include FPF designation.
- Allocated fire support assets and munitions type.
- Observer and backup observer.
- Trigger.
- Target purpose.
- Target grid.
- Priority of fire.
- Priority targets.
- Fire support coordination measures (FSCMs).

EVENT SUPPORT DATA	EVENT I (LD to SBF 01)	EVENT II (Set conditions for breach from SBF 01)	EVENT III (B Company breach)	EVENT IV (C Company assault)
TARGET/ GRID	AE0001 (PK 10184938).	AE0002 (PK 09005031).	O/O shift AE0001 to AE0003 (PK 10204810) and lift AE0002.	O/O lift AE0003.
ASSET	155-mm HE.	Mortar smoke.	155-mm.	155-mm.
OBSERVER/ BACKUP	Recon platoon will initially call for and adjust fires; FSO adjusts upon arrival at SBF; 1st platoon leader is backup.	FSO (primary)/ 1st platoon leader (backup).	AE0003: FSO (primary)/ 2d platoon leader (backup).	FSO (primary)/ 3d platoon leader (backup).
TRIGGER	C Company crosses PL LYNX.	On-call at SBF.	B Company crosses PL LION.	C Company completes consolidation on OBJ BOB.
PURPOSE	Disrupt enemy on OBJ BOB to facilitate maneuver of A Company to SBF position.	Obscure enemy to prevent interference with B Company's breach.	Disrupt MRB reserve to protect the assault force (C Company).	Protect the assault force (C Company).

Table 10-5. Example battalion fire support execution matrix.

10-5. MANEUVER COMMANDER'S INTENT

The company commander must ensure the FSO clearly understands the intent for maneuver and fires support. He identifies the role of fire support in the scheme of maneuver (when, where, what, and why) by explaining to the FSO in detail the concept of the operation, scheme of maneuver, and tasks for fire support.

a. Providing this level of guidance is not easy. Artillery fires are not instantaneous, and planning must allow for this lag time. It takes three to seven minutes to process targets of opportunity. While war-gaming the maneuver, the company commander (or platoon leader) refines the critical targets or EAs, priority of targets, priority of engagement, sequence of fires, and results desired. Then he can see when and how to synchronize direct and indirect fires to destroy the enemy and protect the force.

b. The company commander (or platoon leader) normally establishes a priority of fires for his unit. This prioritizes requests when two or more units call for fires at the same time. He also designates where to place obscuration or illumination, suppressive fires, and preparation fires.

10-6. PLANNING PROCESS

While the company commander develops and refines the tactical plan, the FSO concurrently develops and refines the fire support portion of that plan. The FSO does not wait for the commander to complete the scheme of maneuver. He builds the fire plan using deliberate or quick fire support planning, depending on the time available. The light infantry battalion antiarmor platoon leader works concurrently with the battalion FSO or FSE, if not attached to an infantry company. Targets must be placed in the fire support planning channels as soon as possible so they can be processed at the battalion FSE or battery fire direction center (FDC). The unit's fire support plan must include:

- Target number and location.
- A description of the expected target.
- Primary and alternate persons responsible for shooting each target.
- The effect required (destroy, suppress, neutralize) and purpose.
- Radio frequency and call sign to use in requesting fires.
- When to engage the target.
- Priority of fires and shifting of priority.
- Size, location, code word, and emergency signal to begin FPF.
- Other information may be included as necessary or appropriate.

a. The battalion FSO or the company FSO (if available) does most of the company (or platoon) fire support planning; however, the FSOs may receive targets and target information from platoon leaders and the brigade fire support coordinator (FSCOORD) (or SBCT effects coordinator [ECOORD]). The company commander, platoon leader, or FSO should not plan too many targets.

(1) The number of targets planned by the unit and included in the formal fire support plan depends upon the unit's priority for fire support and the number of targets allocated to them. The total number of targets in the brigade fire support plan or the battalion mortar plan may be constrained. An excessive number of targets tends to dilute the focus of fire planning and can lead to increases in response time.

(2) Informal planning continues with target locations being recorded on terrain sketches or the FSO's map or being stored in the buffer group of the advanced field artillery tactical data system (AFATDS) for quick reference and transmission. Fire planning for the company mortars should complement these plans; the primary constraint is normally ammunition availability and rapid resupply ability. Care must be taken to ensure that planning focuses on the critical fire support requirements identified by the company commander.

b. The FSO completes the indirect fire plan and briefs the company commander. The company commander may alter the plan or approve it as is; he makes the final decision. After the company commander approves the plan, the FSO makes sure the targets are passed to the battalion FSE where the fire plans are integrated into the battalion scheme of maneuver.

c. The company commander, through his FSO, ensures platoon leaders are thoroughly familiar with the indirect fire plan. He also provides target overlays to the platoon leaders, any designated observers, and the commander. The company commander also may disseminate the company fire support plan as a target list and a fire support execution matrix. He does so in sufficient time to allow subordinates to brief their platoons and sections. (A good plan given with the company order is better than a perfect plan handed out at the line of departure.)

d. Battalion fire support plans (or SBCT fires and effects plans) may be distributed in matrix format. The fire support execution matrix is a concise, effective tool showing the many factors of a detailed plan. It may aid the commander, platoon leader, and FSO in understanding how the indirect fire plan supports the scheme of maneuver. It explains what aspects of the fire support plan each element is responsible for and at what time during the battle these aspects apply.

e. The advantage of the matrix is that it reduces the plan to one page and simplifies it. The company fire support execution matrix (Figure 10-1, page 10-13) also directs

execution responsibilities and reduces the possibility that planned fires will not be executed. Dissemination of the fire plan is the responsibility of the company commander (or platoon leader). The commander and his key subordinate leaders must understand the categories of targets and how to engage those targets to create the desired result.

f. Figure 10-1 is an example of a completed fire support execution matrix for a company deliberate attack. In the assembly area (AA), a field artillery FPF is allocated for 1st and 2d platoons; 3d platoon has been allocated a mortar FPF; 2d platoon has priority of mortar fires from the LD to Checkpoint 7. From Checkpoint 7 to Objective Green, 3d platoon has been allocated a mortar priority target and has designated it as CA3017; 2d platoon is backup for execution. 1st platoon has been allocated a mortar FPF; 2d and 3d platoons have been allocated field artillery FPFs. At company level, information in each box of the matrix includes the following:

(1) Priorities of indirect fire support to a platoon appear in the upper left corner of the appropriate box (FA). A technique is to prioritize all of the subordinate units to ensure there is an understanding when conflicts arise among all of the platoons.

(2) If a unit is allocated an FPF, the type of indirect fire means responsible for firing appears next to the indicator (FA FPF or MTR FPF).

(3) The target number of priority targets allocated to a platoon appears in the box preceded by the target, followed by the target number (MORT PRI TGT CA3014).

(4) If the company FSO is responsible for initiating specific fires, the target number, group, or series designation is listed in the box for the FSO (CA3012). Specific guidelines concerning fires not included on the target list are included in that box.

(5) Alternate element responsible for the execution of specific fires is listed in the lower right hand corner of the box (2d platoon). If fires have not been initiated when they were supposed to have been, that unit initiates them (unless ordered not to).

(6) Each fire support measure to be placed in effect, followed by a word designated for the measure, is shown in the box (CFL CHUCK). For airspace coordination areas, the time for the arrival of the planned CAS or attack helicopters is listed (ACA 1400Z).

(7) Other factors that apply to a certain platoon during a specific time may be included in the appropriate box. General guidance is issued in the written portion of the operation order.

	AA	LD	CP7	OBJ GREEN
FSO	INITIAL PREP 1ST PLT	FIRE CA 3012 CFL CHUCK 2D PLT	FIRE CA GROUP 3D PLT	ACA (CAS) 1400Z
1ST PLT	FA FPF	CFL CHUCK		MORTAR FPF
2D PLT	FA FPF	MORT PRI TGT CA 3014 CFL CHUCK		FA FPF
3D PLT	MORTAR FPF	CFL CHUCK	MORT PRI TGT CA 3017 2D PLT	FA FPF

Figure 10-1. Example of company fire support execution matrix.

10-7. TARGETS

A target can be personnel, vehicles, materiel, or terrain that is designated and numbered for reference or firing. Every target can be classified as either a target of opportunity (appears during combat, no attack has been planned) or a planned target (fire is prearranged). Individually planned targets may be further subdivided into either scheduled or on-call targets. A scheduled target is a planned target to be attacked at a specified time. An on-call target is a planned target on which fire is delivered when requested.

a. A priority target is one that could decisively affect the unit mission. The brigade commander may allocate artillery priority targets to battalions. The battalion commander may in turn allocate priority targets to his subordinate companies (or platoons). Normally, the company commander designates company priority targets. Antiarmor platoon leaders will not likely designate priority targets; rather, they will assign responsibility for observation and execution to the antiarmor squads.

b. When the battalion commander designates priority targets, he provides specific guidance to the FSO and his subordinate companies as to when certain targets become priority targets, when they cease to be priority targets, the desired effects on the targets, and any special type of ammunition to be used. Firing units lay the guns on priority targets when they are not engaged in a fire mission, which reduces reaction time. FPF is an example of a priority target in a defensive situation.

c. The FSO assigns a target number to each planned target. Blocks of alphanumeric target numbers (two letters and four numbers) are provided for all fire-planning agencies. They serve as an index to all other information regarding a particular target, such as location, description, and size. The FSO may assign target numbers to unit TRPs. Mortar sections have blocks of target numbers so they can assign a target number when an observer directs "record as target" upon completion of a registration.

d. A standard target is an area about 200 meters in width. The symbol for a standard target is a cross. It may be canted if several targets are close to each other, or if the symbol might be mistaken as a grid intersection. The intersection of the lines marks the center of the target. The target list describes the target task, target type, and other pertinent information. (This applies to targets planned for conventional and improved conventional ammunition.)

(1) **Offensive Application.** Use offensive application targets to attack known, suspected, or likely enemy positions such as OPs, antitank sites, road intersections, or terrain that dominates attack axes.

(2) **Defensive Application.** Use defensive application targets to destroy the enemy as he attacks. Plan targets at fording sites, bridges, defiles restricting movement, road intersections, obstacles, and possible enemy overwatch and support-by-fire positions.

e. When the expected target will be moving, extra planning is required. Determine a trigger point that allows a designated observer sufficient time to initiate the call for fire, the firing unit time to prepare and fire, and the projectiles time to reach the target. The observer calls for fire as the unit or vehicles reach the trigger point and the enemy continues moving to the target. If timed properly, enemy and projectiles arrive at the target at the same time.

10-8. FINAL PROTECTIVE FIRES

Final protective fires are immediately available planned fires that block enemy movement, especially dismounted infantry approaching defensive lines or areas. These areas are integrated with defensive plans. The pattern of FPF plans may be varied to suit the tactical situation; they are drawn to scale on the target overlay. The dimension of an FPF is determined by the number and type of weapon used to fire on it (Figure 10-2). The company commander (or platoon leader) is responsible for the precise location of FPFs. The company commander, platoon leader, or FSO--

- Reports the desired location of the FPF to the supporting FDC.
- Adjusts indirect fire on the desired location, by weapon.
- Transmits the call to fire FPF to the supporting FDC.

The leader (normally the company commander or a platoon leader) in whose area the FPF is located has the authority to call for the FPF. The FPF has the highest priority of any target assigned to a fire support means. The FPF is only fired when required to repel the enemy's assault. Premature firing wastes ammunition and allows the enemy to avoid the impact area.

WEAPONS	SIZE (METERS)
60-mm Mortar (2 tubes).....	60 x 30
81-mm Mortar (4 tubes).....	100 x 35
105-mm Howitzer (6 guns).....	180 x 40
120-mm Mortar (2 tubes).....	120 x 60
120-mm Mortar (4 tubes).....	240 x 60
155-mm Howitzer (4 guns).....	200 x 50
155-mm Howitzer (6 guns).....	300 x 50
155-mm Howitzer (8 guns).....	400 x 50

Figure 10-2. FPF dimensions.

10-9. SPECIAL MUNITIONS

Special munitions may be used for illumination, which may be scheduled or on-call. Use friendly direct fire weapons and adjustment of indirect fires to illuminate areas of suspected enemy movement or to orient moving units.

a. Obscuration fires use smoke and white phosphorus ammunition to degrade the enemy by obscuring his view of the battlefield. (High explosive ammunition may also obscure his view with dust and fires, but the unit should not rely on it as the primary means.) Because smoke is subject to changes in wind direction and terrain contours, its use must be coordinated with other friendly units affected by the operation. Used properly, obscuration fires can--

- Slow enemy vehicles to blackout speeds.
- Obscure the vision of enemy direct fire weapon crews.
- Reduce accuracy of enemy-observed fires by obscuring OPs and CPs.
- Cause confusion and apprehension among enemy soldiers.
- Limit the effectiveness of the enemy's visual command and control signals.

b. Screening fires are closely related to obscuration fires; they also involve the use of smoke and WP. However, screening fires mask friendly maneuver elements to disguise the nature of their operations. For example, they are used to screen river crossings for an enveloping force. Screening fires may assist in consolidating on an objective by placing smoke in areas beyond the objective. They also may be used to deceive the enemy into believing that a unit is maneuvering when it is not. Screening fires require the same precautions as obscuration fires.

10-10. OBSERVER POSITIONS

To ensure indirect fire can be called on a specific target, observers must be designated and in the proper position. As the company plans indirect fire targets to support the operation and passes these down to the platoon, specific observers are positioned to observe the target and the associated trigger line or TRP. Any soldier can perform this function as long as he understands the mission and has the communications capability and training.

a. Once the target has been passed to the platoon or included by the platoon in the fire support plan, the platoon leader must position the observer and make sure he understands the following in precise terms:

(1) The nature and description of the target he is expected to engage.

(2) The terminal effects required (destroy, delay, disrupt, suppress, and so on) and purpose.

(3) The communications means, radio net, call signs, and FDC to be called.

(4) When or under what circumstances targets are to be engaged.

(5) The relative priority of targets.

(6) The method of engagement and method of control to be used in the call for fire.

(a) *Method of Engagement (Adjust Fire or Fire for Effect)*. Anticipate the need to adjust fires when deriving target location strictly through map-spot procedures. Using this technique, expect target location errors of up to 500 meters. Employ fire for effect when the target can be precisely located through previous adjustment, target area survey, or the use of laser range finders from known locations. When fires must be adjusted, consider the additional time required to complete the fire mission (two to four minutes for each adjustment) in the planning process.

(b) *Method of Control (Time on Target, At My Command, or When Ready)*. The method of control should reflect the degree of synchronization required. While time-on-target controls the precise timing of fires, it reduces flexibility in the firing units and can result in fewer missions being fired over a given period of time.

b. If the observer cannot be positioned to see the target and trigger line or TRP under the visibility conditions expected at the time the target is to be fired, the headquarters that planned the target must be notified and a new target must be planned at a location that will meet the commander's purpose for fire support.

10-11. REHEARSAL AND EXECUTION

Once the company commander (or platoon leader) has developed and coordinated the fire support plan, the unit should rehearse the plan. As the unit rehearses the maneuver, it rehearses the fire plan. The target list is executed as the maneuver is conducted; fires are requested (though not actually executed by the firing units) just as they would be during the operations. Under ideal circumstances, FPF can be adjusted during the rehearsal. Rehearsals on the terrain reveal any problems in visibility, communications, and coordination of the fire support plan. Conduct rehearsals under degraded conditions (at night and in mission-oriented protective posture (MOPP) 4 to make sure the unit can execute the plan in all circumstances.

a. If time or conditions do not permit full-scale rehearsals, key leaders can meet, preferably at a good vantage point, and brief back the plan. They can use a sand table depiction of the terrain. Each player explains what he does, where he does it, and how he plans to overcome key-leader casualties. The fire support plan execution is integral to this process and is rehearsed in exactly the same way.

b. The unit executes the fire plan as it conducts the operation. It calls for fires on targets as required and makes adjustments based on enemy reactions. Priority targets are cancelled as friendly units pass them or they become irrelevant to the maneuver.

10-12. COMMUNICATIONS

The FSO can monitor three of four possible radio nets. The company's mission and priority determine the specific nets.

a. **Company Command Net FM (Voice).** Platoon leaders, the XO, and attachments use this net to send reports, receive instructions, and request fires. Any fire supporters attached to the company monitor this net. The company headquarters is the net control station (NCS).

b. **Battalion Mortar Fire Direction Net FM (Voice).** Observers may use this net to request fires of the battalion mortar platoon. Other stations on the net include the company's fire support team (FIST) (if attached) and the battalion FSE. The battalion mortar platoon is the NCS.

c. **Field Artillery Fire Direction Net FM (Voice).** This net is used for field artillery (FA) fire direction. The FIST headquarters may digitally forward calls for fire from its observers on this net. The direct support battalion FDC is the NCS. When an FSO or FO is present, he uses this net to request FA fires. The battery FDC and battalion FSE are also on this net.

10-13. INDIRECT FIRES IN CLOSE SUPPORT

Effective indirect fire support often requires artillery and mortar fires near friendly infantry soldiers. These close supporting fires are most commonly FPFs in a defensive operation and are suppression or obscuration fires to support an assault on an enemy position. A safe integration of fires and maneuver this close demands careful planning, coordination, and knowledge of the supporting weapons.

a. **The Effect Required.** In the defense, this may be to destroy enemy soldiers and to degrade the effectiveness of enemy vehicles by causing them to fight buttoned-up. In the attack, the suppression and obscuration of enemy positions to allow the breach and seizure of a foothold on the objective is probably the desired effect.

b. **The Accuracy of the Delivery System.** There are many variables that impact on the accuracy of the weapon. The FSO has the technical knowledge to assist the commander. Artillery and mortars are area weapons systems, which means that every round fired from the same tube impacts in an area around the target or aiming point. This dispersion is greater in length than in width. The weather conditions (wind, temperature, and humidity), the condition of the weapon, and the proficiency of the crew also affect the accuracy.

c. **The Protection of his Unit as the Rounds are Impacting.** If in well-prepared defensive positions with overhead cover, an FPF can be adjusted very close, just beyond bursting range. If required, the company commander can even call for artillery fires right on his company position using proximity or time fuses for airbursts. It is much more dangerous to call for close indirect fires during an attack. The commander considers the terrain, the breach site, and the enemy positions to determine how close to adjust his supporting indirect fires.

d. **The Integration of Indirect Suppressive Fires.** When integrating indirect suppressive fires to support the breach and assault, the following points are key:

(1) The danger increases with the size of the weapons. Use artillery to isolate the objective, use the battalion's mortars on enemy positions away from the breach site, and

use infantry rifle company mortars (if available), M203s, and direct fire weapons for close suppression.

(2) Assaulting perpendicular to the gun-target line increases the probability of safety. If the rounds are coming over the head of the assault element, the margin of safety is reduced.

(3) Light infantry company mortars firing direct lay or direct alignment are the most responsive system when available. The section is able to observe the rounds' impact and adjust accordingly. The safest method is firing the 60-mm mortar with bipods.

(4) Ideally, the firing units register prior to firing close-support missions. If not, the first rounds fired may be off target by a considerable distance. Once the firing units are adjusted on a target, shifts from that target are much more reliable.

e. **Timings and Control.** The final requirement for integrating these fires is to establish timings and control to ensure these targets are initiated, adjusted, and shifted properly. If possible, the FSO (or antiarmor platoon leader) should locate where he can observe these targets (possibly with the support element). A detailed execution matrix should be developed that assigns responsibility for each target to the leader or observer who is in the best position to control it. These soldiers must know when each target, series, or group is fired, what effect is desired on which enemy positions, and when to lift or shift the fires. Consider the use of pyrotechnic or other signals to ensure communication.

10-14. FIRE SUPPORT TEAM

The following paragraphs examine capabilities, procedures, and other considerations that affect the company fire support team and its employment in the fire support mission.

a. **Personnel.** Fire support team (FIST) personnel include the company FSO, the fire support sergeant, a fire support specialist, and a radiotelephone operator.

b. **FIST Employment.** The antiarmor company commander has two options for employment of the FIST (when it is available):

(1) **Option 1.** The company FSO works out of his vehicle, which he positions where he can most effectively observe and control execution of the fire support plan. The FSO establishes OPs that take maximum advantage of the capability of the G/VLLD (if attached) to create lethal, accurate fires. He communicates with the commander on the company command net. This option allows the FSO to maintain effective control of any designated observers and to conduct required fire support coordination. He must keep the company informed at all times of his location and the routes he will take when moving from OP to OP.

(2) **Option 2.** The element is used as a combat observation lasing team (COLT) somewhere within the battalion or brigade sector or zone and is controlled by another headquarters. The company FSO, accompanied by the fire support specialist, moves with the company commander. He brings two radios and the handheld terminal unit (HTU).

10-15. CLOSE AIR SUPPORT

The brigade or battalion supplies the company or platoon with air support in the form of close air support and attack helicopters. All services can provide close air support (CAS) to the unit. CAS missions are flown against hostile targets near friendly forces. The forward air controller (FAC) is the battalion commander's expert in planning, requesting,

and executing CAS missions. (The Air Force liaison officer (ALO) is the SBCT commander's expert.) The FAC serves as a link between the maneuver element and the attacking aircraft. The company may provide information that the FAC or tactical air control party (TACP) uses to target enemy forces. Soldiers may provide emergency control if an FAC, FSO, or forward observer (FO) is not available (the brigade or battalion commander accepts responsibility for friendly casualties). This is possible only with aircraft equipped with FM radios. Most U.S. Air Force, Navy, and Marine Corp fixed-wing aircraft only have UHF radios (A/OA-10, F16, AV-8B, F-14, F/A-18, and AC-130). For additional information, see FM 3-09.3 (6-30). The company may also provide information on battle damage as observed. Figure 10-3 shows the format for assessing and reporting battle damage.

<p>Successful or unsuccessful. Target coordinates. Time on target. Number and type destroyed. Number and type damaged. Killed by air. Wounded by air. Dud bombs.</p>
--

Figure 10- 3. Format for battle damage assessment.

a. **AC-130 Gunship.** If the enemy air defense is low, the brigade or battalion requests CAS from an AC-130 gunship. The AC-130 provides effective fires during day and night operations and flies CAS and special operations. The aircraft contains one 40-mm gun, two 20-mm guns, two 7.62-mm miniguns, and one 105-mm howitzer. It is equipped with sensors and target acquisition systems that include forward-looking infrared radar (FLIR) and low-light television.

b. **Marking Friendly Positions.** Whenever possible, friendly positions are marked to enhance safety and to provide target area references. Methods of marking friendly positions are shown in Table 10-6, pages 10-20 and 10-21.

METHOD	DAY/ NIGHT	ASSETS	FRIENDLY MARKS	TARGET MARKS	REMARKS
SMOKE	D/N	ALL	GOOD	GOOD	Easily identifiable, may compromise friendly position, obscure target, or warn of fire support employment. Placement may be difficult due to structures.
SMOKE (IR)	D/N	ALL/ NVD AT NIGHT	GOOD	GOOD	Easily identifiable, may compromise friendly position, obscure target, or warn of fire support employment. Placement may be difficult due to structures. Night marking is greatly enhanced by the use of IR reflective smoke
ILLUM, GROUND BURST	D/N	ALL	N/A	GOOD	Easily identified, may wash out NVDs.
SIGNAL MIRROR	D	ALL	GOOD	N/A	Avoids compromise of friendly location. Dependent on weather and available light and may be lost in reflections from other reflective surfaces (windshields, windows, water, etc.)
SPOT LIGHT	N	ALL	GOOD	MARGINAL	Highly visible to all. Compromises friendly position and warns of fire support employment. Effectiveness is dependent upon degree of urban lighting.
IR SPOT LIGHT	N	ALL NVD	GOOD	MARGINAL	Visible to all with NVGs. Less likely to compromise than overt light. Effectiveness dependent upon degree of urban lighting.
IR LASER POINTER (below .4 watts)	N	ALL NVG	GOOD	MARGINAL	Effectiveness dependent upon degree of urban lighting.
IR LASER POINTER (above .4 watts)	N	ALL NVD	GOOD	GOOD	Less affected by ambient light and weather conditions. Highly effective under all but the most highly lit or worst weather conditions. IZLID-2 is the current example.
VISUAL LASER	N	ALL	GOOD	MARGINAL	Highly visible to all. Risk of compromise is high Effectiveness dependant upon degree of urban lighting.
LASER DESIG- NATOR	D/N	PGM OR LST EQUIPED	N/A	GOOD	Highly effective with PGM. Very restrictive laser acquisition cone and requires line of sight to target. May require pre-coordination of laser codes
TRACERS	D/N	ALL	N/A	MARGINAL	May compromise position. May be difficult to distinguish mark from other gunfire. During daytime use, may be more effective to kick up dust surrounding target.
ELEC- TRONIC BEACON	D/N	SEE REMARKS	EXCELLENT	GOOD	Ideal friendly marking device for AC-130 and some USAF fixed wing (not compatible with Navy or Marine aircraft). Least impeded by urban terrain. Can be used as a TRP for target identification. Coordination with aircrews essential to ensure equipment and training compatibility.
STROBE (OVERT)	N	ALL	MARGINAL	N/A	Visible by all. Effectiveness dependent upon degree of urban lighting.
STROBE (IR)	N	ALL NVD	GOOD	N/A	Visible to all NVDs. Effectiveness dependent upon degree of urban lighting. Coded strobes aid in acquisition

Table 10-6. Methods of marking friendly positions.

METHOD	DAY/ NIGHT	ASSETS	FRIENDLY MARKS	TARGET MARKS	REMARKS
FLARE (OVERT)	D/N	ALL	GOOD	N/A	Visible by all. Easily identified by aircrew.
FLARE (IR)	N	ALL NVD	GOOD	N/A	Visible to all NVDs. Easily identified by aircrew.
GLINT/IR PANEL	N	ALL NVD	GOOD	N/A	Not readily detectable by enemy. Very effective except in highly lit areas.
COMBAT IDENTIFI- CATION PANEL	D/N	ALL FLIR	GOOD	N/A	Provides temperature contrast on vehicles or building. May be obscured by urban terrain.
VS-17 PANEL	D	ALL	MARGINAL	N/A	Only visible during daylight. Easily obscured by structures.
CHEMICAL HEAT SOURCES	D/N	ALL FLIR	POOR	N/A	Easily masked by urban structures and lost in thermal clutter. Difficult to acquire, can be effective when used to contrast cold background or when a/c knows general location.
SPINNING CHEM- LIGHT (OVERT)	N	ALL	MARGINAL	N/A	Provides unique signature. May be obscured by structures. Provides a distinct signature easily recognized. Effectiveness dependent upon degree of urban lighting.
SPINNING CHEM- LIGHT (IR)	N	ALL NVD	MARGINAL	N/A	Provides unique signature. May be obscured by structures. Effectiveness dependent upon degree of urban lighting.

Table 10-6. Methods of marking friendly positions (continued).

10-16. ATTACK HELICOPTERS

The primary mission of attack helicopter units is to destroy armor and mechanized forces. Employing attack helicopters in combined arms operations increases the lethality of ground maneuver forces.

a. **Aircraft Characteristics.** The AH-64A Apache, the AH-64D Longbow Apache, the OH-58D Kiowa Warrior, and the AH-1W or AH-1Z (USMC) are employed in attack operations. Table 10-7 provides a comparison of the weapon systems and armaments on these attack helicopters. (The table also lists weaponry for the AH-1 Cobra, which is no longer in the active Army inventory but might be used to provide attack support in joint operations with US Marine units.)

AIRCRAFT TYPE	WEAPON SYSTEMS						
	Hellfire/TOW ¹	Air-to-Air Stinger	2.75-inch (70-mm) Rockets	Cal .50 MG (rds)	20-mm Cannon (rds)	30-mm Chain Gun (rds)	
AH-1 ²		8	76		750		
AH-64A ³	16		76			1,200	
AH-64D ³	⁴ 16	4	76			1,200	
OH-58D ^{2,3}	4	4	14	500			
AH-1W/Z ⁵							
Weapons Range (Max)	8 km	3,750 m	5+ km	8 km	2 km	2 km	4 km
Numbers in each column indicate the maximum load for each system. ¹ The AH-1 uses the TOW missile as its armor engagement weapon instead of the Hellfire missile. ² This aircraft carries one weapon system on each side (Hellfire, TOW, or both; air-to-air Stinger; and 2.75-inch rocket). ³ Aircraft has a laser for target designation and an ATHS. ⁴ Hellfire/Hellfire II. ⁵ USMC helicopters will have varied weapon loads. During coordination, request on-board weapon status.							

Table 10-7. Helicopter weapon systems.

b. **Close Combat Attack.** The close combat attack technique does not replace the integrated decision-making process between ground maneuver and aviation elements. It is a technique for directing lethal fires within the context of a preplanned mission.

(1) To request immediate close combat attack, the ground unit in contact executes a face-to-face coordination or uses a radio transmission to provide a situation update to the attack aircraft (METT-TC permitting). This situation update contains essential elements from the aviation close combat attack coordination checklist (Figure 10-4).

(2) After receipt of a request for immediate close combat attack, the attack team leader informs the ground unit leader of the battle position, attack-by-fire position, or the series of positions his team will occupy that will provide the best observation and fields of fire into the engagement or target area. The attack team leader then provides the ground maneuver unit leader with his concept for the team's attack on the objective.

(3) Upon mission completion, the attack team leader provides the ground maneuver commander a battle damage assessment (BDA) of the intended target.

CLOSE COMBAT ATTACK CHECKLIST

1. Enemy situation--specific target identification.
2. Friendly situation--location and method of marking friendly positions.
3. Ground maneuver mission/scheme of maneuver.
4. Attack aircraft scheme of maneuver.
5. Planned engagement area and BP/SBF position.
6. Method of target marking.
7. Fire coordination and fire restrictions.
8. Map graphics update.
9. Request for immediate aviation close fight support--used for targets of opportunity or for ground-to-air target handoff.

Figure 10-4. Close combat attack coordination checklist.

Section III. INTELLIGENCE

Intelligence (or knowledge) impacts directly on the effects of maneuver, firepower, protection, leadership, and information--the elements of combat power. It provides the information necessary to select when, where, and how to employ maneuver and firepower. Additionally, accurate intelligence provides the commander the necessary information to select appropriate protective measures essential to the security of the command.

10-17. INTELLIGENCE ASSETS.

The company (or platoon) may conduct operations with any of several types of intelligence assets. In stability and support operations, for example, interrogation or counterintelligence teams may work in DS of the company. While conducting security operations, the team may receive attached intelligence assets, such as ground surveillance radar (GSR) or improved remotely monitored battlefield sensor system (IREMBASS) teams. In most situations, however, attachment of intelligence assets to the company will be rare. More commonly, these assets will be operating in or near the company's area of operations; they will be attached to or in DS or GS of the battalion, brigade, or division.

10-18. INTELLIGENCE COORDINATION

The company (or platoon) should be prepared to take advantage of information from these assets. It may also be tasked to provide a degree of tactical and or logistical support, especially area medical support coverage, for the intelligence elements. In situations in which the company (or platoon) works with or supports intelligence assets, leaders of each element share responsibility for conducting coordination early in the operation. Coordination commonly includes exchanging call signs and frequencies, conducting fratricide prevention activities, and sharing basic operational plans, fire support plans, and fire control measures.

Section IV. MANEUVER SUPPORT

The antiarmor company (or platoon) may receive support from the engineer platoon supporting the battalion or from the assigned engineer company in the SBCT. The company may also receive support from air defense and nuclear, biological and chemical reconnaissance, smoke, and decontamination units supporting the higher headquarters.

10-19. ENGINEERS.

Engineer support will normally be limited to supporting mobility, countermobility, and survivability tasks due to the austere assets available to the company (or platoon). Sustainment engineering support is furnished from corps engineers or combat heavy (construction) engineer units that are task-organized to support the light infantry brigade or the SBCT. Engineer support to contingency operations is based on METT-TC analysis.

10-20. MOBILITY

At the tactical level, overmatching mobility is critical to the success of the force. Within this context, the emphasis of engineer integration across the force is on mobility operations. Due to the full-spectrum capability of the company and the increasingly nonlinear, asymmetric nature of the enemy, the potential exists for the company to encounter a wide variety of existing and reinforcing obstacles. To counter this potential threat, the company commander plans, organizes, and prepares to perform mounted and dismounted mobility tasks using the full range of organic and augmentation mobility assets.

a. **Breaching Operations.** Engineers reduce obstacles as part of company breaching operations (Table 10-8, page 10-24) and must be prepared to perform mounted and dismounted reduction tasks using manual, mechanical, and explosive reduction means. (See FM 3-34.2) Through reverse breach planning, the supporting engineer identifies critical mobility tasks, allocates reduction assets, and recommends a breaching task organization to the company commander. Keys to allocating reduction assets include identifying all reduction tasks within the zone or axis, matching specific reduction assets to each task, and planning 50 percent redundancy in reduction assets for each task. The breach force must have the capability to secure the breach site locally; therefore, an engineer-based breach force must be task-organized with adequate maneuver combat power to suppress enemy forces in the vicinity of the breach site. The assault force must have the capability to exploit the breach and continue the attack. The following are keys to synchronizing a breach through reverse planning:

- Actions on the objective drive the size of the assault force.
- The size of the assault force determines the number and types of breach lanes required.
- The number and types of breach lanes determine composition of the breach force.
- Suppression and obscuration required drives the size and composition of the support force.

BREACHING TENETS	BREACHING FUNDAMENTALS	BREACHING ORGANIZATION	TYPES OF BREACHING OPERATIONS
Intelligence	Suppress	Assault Force	Assault
Breaching Fundamentals	Obscure	Breach Force	Covert
Breaching Organization	Secure	Support Force	In-Stride
Mass	Reduce		Deliberate
Synchronization	Assault		

Table 10-8. Key breaching doctrine.

During the breach planning process, it is imperative that the company commander establishes clear commitment criteria for the breach force. The commitment criteria should be as specific and measurable as possible so that they are clear, executable, and reportable. Sub-unit instructions or SOPs should likewise be clear and concise and should cover all potential actions and reactions. Leaders must position to quickly assess the success of the force in setting the prescribed conditions. To ensure success, all units must perform detailed combined-arms breach rehearsals whether mounted or dismounted.

b. **Route Clearance Operations.** The nature of operations makes route clearance a likely task at all levels. Route clearance is a combined-arms operation normally assigned to an infantry battalion or company that is task-organized with engineers and other CS and CSS assets as required. As such, it requires the detailed integration and synchronization found in typical breaching operations. (For a detailed discussion of route clearance operations, refer to FMs 5-7-30, 20-32, and 5-71-2.)

c. **Mobility Planning in the Defense.** Mobility operations in the defense ensure the ability to reposition forces, delay, and counterattack. Because of the mobile, offensive nature of the force, mobility planning is a key component of any defensive scheme of maneuver. The commander analyzes the scheme of maneuver, obstacle plan, and terrain to determine mobility requirements. Critical considerations may include--

- Lanes and gaps in the obstacle plan.
- Lane closure plan and sub-unit responsibility.
- Route reconnaissance, improvement, and maintenance.

10-21. COUNTERMOBILITY

Due to the austere engineer force structure, the brigade or battalion engineer performs the majority of obstacle planning and provides detailed integration and resourcing information to the companies (or platoons) in the higher unit’s OPORD. He plans obstacles for both offensive and defensive operations. In either situation, the engineer uses obstacles to develop engagement areas, protect friendly vulnerabilities, and

counteract enemy reactions to friendly maneuver. Because of the mobile nature of the force and the inherently asymmetric, nonlinear environment in which it operates, the engineer relies primarily on scatterable, remotely delivered minefield systems to shape the battlefield. To the infantry company, this normally means integrating ground Volcano and MOPMS into the obstacle plan. The SBCT or battalion engineer designs and resources tactical obstacle groups, which companies integrate with direct and indirect fires and construct with engineer support. Obstacle groups consist of one or more individual obstacles that when integrated with direct and indirect fires achieve a specific effect (disrupt, fix, block, or turn). The obstacle plan must support the scheme of maneuver, maximize subordinate flexibility, and facilitate future operations.

a. **Obstacle Planning Process.** The obstacle planning process is an integral part of developing both offensive and defensive COAs. It correlates directly with sub-unit maneuver and positioning, engagement area development, and enemy actions. It includes these key components:

- Direct and indirect fires analysis.
- Obstacle intent integration (target, effect, relative location).
- Method of emplacement (conventional or scatterable).
- Obstacle effect priority.
- Mobility requirements.
- Obstacle design and resourcing.
- Marking and reporting obstacle locations.

b. **Barrier Material Resupply.** The higher unit S4 normally determines the method (in position or “tailgate”, out of position or “service station”, or supply point) and location for performing Class IV and V resupply during the MDMP. He provides resource quantities and tentative resupply node (Class IV and V point and mine dump) locations to companies in the OPORD. The company commanders then analyze resources and mine dump locations based on physical reconnaissance of their AO. The commander submits the results of this assessment to the S4 for adjustment as early as possible.

c. **Mine Dump Operations.** Mine dumps normally contain resources for a single obstacle group but may contain resources for individual obstacles if the distances between obstacles in a group are excessive and would potentially waste an inordinate amount of transportation time. The company commander, in coordination with the supporting engineer, locates the mine dump(s) where it best supports obstacle construction within the AO. If a company is assigned more than one obstacle group, it may have more than one mine dump. In light of the austere engineer organization within the force, it is imperative that the companies provide leadership and manpower to operate the mine dump, allowing engineers to construct tactical obstacles more efficiently. This requires close coordination with the supporting engineer.

d. **Obstacle Intent.** Obstacle intent provides a simple framework for the commander to issue guidance and facilitates common understanding and coordination between maneuver and engineer forces. It is at the foundation of the obstacle integration process and includes three components: target, obstacle effect, and relative location.

(1) The *target* is the enemy force that the commander wants to affect with fires and tactical obstacles. The commander identifies the target in terms of size, type, echelon, avenue of approach, or any combination.

(2) The *obstacle effect* (see Chapter 5, Defense) describes how the commander wants to attack enemy maneuver with obstacles and fires. Tactical obstacles block, turn, fix, or disrupt the enemy. The obstacle effect drives integration by focusing the relationship between obstacles and direct and indirect fires.

(3) The *relative location* is where the commander wants the obstacle effect to occur against the targeted enemy force. Whenever possible, the commander identifies the location relative to the terrain and maneuver or fire control measures to initiate the obstacle integration process.

e. **Scatterable Mines.** Scatterable mines (SCATMINEs) are remotely delivered or dispensed by aircraft, artillery, missile, or ground dispenser and are laid without pattern. All US SCATMINEs have a limited active life and self-destruct after that life has expired. The duration of the active life varies with the type of delivery system and mine. SCATMINEs provide the commander with a means to respond to a changing enemy situation with remotely delivered minefields. They enable the commander to emplace minefields rapidly in enemy-held territories, to close lanes in obstacles, and to emplace in other areas where it is difficult for engineers to emplace conventional minefields quickly.

(1) **SCATMINE Emplacement Authority.** The corps commander has emplacement authority for all scatterable minefields within the corps AO. He may delegate this authority to lower echelons according to the guidelines contained in Table 10-9.

SYSTEM CHARACTERISTICS	EMPLACEMENT AUTHORITY
Ground- or artillery-delivered, with SD time greater than 48 hours (long duration).	The corps commander may delegate emplacement authority to division level, which may further delegate to brigade level.
Ground- or artillery-delivered, with SD time of 48 hours or less (short duration)	The corps commander may delegate emplacement authority to division level, which may further delegate to brigade level (which may further delegate to battalion level).
Aircraft-delivered (Gator), regardless of SD time.	Emplacement authority is normally at corps, theater, or army command level, depending on who has air-tasking authority.
Helicopter-delivered (Volcano), regardless of SD time.	Emplacement authority is normally delegated no lower than the commander who has command authority over the emplacing aircraft.
MOPMS when used strictly for a protective minefield.	Emplacement authority is usually granted to the company or base commander. Commanders at higher levels restrict MOPMS use only as necessary to support their operations.

Table 10-9. Emplacement authority.

(2) **Scatterable Minefield Warning.** The executing unit sends a scatterable minefield warning (SCATMINWARN) to all affected units before, or immediately after, the emplacement of the minefield (Table 10-10). The SCATMINWARN should be disseminated over command nets at all levels to all units operating in the area of the minefield during current and future operations. Absolutely critical components of the SCATMINWARN include the cornerpoint locations, size of safety zone, and self-destruct time.

Line	Message
Alpha	Emplacing system
Bravo	AT (Yes or No)
Charlie	AP (Yes or No)
Delta	4 aim or corner points
Echo	Grid coordinates of aim points/corner points and size of the safety zone
Foxtrot	DTG of the life cycle

Table 10-10. SCATMINEWARN.

(3) **SCATMINE Delivery Systems.**

(a) *Area-Denial Artillery Munitions (Field Artillery Delivered).* The wedge-shaped ADAM is a bounding-fragmentation mine that deploys up to seven tension-activated trip wires 6 meters away from the mine. After ground impact, trip wires are released and the mine is fully armed. The lethal casualty radius is between 6 and 10 meters.

(b) *Remote Antiarmor Mines (Field Artillery Delivered).* The RAAM mine has a cylindrical shape and provides a full-width or catastrophic kill. Using a magnetically influenced fuse, the mine projects a bi-directional, shaped-charge warhead through the crew compartment of a vehicle.

(c) *Multiple Delivery Mine System, or Volcano (Ground or Air Delivered).* The Volcano is mounted on a cargo truck, UH-60A Blackhawk helicopter or an engineer squad vehicle (ESV). The Volcano dispenses mines with 4-hour, 48-hour, and 15-day self-destruct (SD) times. The SD times are field-selectable before dispensing and do not require a change or modification to the mine canister. Reload time (not including movement time to the reload site) for an experienced four-man crew is approximately 20 minutes. The average time to emplace one ground Volcano load (160 canisters) is 10 minutes.

(d) *Modular Pack Mine System (Man-Portable).* The MOPMS is a man-portable, 162-pound, suitcase-shaped mine dispenser. The dispenser contains 21 mines (17 antitank [AT] and 4 antipersonnel [AP]). When dispensed, an explosive propelling charge at the bottom of each tube expels mines through the container roof. Mines are propelled 35 meters from the container in a 180-degree semicircle. The safety zone around one container is 55 meters to the front and sides and 20 meters to the rear. Mines are dispensed on command using an M71 remote-control unit (RCU) or an electronic initiating device with firing wire. Once mines are dispensed, they cannot be recovered or reused. If mines are not dispensed, the container may be disarmed and recovered for later use. The RCU can recycle the 4-hour SD time of the mines three times, for a total duration of approximately 13 hours. The RCU can also self-destruct mines on command, allowing a unit to counterattack or withdraw through the minefield. The RCU can control up to 15 MOPMS containers or groups of MOPMS containers from a distance of 300 to 1,000 meters.

(e) *Raptor/Hornet (Man-Portable).* The Raptor/Hornet wide area mine introduces an entirely new obstacle concept to the combined-arms team. The Raptor/Hornet is an integrated C2/top-attack special munition that type-categorizes, reports, and engages individual vehicles (Figure 10-5, page 10-28). The Raptor is a “smart” remote combat outpost that can provide the force with near-real-time situational understanding and can

command and control multiple Hornet mines in a fully integrated obstacle network. It can be programmed to command and control coordinated attacks with other Raptor-controlled minefields or with direct and indirect fire weapons systems. The Raptor/Hornet can be deactivated, allowing freedom of maneuver through the minefield while still providing near-real-time intelligence and situational understanding. The Raptor/Hornet has standoff detection and engagement capabilities. It attacks from the side or top at ranges up to 100 meters. The Raptor/Hornet--

- Can be a stand-alone tactical obstacle or can reinforce other conventional obstacles.
- Disrupts and delays the enemy, allowing long-range, precision weapons to engage more effectively. (This feature is particularly effective in non-LOS engagements.)
- Can communicate with its employing unit for remote on/off/on or program and battlespace intelligence reporting. The battlespace intelligence data may include target descriptions, numbers, and the direction and rate of movement. It can also provide an early warning of the enemy's activity.
- Can communicate with other munitions for conducting coordinated attacks.

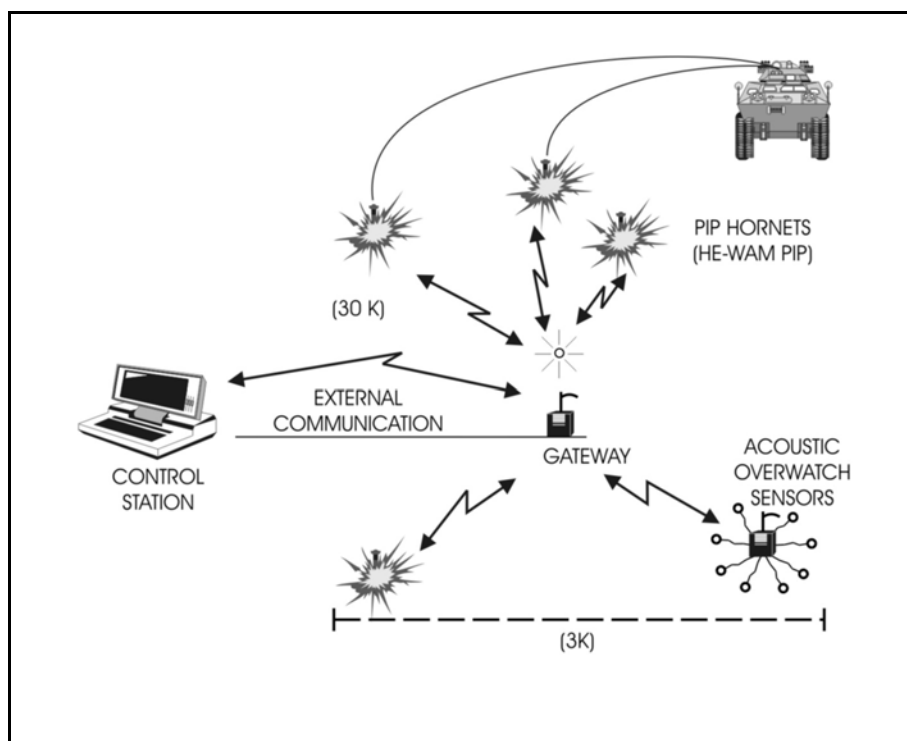

Figure 10-5. Raptor/Hornet concept.

(4) **SCATMINE Marking.** The emplacing unit is responsible for marking a scatterable minefield (Figure 10-6). This requires direct coordination between the owning maneuver unit and the delivering or emplacing unit. This requirement specifically applies to MOPMS, Volcano (ground-delivered), and Raptor/Hornet minefields. Minefields should be marked on four sides if emplaced to the rear of any friendly unit, including

reconnaissance elements and other units that may require a rearward passage of lines (RPOL).

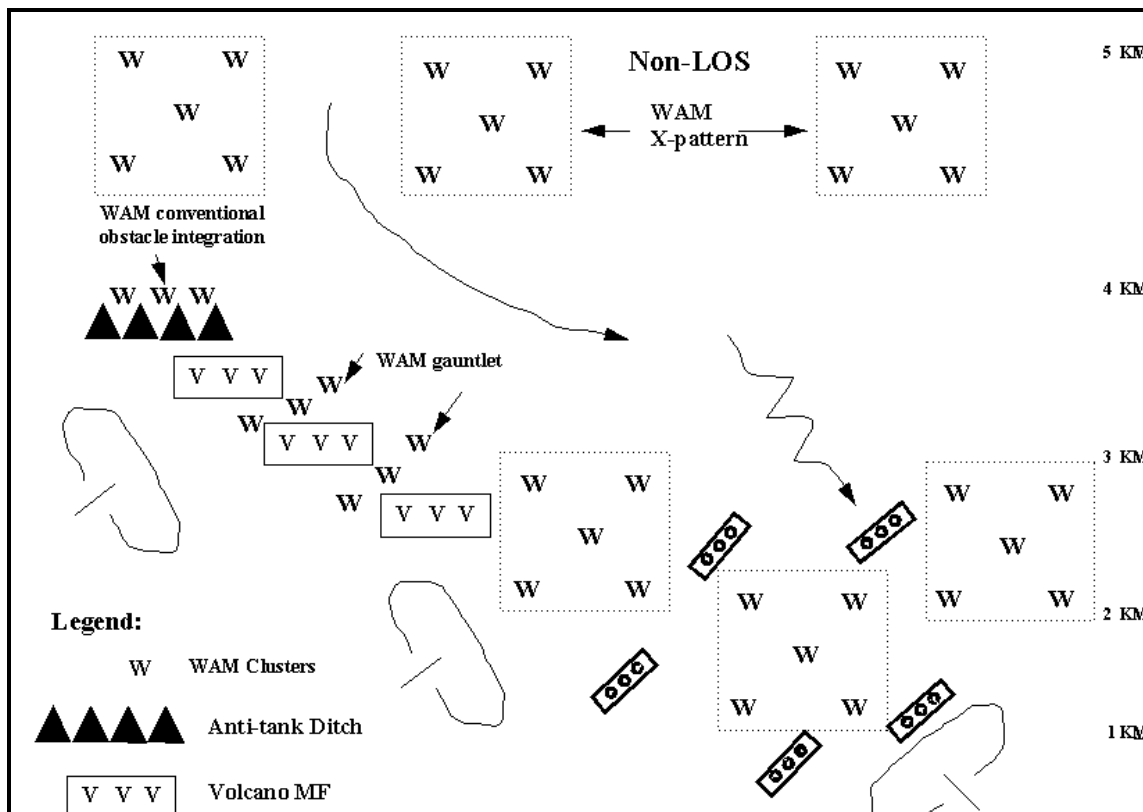

Figure 10-6. SCATMINE marking.

(a) *Safety Zones.* A safety zone is the area outside of the planned dimensions of a scatterable minefield where mines may land and activate. The commander must prevent friendly forces from maneuvering into the safety zone during the minefield's life cycle. Depending on its specific location on the battlefield, the safety zone may be marked with a fence.

(b) *Fragment Hazard Zones.* If a scatterable antiarmor mine lands and activates on its side and self-destructs, the resulting detonation may cause the shaped-charge to travel along a horizontal trajectory. The maximum fragment hazard zone for all US SCATMINE systems is approximately 640 meters. However, the acceptable risk distance is 235 meters from the outer edges of the minefield's safety zone for troops in the open (Table 10-11, page 10-30).

System	Safety Zone	Fragment Hazard Zone
ADAM/RAAM	500 to 1,500 meters from aim point(s) (depends on delivery method)	235 meters from the outside dimensions of the safety zone
Gator	925 x 475 meters from aim point(s)	1,395 x 945 meters from aim point(s)
Ground Volcano	1,150 x 160 meters	235 meters from start and stop points and the center line
Air Volcano	1,915 x 200 meters	235 meters from start and stop points and the center line
MOPMS	See FM 20-32, Figures 3-15 through 3-17, for specific placement.	235 meters from the outside dimensions of the safety zone

Table 10-11. Safety and fragment hazard zones.

10-22. SURVIVABILITY

Survivability operations protect the force. The company commander (or platoon leader) plans, prioritizes, and enforces the survivability effort. The plan should specify the following:

- Level of survivability for each sub-unit position.
- Priority of survivability support by specific unit, type of weapon system, or combination.
- Type of position to be dug for a unit or type of system.
- Sequence and time allocated for platoons to receive blade support.

Additional considerations for survivability planning include command and control of digging assets, site security, CSS (fuel, maintenance, and Class I), and movement times between BPs. The commander should start the survivability effort as soon as practical. He may employ blade assets to support systems such as mortars, C2, and key weapons before the bulk of his combat systems are ready for survivability support. The commander should establish a directed time to be ready for survivability (or a “not later than [NLT]” time) to prevent waste of blade time. Companies prepare their area for the arrival of the blades by marking vehicle positions, identifying leaders to supervise position construction, and designating guides for the blade movement between positions.

10-23. NBC SUPPORT

Nuclear, biological, and chemical assets within a battalion (or the SBCT) are limited; therefore, it is imperative that the company (platoon) practice the fundamentals of NBC defense, avoidance, protection, and decontamination in order to survive on a contaminated battlefield.

a. **NBC Reconnaissance Support.** The corps or divisional chemical company (or the NBC reconnaissance platoon organic to the RSTA squadron of the SBCT) provides reconnaissance support. The NBC reconnaissance platoon can locate, identify, and mark areas of contamination. Since NBC reconnaissance assets are limited, the company commander (or platoon leader) must plan for alternate means of conducting NBC reconnaissance.

b. **Decontamination Support.** Operational decontamination support is not available at the company level. For operational decontamination, the company (or platoon) must request support from the battalion decontamination team. Thorough decontamination operations require the support of an external decontamination platoon. The company (or

platoon) must request this support through the higher headquarters' S3 section. The contaminated unit will be tasked to augment the decontamination platoon during the conduct of thorough decontamination operations. (For a more detailed discussion of decontamination requirements, refer to FM 3-5.)

c. **Smoke Support.** Internal smoke capabilities consist of company mortars and smoke pots. Smoke pots are the commander's primary means of producing small-area screening smoke. An external smoke platoon is required for long-term, large-area obscuration. If attached, the smoke platoon has the capability of providing both hasty smoke and large-area smoke support for tactical operations in the main battle area.

d. **Preparedness.** Because of the capability of a growing number of nations to employ nuclear and chemical weapons and the apparent willingness of some nations to use them, the company must plan from the outset to fight in an NBC environment. The commander is responsible for preparing his unit to operate in an NBC environment. He does this by--

- Continuing normal operations but reducing his unit's vulnerability through terrain shielding and increased protective measures while positioning elements to accomplish the mission.
- Specifying a level of protection that will reduce the risk of mass casualties when faced with an NBC threat.

Section V. AIR DEFENSE ARTILLERY

Stinger man-portable air defense system (MANPADS) teams, Avengers, Bradley Linebackers, and Bradley Stinger Fighting Vehicles (BSFVs) may operate in and around the company AO in support of the battalion or brigade. It is unlikely that the antiarmor company will be task-organized with any of these air defense assets. Therefore, the company must conduct its own air defense operations, relying on disciplined passive air defense measures and the ability to actively engage aerial platforms with organic weapons systems.

10-24. SYSTEMS, ORGANIZATION, AND CAPABILITIES

The systems that may operate in and adjacent to the company AO are Stinger MANPADS and the Avenger, Linebacker, and BSFV (Table 10-12, page 10-32). The Avenger, BSFV and Linebacker systems can operate as Stinger MANPADS teams. The battalion is normally task-organized with an air defense platoon equipped with MANPADS- or Avenger-equipped units. Linebacker- or BSFV-equipped units may be present if the battalion (or SBCT) is fighting as part of a heavy organization. The company may have an air defense section moving with it; however, this section normally remains part of the air defense platoon, responsible for providing DS or GS coverage to higher units.



<p style="text-align: center;">Man-Portable System</p> 	<p>Personnel: 2-man crew Basic load: 6 missiles basic load w/ M998 HMMWV Acquisition/range: Visual Engagement range: 5 km Engagement altitude: 3 km + Mutual support: 2 km +</p>
<p style="text-align: center;">Avenger</p> 	<p>Personnel: 2 man crew Basic load: 8 ready-to-fire missiles, 250 rds .50 cal Acquisition/range: Visual/FLIR 9-10 km, laser range finder Engagement range: 5 km + Engagement altitude: 3 km + Mutual support: 3 km Emplacement time: 6 min, can remote operations out to 50 meters</p>
<p style="text-align: center;">Bradley Linebacker</p> 	<p>Personnel: 4-man crew Basic load: 10 missiles (4 ready to fire, 6 stowed) Acquisition/range: Visual/thermal Engagement range: 5 km (Stinger), 2500 m 25-mm, 900 m coax Engagement altitude: 3 km + Mutual support: 3 km Emplacement time: Fire on the move Reload time: 4 minutes</p>
<p style="text-align: center;">Bradley Stinger Fighting Vehicle</p> 	<p>Personnel: 5-man crew Basic load: 6 Stinger; 5 TOW, 900 25-mm (300 RTF) Acquisition/range: Visual/IR Engagement range: 5 km (Stinger), 3750 m (TOW), 2500 m 25-mm, 900 m coax Engagement altitude: 3 km + Mutual support: 3 km Emplacement time: 10 sec (hasty), 6 min (deliberate)</p>

Table 10-12. Air defense systems.

10-25. EMPLOYMENT OF AIR DEFENSE SYSTEMS

In offensive situations, AD elements accompany the main attack. They may maneuver with the brigade or battalion's lead company, orienting on low-altitude air avenues of approach. When the unit is moving or in a situation that entails short halts, the short range air defense (SHORAD) element positions its vehicles and MANPADS to assure mutual support between systems and coverage to the company. The Stinger gunners can dismount to provide air defense when the unit reaches the objective or pauses during the attack. In the defense, SHORAD units establish battle positions based on available information and the battalion and or brigade commander's scheme of maneuver. Squads are positioned approximately 2 kilometers apart to maximize the air defense vehicles' defensive capabilities.

10-26. WEAPONS CONTROL STATUS

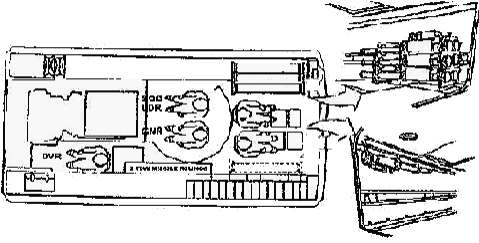
The weapons control status (WCS) describes the relative degree of control in effect for air defense fires. It applies to all weapons systems. The weapons control status is dictated in the higher unit's OPOD and may be updated based on the situation. There are three levels of weapons control.

a. **Weapons Free.** Crews can fire at any air target not positively identified as friendly. This is the least restrictive weapons control status level.

b. **Weapons Tight.** Crews can fire only at air targets positively identified as hostile according to the prevailing hostile criteria.

c. **Weapons Hold.** Crews are prohibited from firing except in self-defense or in response to a formal order. This is the most restrictive control status level.

10-27. EARLY WARNING PROCEDURES

Air defense warnings (ADWs) include--

- RED--Air or missile attack imminent or in progress.
- YELLOW--Air or missile attack probable.
- WHITE--Air or missile attack not likely.

While air defense warnings cover the probability of hostile air action over the entire theater of war or operations, local air defense warnings describe with certainty the air threat for a specific part of the battlefield. Air defense units use these local warnings to alert Army units to the state of the air threat in terms of "right here, right now." There are three local air defense warning levels:

- DYNAMITE--Air platforms are inbound or are attacking locally now.
- LOOKOUT--Air platforms are in the area of interest but are not threatening. They may be inbound, but there is time to react.
- SNOWMAN--No air platforms pose a threat at this time.

NOTE: The area air defense commander routinely issues air defense warnings for dissemination throughout the theater of war or operations. These warnings describe the general state of the probable air threat and apply to the entire area.

10-28. REACTION PROCEDURES

Reaction procedures include both passive and active air defense measures.

a. **Passive Air Defense.** Passive air defense consists of all measures taken to prevent the enemy from detecting or locating the unit, to minimize the target acquisition capability of enemy aircraft, and to limit damage to the unit if it comes under air attack. One advantage the company can exploit is that target detection and acquisition are difficult for crews of high-performance aircraft. In most cases, enemy pilots must be able to see and identify a target before they can launch an attack.

(1) **Guidelines.** The company (or platoon) should follow these guidelines to avoid detection or limit damage:

- When stopped, occupy positions that offer cover and concealment; dig in and camouflage vehicles that are exposed. When moving, use covered and concealed routes.
- Disperse vehicles as much as possible to make detection and attack more difficult.
- Wipe out track marks leading to vehicle positions and eliminate or cover the spoil from dug-in positions.
- If moving when an enemy aircraft attacks, disperse and seek covered and concealed positions.
- Do not fire on a hostile fixed-wing aircraft unless it is clear that the aircraft has identified friendly elements. Premature engagement compromises friendly positions.
- Designate air guards for every vehicle and position; establish and maintain 360-degree security.
- Establish an air warning system in the unit SOP, including both visual and audio signals.

(2) **Procedures.** When the company observes fixed-wing aircraft, helicopters, or UAVs that could influence its mission, it initially takes passive air defense measures unless the situation requires immediate active measures. This reaction normally takes the form of each platoon's React to Air Attack Battle Drill; however, the commander can initiate specific passive measures if necessary. Refer to the passive air defense guidelines for the company team discussed earlier in this section. Passive air defense involves these three steps:

- Step 1--Alert the unit with a contact report.
- Step 2--Deploy or take the appropriate actions. If the unit is not in the direct path of an attacking aircraft, the commander (or platoon leader) orders vehicles to seek cover and concealment and halt with at least a 100-meter interval between vehicles. The unit also may be ordered to continue moving as part of the higher organization.
- Step 3--Prepare to engage. Vehicle crews prepare to engage the aircraft with machine-gun or main-gun fire on order of the commander or their platoon leader.

NOTE: Passive air defense also includes the unit's preparations for conducting active air defense measures.

b. **Active Air Defense.** If the commander (or platoon leader) determines that the unit is in the direct path of attacking aircraft, he initiates active air defense procedures, including React to Air Attack drills by the subordinate units. Active air defense entails the following steps:

- Step 1--Initiate fires. The primary intent is to force aircraft to take self-defense measures that alter their attack profile and reduce their effectiveness. Leaders may use a tracer burst to designate an aim point for machine gun antiaircraft fires (Figure 10-7). Volume is the key to effectiveness; crew-served and individual weapons throw up a "wall of steel" through which aircraft must fly. Antiarmor weapon system employment (TOW and Javelin) provides effective air defense against hovering attack helicopters
- Step 2--Create a nonlinear target. Vehicles move as fast as possible at a 45-degree angle away from the path of flight and toward attacking aircraft. Each platoon maintains an interval of at least 100 meters between vehicles, forcing aircraft to make several passes to engage the entire platoon.
- Step 3--Move quickly to covered and concealed positions and stop. Vehicles freeze their movement for at least 60 seconds after the last flight of aircraft has passed.
- Step 4--Send a spot report (SPOTREP). The company commander or XO (platoon leader or platoon sergeant) updates the higher commander on the situation as soon as possible.

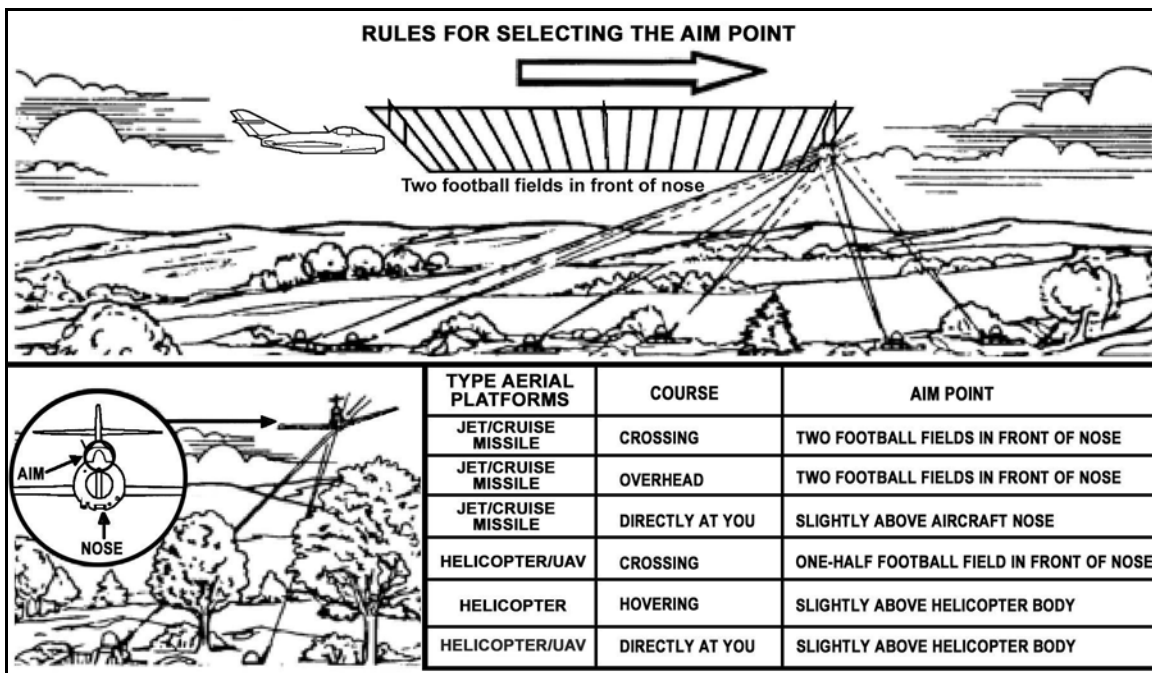

Figure 10-7. Machine gun aim points against helicopters and high-performance aircraft.

Section VI. COMBAT SUPPORT IN THE STRYKER BRIGADE COMBAT TEAM.

The SBCT and its battalions, squadron, or other supporting units provide the SBCT antiarmor company with combat support. Support can include fires from an infantry battalion mortar platoon or reconnaissance troop mortar section, or fires from field artillery, and tactical aircraft. The SBCT RSTA squadron and engineer company or the infantry battalion reconnaissance platoon may also support an antiarmor unit.

10-29. SBCT

The SBCT is a full-spectrum-capable combat brigade. The SBCT is organized with assigned unit-based capabilities--military intelligence, RSTA, engineer, artillery, and signal.

a. Reconnaissance, Surveillance, and Target Acquisition Squadron. The RSTA squadron answers the brigade commander's PIR, fills voids in information, and helps a commander to develop understanding within the area of operations by serving as a primary source of combat information. The squadron contains three reconnaissance troops, each of which includes Javelins and a 120-mm mortar section. The squadron's surveillance troop incorporates a UAV platoon, a multi-sensor platoon, signal intelligence and ground sensor, and an NBC reconnaissance platoon. The squadron can simultaneously reconnoiter nine routes or conduct surveillance of 18 named areas of interest on a continuous 24-hour cycle.

b. Field Artillery Battalion. The SBCT has an assigned field artillery battalion. Three batteries of M-198 towed 155-mm artillery provide the brigade with fire support. Each battery has four guns assigned for a total of 12 artillery pieces in the SBCT.

c. Engineer Company. The engineer company serves as the SBCT's primary means for mobility. Contingencies requiring survivability and construction will require the SBCT to be augmented with additional engineer assets. The company consists of three line platoons and one support platoon.

d. Military Intelligence Company. The military intelligence company (MICO) provides analysis and ISR analysis integration functions to support the development of the SBCT commander's common operational picture (COP), targeting and effects, and IPB. It operates as an extension of the SBCT S2 staff for the management of internal and external collection assets.

10-30. INFANTRY BATTALION

The antiarmor company may be attached or OPCON to an infantry battalion. The infantry battalion mortar platoon responds to support requests from the companies according to the battalion fire plan. The battalion reconnaissance platoon and snipers normally work directly for the battalion; however, at times they may operate in the antiarmor company's AO.

a. Battalion Mortars. The company receives supporting fires from the battalion mortars. The battalion order designates the priority of fires and allocates priority targets. The company commander considers his priority within the battalion plan. If he is first in priority, his calls for fire take precedence over all other battalion units. This may allow the commander to depend less on the field artillery battalion. Also, the company commander must understand the risks involved; for example, the priority of fires may

change. The infantry battalion commander should be aware that the antiarmor company has no assigned mortars, but has a fire support vehicle (FSV) equipped with a G/VLLD. If a priority target is allocated to the company, the company commander plans to employ it when and where it will be most useful to achieve the desired effects.

b. **Battalion Reconnaissance Platoon.** The battalion reconnaissance platoon is organized and equipped for reconnaissance--not to seize or retain terrain. Its primary missions are to reconnoiter and screen. When the reconnaissance platoon is operating near the antiarmor company, the commander may communicate with the platoon leader via FM, FBCB2, or he may use visual signals. Necessary signals and contact procedures are arranged between the antiarmor company commander and the reconnaissance platoon leader. If reconnaissance elements must pass through the company (or vice versa), contact points, passage points, passage lanes, guides, and procedures must be arranged. The reconnaissance platoon may be attached to the company for a counterreconnaissance mission. The reconnaissance teams serve as the commander's eyes and ears on the battlefield. They provide continuous battlefield information on operations; they should only use their organic weapons in self-defense.

c. **Battalion Snipers.** Snipers may operate in support of the antiarmor company for specific missions. They are most effective when tasked to destroy specific enemy targets and when allowed to operate with few restrictions.

CHAPTER 11

COMBAT SERVICE SUPPORT OPERATIONS

The role of combat service support in any military unit is to sustain the force for continuous combat operations. At company level, regardless of the type battalion or brigade, the company commander has ultimate responsibility for CSS. The executive officer, the first sergeant, platoon leaders, and platoon sergeants are the primary CSS operators for the antiarmor company. The light infantry battalion's antiarmor platoon is supported logistically by the battalion headquarters company 1SG or XO, or the combat trains command post. The SBCT antiarmor company CSS operations are discussed in Section VII. Only the significant differences in combat service support to the SBCT antiarmor company will be addressed.

Section I. AIRBORNE, AIR ASSAULT, AND LIGHT INFANTRY BATTALION CSS

Combat service support requirements range from sustaining platoons and companies operating independently to sustaining battalions operating in restrictive terrain with little or no access by road. Requirements for CSS vary, depending on the unit mission. Commanders, mainly through their XOs, S4s, and S1s, plan and employ CSS assets to ensure success of missions. The constraints inherent in the CSS organization require infantry commanders to rely on their ingenuity, endurance, and initiative to succeed in rugged environments.

11-1. DEVELOPMENT OF THE CSS PLAN

The infantry battalion commander, battalion S4, and antiarmor company commander (or platoon leader) plan and implement antiarmor CSS operations. A CSS team, consisting of the infantry battalion S4, battalion support platoon leader, company XO, company 1SG, company supply sergeant, antiarmor platoon sergeants, and antiarmor squad leaders, implements antiarmor company CSS plans. Antiarmor leaders plan and make CSS decisions to accomplish their assigned missions according to guidance from higher headquarters and SOPs. Unit SOPs should address planning, implementation, and responsibilities in detail and should standardize as many routine CSS operations as possible.

11-2. GENERAL GUIDELINES

In infantry battalions, CSS assets are assigned to the headquarters and headquarters company (HHC). The HHC commander then provides each maneuver company with personnel, equipment, supplies, and other support functions, including petroleum, oils, and lubricants (POL) and transportation requirements. The battalion sets the resupply schedule (usually by SOP) and organizes the logistic package (LOGPAC) to support the battalion. The light infantry battalion's antiarmor platoon is supported by a LOGPAC controlled by the HHC 1SG or XO.

a. Within this support structure, the antiarmor company (or platoon) must plan, prepare, and execute its portion of the CSS plan. Concurrent with other operational

planning, the antiarmor unit develops its CSS plan during mission analysis and refines it when war-gaming courses of action. CSS rehearsals are normally conducted at both battalion and company levels to ensure a smooth, continuous flow of materiel and services.

b. The antiarmor company's (or platoon's) basic CSS responsibilities are to report requirements and request support through the appropriate logistical channel, and to ensure that CSS operations are properly executed when support elements arrive in the company area. The antiarmor company 1SG or XO is normally in charge of these functions, with guidance and oversight provided by the antiarmor company commander. They must submit accurate personnel and logistical reports, along with other necessary information and requests.

11-3. RESPONSIBILITIES

The antiarmor company commander is responsible for the coordination and execution of CSS functions within the company. This includes reporting current status, requesting supplies or support, and conducting effective CSS operations within the unit. The primary CSS functions required by the company include CASEVAC, resupply operations, maintenance activities, and personnel service support. The following company and platoon personnel have CSS responsibilities.

a. **Company Commander.** The company commander ensures that CSS operations sustain his antiarmor company's fighting potential. He integrates CSS activities into the tactical plan and provides guidance to the CSS operators. He tailors his CSS operations to meet the tactical plan.

b. **Company Executive Officer.** The company XO, in addition to his tactical responsibilities, coordinates and supervises the company's logistical effort. During planning, the company XO receives status reports from the platoon leaders, platoon sergeants, and 1SG; he reviews the tactical plan with the company commander to determine company CSS requirements; and he coordinates the company's needs with the battalion S4. During execution, the company XO is at the second most important place on the battlefield, as determined by the antiarmor company commander. The XO also performs the following CSS functions:

- Determines the location of the company's resupply point based on data developed during operational planning and the war-gaming process.
- Compiles periodic maintenance updates from the platoon leaders, the platoon sergeants, and the 1SG and provides updates to the antiarmor company commander as required.
- Along with the 1SG, ensures that the company is executing CSS operations IAW the battalion's plan and SOP.
- Ensures the CSS meets the needs of attached or OPCON units.

c. **First Sergeant.** The 1SG is the primary CSS operator for the company. He executes the company CSS plan and supervises the company trains. He makes sure the company XO and battalion CTCP receive current status reports from all subordinate units; he helps the company XO prepare reports and requests to battalion (or does this by himself); and he helps the company XO or company commander prepare paragraph 4 of the OPORD.

(1) The 1SG receives, consolidates, and forwards all logistics, personnel, and casualty reports to the CTCP. He supervises the CASEVAC, evacuation of EPWs, and the evacuation of damaged equipment. He also establishes and supervises company resupply

activities and monitors company maintenance activities.

(2) The 1SG orients new replacements and assigns them to antiarmor squads and antiarmor platoons IAW the company commander's guidance.

(3) The 1SG gets his information from the platoon sergeants and squad leaders as well as the senior medic. These NCOs are responsible for providing all CSS reports IAW the antiarmor company and battalion SOP.

(4) The 1SG also performs the following CSS functions:

- Conducts company level CSS rehearsals; integrates CSS operations into the company maneuver rehearsals.
- Receives, consolidates, and forwards all administrative, personnel, and casualty reports to the battalion combat trains.
- Directs and supervises the medical team and moves it forward when the situation requires.
- Maintains the company battle roster.

d. **Supply Sergeant.** The supply sergeant is the company representative in the battalion field trains.

(1) He assembles the LOGPAC and moves it forward to the company. He assists the 1SG with resupply and coordinates the company's CSS requirements with the battalion support platoon leader, battalion S4, and the HHC commander. The supply sergeant may control the medical ambulance when it is unable to remain forward with the antiarmor company. He monitors the tactical situation and adjusts the CSS plan as appropriate to meet the tactical plan and the company commander's intent. He forecasts the company's consumption of food, water, ammunition, and batteries, based on the operation.

(2) The supply sergeant also performs the following CSS functions:

- Coordinates with the battalion support platoon leader for resupply of Class I, III, and V.
- Maintains individual supply and clothing records and requisitions Class II resupply as needed.
- Requisitions Class IV barrier and construction materials.
- Coordinates with the battalion prescribed load list (PLL) section to turn in and pick up maintenance documents, routine Class IX supplies, and recoverable materials.
- Picks up replacement personnel and delivers them to the 1SG.
- Receives and evacuates all killed in action (KIAs) to the mortuary affairs point in the brigade support area (BSA).
- Transports, guards, and transfers EPWs as required.
- Guides the LOGPAC, along with EPWs and damaged vehicles (if applicable), back to the BSA.
- Coordinates with the battalion S1 section to turn in and pick up mail and personnel action documents.
- Collects bagged contaminated soil and transports it to collection points as part of LOGPAC procedures.
- Maintains and provides supplies for company field sanitation activities.

e. **Platoon Sergeant.** Each PSG in the company performs the following CSS functions:

- Ensures crews and or squads perform proper maintenance on all assigned equipment.
- Compiles all personnel reports and logistics reports for the platoon and submits them to the 1SG as directed or in accordance with SOP.
- Collects each DA Form 2404 within the platoon.
- Obtains supplies and equipment (all classes except Class VIII) and mail from the supply sergeant and ensures proper distribution within the platoon.

f. **Senior Medic.** The antiarmor company's senior medic and other medics are assigned to the HHC, but are attached to the company. The senior medic's responsibilities include the following:

- Supervising triage for injured, wounded, and ill personnel (friendly and enemy).
- Providing first aid for and stabilizing injured, wounded, or ill personnel.
- Under the direction of the 1SG, evacuating those who are seriously wounded.
- Supervising the antiarmor company's field sanitation team.
- Conducting sick call as required.
- Assisting with training company personnel in first-aid procedures.
- Advising the company chain of command on the health status of personnel and other health concerns.
- Requisitioning Class VIII supplies, including combat lifesaver bags and first-aid kits, for the medical team and other company elements.
- Recommending locations for casualty collection points.
- Supervising the company's combat lifesavers and field sanitation team.

Section II. TRAINS

In order to meet the intent of both the brigade and battalion commanders (two levels up), each organization at the antiarmor company level and higher must have a logistical focal point. This focal point is generally described as the "trains." The types of logistical trains are described in this section.

11-4. BATTALION COMBAT TRAINS

The battalion combat trains are normally positioned close enough to the FLOT to be responsive to forward units but beyond the range of enemy direct fires. The trains are positioned based upon the factors of METT-TC.

11-5. BATTALION FIELD TRAINS

The battalion field trains are normally positioned in the brigade support area. The antiarmor company, with the other maneuver companies, normally locates its supply section and any corresponding vehicles in the battalion field trains.

11-6. COMPANY TRAINS

The most forward CSS element is the company trains, which provide vehicle recovery, medical aid, and maintenance services. It is the focal point for company sustainment operations. The size, composition, and location of the company trains vary depending upon an analysis of the factors of METT-TC. The trains normally operate one terrain feature to the rear of the company. This gives the antiarmor company virtually immediate access to essential CSS functions while allowing the trains to remain in a covered and concealed

position. The antiarmor company commander must consider the required security of his trains and the size of the force he plans to use. The ISG normally positions the trains and directly supervises CSS operations.

11-7. TRAINS SECURITY

Because security of CSS elements is critical to the success of the company missions, the company commander must develop plans for continuous security operations. Where feasible, the commander may plan and execute a perimeter defense. The trains, however, may lack the personnel and combat power to conduct a major security effort. In such situations, they must plan and implement passive security measures to provide protection from enemy forces.

11-8. COMMUNICATIONS

Fast, reliable communications are critical to the CSS effort. Whether as directed by higher headquarters or as needed to support the antiarmor company mission, the ISG must be able to instantly report the company's status, including combat losses, and to send resupply and support requests. In the light infantry battalion, the antiarmor platoon sergeant performs this same function.

a. As in all tactical situations, FM radio and FBCB2 are the fastest and most frequently used means for transmitting CSS requests and reports. The battalion administration and logistics (A/L) net is used for most CSS traffic, but the company may not have enough authorized FM radio systems to monitor it. When this is the case, a higher NCS must enter the company net to contact the company. Another type of problem can arise when a company enters the A/L net. The transmission of one company may transmit over another company's report or request. Unit SOPs must specify procedures to be followed in this type of situation to ensure that the battalion field and combat trains receive all transmissions on a timely basis. Units equipped with FBCB2 (for example, an SBCT) can transmit logistics reports digitally.

b. As an alternative, the company can send CSS reports and requests by messenger or wire. Messengers are slower than FM radio transmission, but more secure. Wire communications are also very secure, but are strictly limited in range and coverage. In situations where use of the FM radio communications is not possible, a messenger can be sent with the resupply or evacuation vehicle. For sending lengthy or complex reports and requests, messenger or wire (or digital message) is better than FM radio transmission.

Section III. RESUPPLY OPERATIONS

The antiarmor company commander considers the factors of METT-TC in determining the best means of resupplying his company. Resupply operations are generally classified as routine, emergency, or prestock (or cache). Cues and procedures for each method should be specified in a company SOP and must be rehearsed.

11-9. CLASSES OF SUPPLY

Figure 11-1, page 11-7, shows the classes of supply.

a. **Class I.** Class I includes rations, water, and ice as well as gratuitous issue items related to health, morale, and welfare. Class I supplies are automatically requested from the battalion on the daily strength report. Rations are prepared in the field trains and delivered

with the LOGPAC. Meals, ready to eat (MREs) stored on the antiarmor company or its platoon's vehicles are eaten only when Class I resupply, including mess operations, cannot be accomplished.

b. **Class II.** Class II includes clothing, individual equipment, MOPP suits, tentage, tool sets, and administrative and housekeeping supplies and equipment. Expendable items such as soap, toilet tissue, and insecticide are distributed during LOGPAC operations.

c. **Class III.** Class III covers POL products. Class III requests normally are submitted to the combat trains. POL includes both bulk and package products. Examples of bulk products include fuel such as Army common fuel (JP8) and motor gas (MOGAS). Package products (oil and lubricants) are requested and received like Class II and Class IV items.

d. **Class IV.** Among the items in Class IV are construction materials, pickets, sandbags, and concertina wire. Company SOP specifies the combat load of Class IV items for each vehicle.

e. **Class V.** Class V covers all types of ammunition and mines, including explosives such as C4.

f. **Class VI.** Class VI includes personal-demand items ordinarily sold through the exchange system. Examples are candy, soaps, cameras, and film. When a PX is not available, Class VI support is requested through the battalion S1.

g. **Class VII.** This supply class includes major end items such as vehicles. Class VII items are issued based on battle loss reports. Ready-to-fight weapons systems are sent forward with the LOGPAC.

h. **Class VIII.** Class VIII covers medical supplies. Combat lifesaver bags and first-aid kits are replaced on a one-for-one basis at the battalion aid station (BAS).

i. **Class IX.** Class IX includes repair parts and documents required for equipment maintenance operations. Repair parts are issued in response to a specific request or are obtained by direct exchange of repairable parts, to include batteries for night vision devices and man-portable radios. In combat situations, exchange and controlled substitution are the normal means of obtaining Class IX items.

j. **Class X.** Class X includes materials to support nonmilitary programs such as agriculture and economic development. Instructions for request and issue of Class X supplies are provided at division level or higher.

k. **Miscellaneous.** This category covers anything that does not fall in one of the existing classes of supply.











	I	Subsistence items and gratuitous issue health and welfare items: MREs, T-rations, and fresh fruits and vegetables.
	II	Items of equipment, such as clothing TASO, pioneer tools, and NBC overgarments.
	III	Petroleum, oils, and lubricants.
	IV	Construction and barrier materials: lumber, sand bags, and barbed wire.
	V	Ammunition: small arms ammo, artillery, rounds, hand grenades, explosives, mines, fuzes, and detonators.
	VI	Personal demand items: post exchange system items: cigarettes, candy, and soap.
	VII	Major end items: vehicles and major weapons systems.
	VIII	Medical material: medicine, stretchers and surgical instruments.
	IX	Repair parts and components, including kits and assemblies; items for maintenance support: batteries, spark plugs, and axles.
	X	Material to support civil programs such as agriculture and economic development projects: commercial design tractors and farm tools.
MISC		Miscellaneous items that do not fit into one of the classes above: water, maps, captured enemy material, and salvage material.

Figure 11-1. Classes of supply.

11-10. ROUTINE RESUPPLY

Routine resupply operations cover items in Classes I, III, V, and IX, as well as mail and any other items requested by the antiarmor company (or platoon). Whenever possible, routine resupply should be conducted daily, ideally during periods of limited visibility.

a. **Logistics Package Operations.** The LOGPAC technique is a simple, efficient way to accomplish routine resupply operations. Antiarmor company and battalion SOPs specify the exact composition and execution order of the LOGPAC.

(1) **Preparation.** The antiarmor company's supply sergeant first compiles and coordinates all the company's supply requests. Based on the requests, he then assembles the LOGPAC under the supervision of the support platoon leader or the HHC commander. The LOGPAC focuses on the needs of the antiarmor company:

- Replacement personnel and soldiers returning from medical treatment.
- Vehicles returning to the company area from maintenance.
- Mail and personnel action documents (including awards and finance and legal documents) from the battalion S1 section.

When LOGPAC preparations are complete, the supply sergeant initiates tactical movement to the logistic release point (LRP) under the supervision of the battalion support platoon leader. The supply sergeant and LOGPAC linkup with the 1SG at the LRP.

(2) **Actions at the LRP.** When the antiarmor company 1SG arrives at the LRP to pick up the company LOGPAC, he updates all personnel and logistical reports and is briefed by the support platoon leader or other field trains representatives on any changes to the support situation. He then escorts the company's logistics vehicles to the antiarmor company resupply point, providing security during movement from the LRP.

(3) **Resupply Procedures.** The antiarmor company can use the service station (out of position) or tailgate (in position) resupply method, both of which are described later in this section. The time required for resupply is an important planning factor. It must be conducted as quickly and efficiently as possible, both to ensure operational effectiveness and to allow the antiarmor company LOGPAC to return to the LRP on time. Service station resupply of the antiarmor company normally can be completed in approximately 90 minutes, but may take longer. Tailgate resupply usually requires significantly more time than service station resupply.

(4) **Return to the LRP.** Once resupply operations are complete, the LOGPAC vehicles are prepared for the return trip. Antiarmor company vehicles requiring recovery for maintenance or salvage are lined up and prepared for towing. EPWs ride in the cargo trucks and are guarded by walking wounded or other company personnel. All supply requests and personnel action documents are consolidated for forwarding to the field trains, where the appropriate staff section processes them for the next LOGPAC. The 1SG or company supply sergeant leads the company's logistics vehicles back to the LRP, where he links up with the battalion support platoon leader. Whenever possible, the reunited battalion LOGPAC convoy returns to the battalion field trains together. If the company's logistics vehicles arrive too late to rejoin the larger LOGPAC convoy, the vehicles will either move to the battalion combat trains or remain with the company. However, this situation should be avoided.

b. **Resupply Methods.** As directed by the antiarmor company commander or XO, the 1SG establishes the antiarmor company resupply point using either the service station or tailgate method. He briefs each LOGPAC driver on which method to use. When the resupply point is ready, the 1SG informs the company commander who in turn directs each antiarmor platoon or element to conduct resupply based on the tactical situation.

(1) **Service Station Resupply.** When using the service station method, vehicles move individually or in small groups to a centrally located resupply point. Depending on the tactical situation, one antiarmor squad or an entire antiarmor platoon moves out of its position, conducts resupply operations, and then moves back into position. This process continues until the entire unit has been resupplied (Figure 11-2). In using this method,

vehicles enter the resupply point following a one-way traffic flow. Only vehicles requiring immediate maintenance stop at the maintenance holding area. Vehicles move through each supply location, with crews rotating individually to eat, pick up mail and sundries, and refill or exchange water cans. When all platoon vehicles and squads have completed resupply, they move to a holding area where, situation permitting, the antiarmor platoon leader and platoon sergeant conduct a precombat inspection.

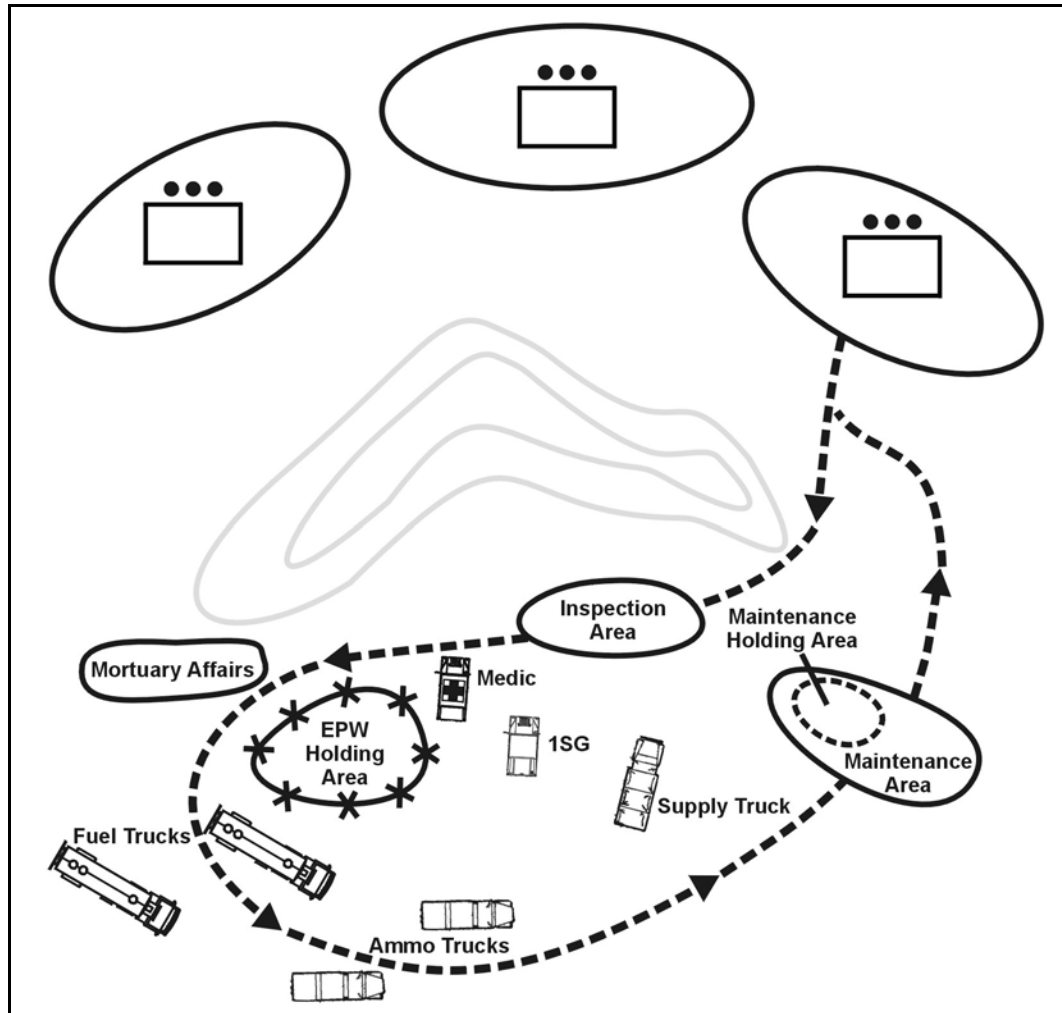

Figure 11-2. Service station resupply method.

(2) **Tailgate Resupply.** The tailgate method (Figure 11-3, page 11-10) is normally used during defensive preparations. Vehicles remain in their positions or back out a short distance to allow trucks carrying supplies to reach them. Buddy-teams rotate through the feeding area, pick up mail and sundries, and fill or exchange water cans. Any EPWs are centralized and guarded.

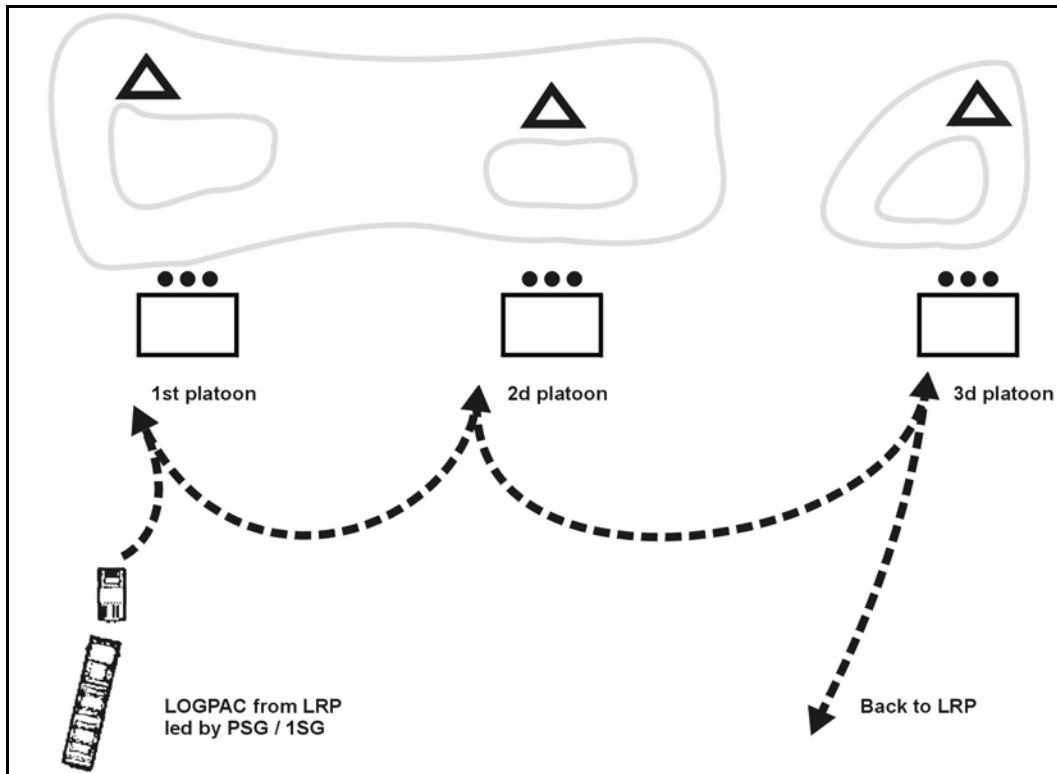

Figure 11-3. Tailgate resupply method.

11-11. EMERGENCY RESUPPLY

Occasionally (normally during combat operations), the antiarmor company (or platoon) may have such an urgent need for resupply that it cannot wait for a routine LOGPAC. Emergency resupply may involve Classes III, V, and VIII, as well as NBC equipment and, on rare occasions, Class I. The battalion normally uses support platoon and medical assets located in the battalion combat trains to conduct emergency resupply of the antiarmor company. Emergency resupply can be conducted using either the service station or tailgate method, although procedures may have to be adjusted when the antiarmor unit is in contact with the enemy. In the service station method, individual vehicles pull back during a lull in combat on order of the antiarmor company commander (or platoon leader); they conduct resupply and then return to the fight. With tailgate resupply, the antiarmor unit brings limited supplies forward to the closest concealed position behind each vehicle or element.

11-12. PRESTOCK OPERATIONS

Prestock resupply, also known as pre-positioning or cache, is most often required in defensive operations. Normally only Class V items are pre-positioned. Class III supplies can be pre-positioned, but this requires company vehicles to refuel before moving into fighting positions during initial occupation of the BP or to move out of their fighting positions to conduct refueling operations at the rear of the BP. Prestock operations must be carefully planned and executed at every level. All leaders, down to antiarmor squad leaders, must know the exact locations of prestock sites, which they verify during reconnaissance or rehearsals. The antiarmor company must take steps to ensure survivability of the prestock supplies. These measures include digging in prestock positions and selecting covered and

concealed positions. The antiarmor company commander must also have a plan to remove or destroy pre-positioned supplies to prevent the enemy from capturing them.

11-13. ANTIARMOR COMPANY RESUPPLY REQUIREMENTS

Company resupply is mainly a "push" system. This means the antiarmor company receives a standard package of supplies from the higher headquarters based on past usage factors and planning estimates. The information-sharing environment provided by FBCB2 (when equipped) reinforces a "push" resupply system.

a. The battalion S4 plans the contents of a LOGPAC. The supplies are normally organized and assembled in the battalion field trains by the antiarmor company supply sergeant under the supervision of the HHC commander and battalion support platoon leader. The LOGPAC should, if possible, provide all supplies, equipment, and personnel needed to sustain the antiarmor company for the next 24 hours or until the next scheduled LOGPAC delivery.

b. Adjustments to the LOGPAC are sent to the battalion S4 (located in the CTCP) via the battalion A/L net, through the antiarmor company supply sergeant, or by a company messenger. When using a battalion A/L net that is not secure, encode reports using the SOI.

c. Company status reports often translate into supply requests, or they provide information to allow the battalion S4 to anticipate antiarmor company needs. An example is the personnel daily summary, which is sent to the battalion S1. It provides the number of personnel in the field, which the battalion S4 can use to plan Class I resupply.

d. The antiarmor supply sergeant is responsible for obtaining supplies and delivering them to the company. He handles small items himself and employs the assets of the support platoon to deliver bulky or high-expenditure items. The antiarmor company commander establishes priorities for delivery, but the demands of combat normally dictate that supplies and equipment in Classes I, III, V, and IX are the most critical to successful antiarmor operations.

Section IV. MAINTENANCE OPERATIONS

The maintenance of weapons and equipment is continuous. Every soldier must know how to maintain his personal weapon and equipment, the antiarmor weapons systems (TOW, M2, and MK19), and the vehicles (HMMWV or ICV). The company commander, XO, 1SG, PSGs, and antiarmor squad leaders must understand maintenance for every piece of equipment in the antiarmor company.

11-14. REQUIREMENTS

Proper maintenance is the key to keeping vehicles, equipment, and other materials in serviceable condition. Maintenance is continuous. It starts with preventive maintenance by the operators and squads, and continues through repairs by maintenance personnel. It includes the services involved in inspecting, testing, servicing, repairing, requisitioning, recovering, and evacuating vehicles and equipment. Personnel should be trained to accomplish necessary maintenance tasks under any condition. Preventive maintenance checks and services (PMCS) on vehicles, weapons, and other equipment should be completed to the standards set in technical manuals and the antiarmor unit's SOP. Maintenance personnel perform repairs as far forward as possible.

a. Antiarmor units in light, airborne, and air assault battalions do not have a

maintenance section that operates in their area. These units depend on an austere maintenance section located in the CTCP. The battalion SOP may employ mobile maintenance teams that respond forward to fix damaged vehicles.

b. When maintenance support is needed to repair a vehicle, it is accomplished in the unit's position. If the repairs cannot be completed within a few hours, the vehicle is normally evacuated to the CTCP. The battalion commander makes this decision, and it may mean the vehicle cannot participate in combat operations. This is especially true in the defense, where the loss of an antiarmor weapon system is a major reduction in combat power for the battalion.

c. The unit SOP should detail when maintenance is performed (at least once a day in the field), to what standards, and who inspects it. The antiarmor squad leader is most often the one who inspects maintenance work, with the platoon sergeant, platoon leader, 1SG, XO, as well as the company commander, conducting spot-checks. One technique is for each to spot-check a different antiarmor squad; another is for each to check a single type of weapon or piece of equipment in all antiarmor squads daily. These instructions must be integrated into the unit's SOP for patrol bases, assembly areas, defenses, and reorganization. To ensure maintenance is done without jeopardizing unit security and to make it a habit for the soldiers, clear guidance must be included in the unit SOP.

d. Maintenance applies to all equipment. In addition to operator maintenance, selected soldiers are trained to perform limited maintenance on damaged weapons and to direct exchange (DX) parts from destroyed weapons.

e. Inoperative equipment is fixed as far forward as possible. When a piece of equipment is damaged, it is inspected to see if it can be repaired on location. The company armorer keeps a small-arms repair kit. The battalion communications section has a limited capability to repair FM radios. If equipment cannot be fixed forward, it is evacuated immediately (in an assembly area or defense area), or turned in using the backhaul method when other supplies are brought forward. Even if the item cannot be evacuated at once, the CSS system is alerted to generate a request for a replacement. If a replacement is available (from an evacuated soldier or scavenged equipment), it is sent forward. If not, the leader must work around it by prioritizing the use of remaining equipment.

11-15. COMPANY ROLE IN MAINTENANCE OPERATIONS

Company maintenance functions begin with PMCS, a daily antiarmor squad responsibility, and crew-level preparation of the prescribed maintenance forms (DA Form 2404, 5988-E, or both, as applicable). These forms are the primary means through which the squad obtains repair parts. They follow a pathway, described in the following paragraphs, from crew level to the battalion field trains and back. The antiarmor company 1SG or XO supervises the "flow" of these critical maintenance documents and of repair parts.

a. Antiarmor squad leaders collect their squad's maintenance forms each day. They give the forms to the platoon sergeant, who consolidates them for the platoon. The platoon sergeant, in turn, gives the forms to the company 1SG or XO, who reviews and verifies problems and deficiencies and requisitions Class IX items needed for maintenance and repairs. During the next LOGPAC operation, the completed forms are given to the company supply sergeant at the LRP, who transfers them to maintenance personnel in the battalion field trains.

b. In the battalion field trains, PLL clerks issue the required repair parts they have on

hand. They order any other required parts and assign a document number and status for the ordered parts. The maintenance forms, amended with the document numbers and status of ordered parts, are returned to the company supply section (along with the issued repair parts). The amended forms and repair parts are transported via the next LOGPAC to the antiarmor company. The antiarmor squad replaces the defective part.

c. The antiarmor squad conducts initial maintenance, repair, and recovery actions on site. Once it is determined that the squad cannot repair or recover the vehicle or equipment, the platoon sergeant contacts the 1SG. If additional assistance is needed, the 1SG requests it from the battalion.

11-16. DESTRUCTION

When a vehicle or piece of equipment cannot be recovered or is damaged beyond repair, the antiarmor unit leader reports the situation to his higher commander. This commander gives permission for destruction of the materiel if that is the only way to prevent capture of the equipment by the enemy. The antiarmor squad removes all radios, weapon systems, ammunition, personal items, and other serviceable items and parts; it also removes all classified materials or paperwork that could be of intelligence value to the enemy. The antiarmor unit then destroys the vehicle or equipment following unit SOP.

Section V. HEALTH SERVICE SUPPORT

Effective, timely medical care is an essential factor in sustaining the antiarmor company's combat power during continuous operations. The antiarmor company commander must ensure that the company's leaders and its medical personnel know how to keep soldiers healthy, how to save their lives if they are wounded or injured, and how to make them well once injury or illness occurs.

11-17. HEALTH AND HYGIENE

The antiarmor company commander and all leaders, in conjunction with the company senior medic and field sanitation team, must emphasize and enforce high standards of health and hygiene at all times. This "preventive maintenance" approach should cover all aspects of the soldier's health and well being, including the following:

- Daily shaving to ensure proper fit of the protective mask.
- Regular changing of clothing directly next to the skin.
- Prevention of weather-related problems. These include cold-weather injuries such as frostbite, trench foot, and immersion foot, and heat-related injuries like heat exhaustion and heat stroke. Soldiers must understand the effects of conditions such as sunburn and wind-chill.
- Effective field sanitation measures, including unit waste control, waste disposal activities and facilities, water purification, rodent control, food service sanitation, and use of insect repellents.
- Battle fatigue prevention, including strict implementation of the unit rest plan.

11-18. SOLDIERS WOUNDED IN ACTION

Medical treatment of wounded or injured soldiers during combat operations is a continuous, progressive operation that occurs in a series of separate but interlocking stages. It involves personnel, equipment, and facilities at virtually every level of the organization. The normal

flow of medical treatment for combat casualties is from the combat lifesaver to the company senior medic at the casualty collection point (CCP) to medics at the BAS. In addition, company leaders play an important role in obtaining and providing medical services for their wounded in action (WIA). The following paragraphs discuss the individual responsibilities of company personnel in this process.

a. **Combat Lifesaver.** The combat lifesaver is almost always the first person on the scene to begin the process of treating wounded and injured personnel. With the help of buddy aid and of the company aidmen, the combat lifesaver provides initial first aid to WIAs. He prepares them for medical evacuation or returns them to duty status after rendering first aid. Whenever possible, the antiarmor company commander should ensure that there is at least one combat lifesaver assigned to each vehicle.

b. **Antiarmor Squad Leader.** The squad leader is responsible for ensuring that wounded or injured antiarmor squad members receive immediate first aid and that the company commander is informed of casualties. He coordinates with the platoon sergeant or company senior medic for evacuation (ground or aerial). The squad leader ensures that casualty feeder reports and witness statement forms are completed and routed to the proper channels. (The casualty feeder report stays with the wounded soldier through the CASEVAC process; witness statements are maintained by the 1SG.)

c. **Senior Medic.** The senior medic is both the company's primary medical treatment practitioner and the supervisor of all battlefield medical operations. The latter role encompasses numerous responsibilities. The senior medic works closely with the antiarmor company commander to ensure all members of the company understand what to do to provide and obtain medical treatment in combat situations. He oversees the training of combat lifesavers and, once combat begins, directs their actions. He assists the antiarmor squad leaders and the 1SG in arranging WIA evacuation. The senior medic is also responsible for monitoring the vital paperwork that is part of the medical treatment and evacuation process:

(1) He ensures that DA Form 1156 (casualty feeder report) remains with each WIA until the soldier reaches a source of definitive medical care (a surgeon or physician's assistant) in the battalion main aid station or field aid station.

(2) If a soldier's remains cannot be recovered, the senior medic ensures that the crew completes DA Form 1155 (witness statement) as quickly as possible and ensures that the form is given to the 1SG for processing.

NOTE: DA Form 1156 is collected at the aid station by designated medical personnel or members of the battalion S1 section; it is sent to the S1 section for further processing through administrative channels in the battalion field trains.

d. **First Sergeant.** The antiarmor company 1SG supervises and coordinates CASEVAC operations, collects witness statements and submits them to the battalion S1, and submits the battle loss report to the battalion main command post, as required. Perhaps his most important duty is managing the company's personnel status during combat operations. As necessary, he directs cross-leveling among platoons and vehicle crews to alleviate personnel shortages. The 1SG also supervises the completion and processing of DA Forms 1155 and 1156.

e. **Company Commander.** The antiarmor company commander has overall

responsibility for medical services. His primary task is to prepare the medical team to treat and evacuate casualties properly. In this role, he works closely with others in the company medical process to ensure that they fully understand the responsibilities described in the previous paragraphs and are proficient in required medical skills. He designates the location for the company's CCP based on a detailed analysis of the factors of METT-TC, and he ensures that all antiarmor squad leaders record the location on appropriate overlays. He also develops and implements appropriate SOPs for CASEVAC. An example is standardized vehicle markings based on the severity of casualties carried on particular vehicles.

11-19. SOLDIERS KILLED IN ACTION

The company commander designates a location for the collection of those killed in action. All personal effects remain with the body, while equipment and issue items become the responsibility of the antiarmor squad leader or section leader until they can be turned over to the 1SG or company supply sergeant. As a rule, KIA remains should not be transported on the same vehicle as wounded soldiers. The company commander sends a letter of condolence to the soldier's next of kin, normally within 48 hours of the death.

11-20. CASUALTY EVACUATION

Effective CASEVAC provides a major increase in the morale of a unit. Casualties are treated where they fall (or under nearby cover and concealment) by a medic, combat lifesaver, or fellow soldier.

a. During the fight, casualties often are left where they received initial treatment (self-aid or buddy-aid). As soon as the situation allows, casualties are moved to the platoon CCP. They then can be evacuated directly to the BAS or to the antiarmor company CCP, which is designated by the antiarmor company commander in the OPORD. The unit SOP should address this activity, to include the marking of casualties during limited visibility operations. Small, standard, or infrared chemical lights work well for this purpose. Once the casualties have been collected, evaluated, and triaged, further evacuation to the battalion CCP or BAS begins. Normally, the BAS is collocated with the battalion CCP.

b. An effective technique, particularly during an attack, is to organize soldiers under the 1SG as a CASEVAC element. These soldiers evacuate casualties to either the company or the battalion CCP, allowing the platoons to continue their fight. The company commander determines the size of the element during his commander's estimate.

c. When the antiarmor company is widely dispersed, the casualties may be evacuated directly from the platoon CCP by vehicle or helicopter. Often, aerial evacuation is restricted by enemy air defense artillery threat. In some cases, the casualties must be moved to the company CCP or battalion CCP before aerial evacuation. When the battalion's organic ambulances are not enough to move the wounded, unit leaders may direct supply vehicles to backhaul casualties to the BAS after supplies are delivered. In other cases, the platoon sergeant may direct platoon litter teams to carry the casualties to the rear.

d. Leaders must minimize the number of soldiers required to evacuate casualties. Casualties with minor wounds can walk or even assist with carrying the more seriously wounded. Soldiers can make field-expedient litters by cutting small trees and putting the poles through the sleeves of buttoned BDU blouses. A travois, or skid, may be used for casualty evacuation. This is a type of litter on which wounded can be strapped, and it can be pulled by one person. A travois can be locally fabricated from durable, rollable plastic on

which tie-down straps are fastened. In rough terrain (or on patrols), casualties may be evacuated to the BAS by litter teams, carried with the unit until transportation can reach them, or left at a position and picked up later.

e. Unit SOPs and OPORDs must address casualty evacuation in detail. They should cover the duties and responsibilities of key personnel, the evacuation of chemically contaminated casualties (on separate routes from noncontaminated casualties), and the priority for manning key weapons and positions. They should specify preferred and alternate methods of evacuation and make provisions for retrieving and safeguarding the weapons, ammunition, and equipment of casualties. Slightly wounded personnel are treated and returned to duty by the lowest echelon possible. Platoon aidmen evaluate sick soldiers and either treat or evacuate them as necessary. Remains are kept covered, separated from the wounded, and are evacuated by backhaul on supply vehicles as soon as possible. Casualty evacuation should be rehearsed like any other critical part of an operation.

f. A casualty report, DA Form 1156 (Figure 11-4), is filled out (usually by the squad leader) when a casualty occurs or as soon as the tactical situation permits. The form is turned in to the platoon sergeant who passes it along to the 1SG. A brief description of how the casualty occurred (to include the place, time, and activity being performed) and who or what inflicted the wound is included. If the squad leader does not have personal knowledge of how the casualty occurred, he gets this information from any soldier who does know. Pocketsize witness statements, DA Form 1155 (Figure 11-5, page 11-18), are used to report missing or captured soldiers or when remains are not recovered. The soldier with the most knowledge of the incident completes the form. This information is used to inform the soldier's next of kin and to provide a statistical base for analysis of friendly or enemy tactics. The antiarmor company commander writes a letter to the soldier's next of kin.

NOTE: Before casualties are evacuated to the company CCP or beyond, leaders should remove all key operational items and equipment, including SOIs, maps, position location devices, and laser pointers. Every antiarmor company unit should establish an SOP for handling the weapons and ammunition of its WIAs.

g. At the company CCP, the senior medic conducts triage of all casualties, takes the necessary steps to stabilize their condition, and initiates the process of moving them to the rear for further treatment. He assists the 1SG in arranging either ground transport or aerial evacuation.

h. When aerial evacuation is not absolutely necessary or when these assets are not available, the company has these options for transporting casualties:

- The senior medic can transport them to the BAS himself. He turns the WIAs over to the battalion medical team, obtains any needed medical supplies, and returns to the antiarmor company location.
- The battalion medical platoon's ambulance section can transport casualties. Although ambulances are battalion assets, they can be task-organized as needed. In some cases, they can be associated with the company.

In either option, battalion medical elements assume responsibility for moving WIAs to the BSA for further treatment and evaluation. There, the forward support battalion (FSB) medical company holds them for up to 72 hours. The wounded soldiers are then returned to duty or sent to the rear for additional care.

UNIT CASUALTY FEEDER REPORT		CONTROL NO. 1	TYPE OF CASUALTY <input checked="" type="checkbox"/> Battle <input checked="" type="checkbox"/> Individual <input type="checkbox"/> Nonbattle <input type="checkbox"/> Multiple	
REPORTING UNIT C BATTERY 5/21ST FA			INFLECTING FORCE <input checked="" type="checkbox"/> Enemy <input type="checkbox"/> Allied <input type="checkbox"/> US <input type="checkbox"/> Other	
DATE / TIME OF INCIDENT 12 NOV 82		LOCATION OF INCIDENT AD/22544.PULDA. FBG		
INDIVIDUAL DATA <input type="checkbox"/> SEE ATTACHED ROSTER OF _____ NAMES				
NAME FOE, ROBERT				
SSN 000-00-0000		RANK SPC	UNIT C BATTERY 5/21ST FA	
Killed in Action / Injured		<input checked="" type="checkbox"/>	Missing in Action / Injured	
Wounded in Action / Injured			Captured	
Duty Status PDY	Rec'd Religious Ministration <input type="checkbox"/> YES <input checked="" type="checkbox"/> NO	Remains Recovered <input type="checkbox"/> YES <input checked="" type="checkbox"/> NO	Remains Identified <input type="checkbox"/> YES <input checked="" type="checkbox"/> NO	
Evacuated <input checked="" type="checkbox"/> NO <input type="checkbox"/> YES, to _____				
DA FORM 1184				
UNIT ACTIVITY AT TIME OF INCIDENT NIGHT TIME DEFENSIVE POSITION.				
INDIVIDUAL CIRCUMSTANCES SP4 FOE WAS THE RADIO OPERATOR FOR SGT. JONES, WHO WAS ATTACHED TO OUR UNIT FOR A MISSION. THEY LEFT THE PERIMETER AT 2000 ON 12NOV 82 TO CONDUCT A PATROL. NEITHER ONE RETURNED THEY DONT ANSWER THE RADIO. FIRING WAS HEARD FORWARD OF OUR POSITION AT 2200 HOURS.				
Line of Duty (Nonbattle only) <input type="checkbox"/> YES <input type="checkbox"/> NO <input type="checkbox"/> UNDETM		LOD Authentication (Cdr or Med Pers only)		
VEHICLE INVOLVED (Nonbattle only) <input type="checkbox"/> YES <input type="checkbox"/> NO				
TYPE	OWNERSHIP	POSITION ABOARD VEHICLE		
AUTHENTICATION				
NAME SMITH, JACK C	RANK 1SG	SSN 000-00-0000	UNIT C BATTERY 5/21ST FA	
DATE 13 NOV 82	SIGNATURE OF INDIVIDUAL PREPARING REPORT Jack C. Smith			

Figure 11-4. Casualty report.

WITNESS STATEMENT ON CASUALTY INCIDENT (AR 800-10)		CHECK APPLICABLE BOX <input type="checkbox"/> Killed in Action/Dead (remains not recovered) <input type="checkbox"/> Wounded in Action/Injured <input checked="" type="checkbox"/> Missing in Action/Missing <input type="checkbox"/> Captured		
1. LAST NAME, FIRST NAME MI (of casualty) <i>FOE, ROBERT</i>		2. SSN	3. RANK <i>SPC</i>	4. SEX <i>M</i>
5. ORGANIZATION <i>C BATTERY 3/2/5T FA</i>		6. DATE OF DEATH OR WHEN LAST SEEN <i>2030, 12 NOV 82</i>		
7. GEOGRAPHICAL LOCATION OF INCIDENT (Include grid coordinates and nearby town) <i>AB 122 344 FULDA, FBG</i>		9. OTHER PERSONS WHO MAY HAVE WITNESSED THIS INCIDENT OR HAVE FURTHER INFORMATION <i>1SG SMITH C BATTERY FA</i>		
9. CIRCUMSTANCES SURROUNDING INCIDENT (if known, include cause of death or condition when last seen, or how identified) <i>SP4 FOE WAS THE RADIO OPERATOR FOR 2LT JONES WHO WAS ATTACHED TO OUR PLATOON FOR A MISSION.</i>				
DA FORM 1156 REPLACES EDITION OF 1 JUN 66, WHICH WILL BE ISSUED AND USED UNTIL EXHAUSTED.				
9. CIRCUMSTANCES SURROUNDING INCIDENT (Continued)				
<i>HE WENT ON PATROL WITH SGT JONES ON 12 NOV 82. HE LEFT OUR LINES AT 2030. NEITHER ONE RETURNED. THEY DONT ANSWER THE RADIO. FBG WAS HEARD FORWARD OF OUR POSITION ABOUT 2200 HOURS.</i>				
10. NAME OF PERSON MAKING STATEMENT <i>R.T. WILLIAMS</i>		11. RANK <i>PSG</i>	12. SSN <i>000-00-000</i>	
13. UNIT <i>C BATTERY 3/2/5T FA</i>	14. DATE <i>13NOV82</i>	15. SIGNATURE <i>R.T. Williams</i>		

Figure 11-5. Witness statement.

Section VI. REORGANIZATION AND WEAPONS REPLACEMENT

To maintain effective, consistent combat power, the antiarmor company must have specific plans and procedures that allow each element to quickly integrate replacement personnel and equipment. Unit SOP should define how soldiers and equipment are prepared for combat, including areas such as uploading, load plans, PCCs, PCIs, and in-briefings.

11-21. REPLACEMENT AND CROSS-LEVELING OF PERSONNEL

Replacements for WIA, KIA, or missing in action (MIA) are requested through the battalion S1. Returning or replacement personnel arriving with the LOGPAC should already have been issued all CTA-50 equipment, MOPP gear, and other items, including their personal weapons. Within the antiarmor company, each platoon leader cross-levels personnel among his squads, with the 1SG controlling cross leveling from platoon to platoon. Soldiers from disabled or destroyed vehicles are used to fill out squads until replacement personnel and vehicles arrive at the company CP.

11-22. PERSONNEL REPLACEMENT PROCEDURES

Integrating replacements into an antiarmor company is important. A new arrival on the battlefield may be scared and disoriented as well as unfamiliar with local SOPs and the theater of operations. The following procedures help integrate new arrivals into an antiarmor company:

- a. The antiarmor company commander meets all new arrivals and welcomes them to the unit. This is normally a brief interview. The company commander should have an SOP for reception and integration of newly assigned soldiers.
- b. The platoon leader and platoon sergeant welcome them to the unit, inform them of unit standards, and introduce them to their antiarmor squad leader.
- c. The antiarmor squad leader introduces the new arrivals to the other members of the antiarmor squad and briefs them on their duty positions. He also ensures that each replacement has a serviceable, zeroed personal weapon as well as ammunition, MOPP gear, and other essential equipment. The in-briefing should cover the antiarmor squad and antiarmor platoon's recent and planned activities.
- d. The new arrival is told about important SOPs and special information on the assigned vehicle and its weapon systems as well as information concerning the platoon and squad's area of operations. He may be given a form letter to send to his next of kin. The letter should tell them where to mail letters and packages and how to use the Red Cross in emergencies.

11-23. REPLACEMENT AND SALVAGING OF EQUIPMENT

Lost, damaged, or destroyed equipment is replaced through normal supply channels and brought forward with the LOGPAC. When vehicles are evacuated to the rear for extended periods, crews remove any serviceable equipment or parts for use on other company vehicles.

11-24. WEAPONS SYSTEM REPLACEMENT OPERATIONS

Weapons system replacement operations (WSRO) are conducted to provide units with fully operational, ready-to-fight replacement weapons systems. They cover both vehicle and crew-served systems. The division provides replacement weapons systems to battalions based on brigade priorities. Before these weapons systems are brought forward for delivery to the antiarmor company, the higher headquarters supervises the completion of all necessary PCCs.

Section VII. COMBAT SERVICE SUPPORT IN THE SBCT

The CSS functions within the SBCT are consolidated under the control of the brigade support battalion (BSB). The BSB commander is the SBCT commander's single CSS operator. His staff manages sustaining operations through an array of digital information and automation systems.

11-25. SBCT SUPPORT METHODS

The BSB is designed to perform distribution-based, centralized CSS functions in accordance with Army XXI CSS concepts. The BSB and other CSS elements within the SBCT use a number of support methods to implement these functions. One of those methods is the establishment and maintenance of the logistics preparation of the

battlefield. This preparation is the process of gathering data against pertinent battlefield components, analyzing their impact on sustaining operations, and integrating them into tactical planning so that they are synchronized with the decisive and shaping operations. Using this process, the BSB commander must choose from among a number of alternatives to recommend those that best support the SBCT commander's priorities and missions. There are a host of decisions, but two key, interrelated decisions on distribution must be made.

- How is support going to be moved to the sub-elements of the SBCT as a whole?
- If delivered to company level, how will support be delivered to platoons, squads, and vehicles?

The tactical situation will dictate which distribution technique the BSB will use. Each technique offers advantages and disadvantages, and no method is the best alternative in all situations.

a. Supplies are configured in unit sets (battalion/company/platoon depending on the level of distribution) and delivered to one or more central locations. Heavy expanded-mobility tactical truck (HEMTT) fuel tankers remain at the site to refuel unit vehicles as they cycle through the supply point. This technique makes maximum use of the capacity of SBCT truck assets by minimizing delivery and turnaround time.

b. Supply point distribution requires unit representatives to move to a supply point to pick up their supplies. Supply point distribution is most commonly executed by means of an LRP. The LRP may be any place on the ground where unit vehicles return to pick up supplies and then take them forward to their unit. Occasionally, the LRP may be in the BSA.

c. The refuel and or resupply on the move (RROM) method of sustainment operations is conducted in much the same way as the refuel on the move (ROM) concept. The supported unit XO or ISG coordinates with the SBCT S4 and BSB support operations section to establish the time and place to conduct the RROM operations IAW the current situation. As a general rule, an RROM operation is established and conducted as part of a unit movement. An RROM point is typically built to support several types of units passing through the point sequentially and provides for most classes of supply, including Class V and water.

d. Immediate resupply, also referred to as "emergency resupply," is the least preferred method of distribution of supplies. Emergency resupply is an indicator of a breakdown in coordination between the supporting unit and the company. If immediate resupply is necessary, all possible means, including options not covered above, may be used to achieve the necessary supply distribution. It is imperative that constant and thorough planning and collaboration occur between the antiarmor company's XO or supply sergeant and the SBCT S4 and the BSB support operations officer (SPO) to minimize, if not eliminate, the need for immediate resupply. Emergency resupply that extends beyond BSB capabilities requires immediate intervention of the Army forces (ARFOR). In this case, the SBCT S4 and BSB SPO immediately coordinate with the next higher echelon of support for the SBCT.

11-26. FIXING THE FORCE

The BSB provides small combat repair teams (CRTs) from the brigade support company (BSC) to support the infantry battalions, the RSTA squadron, and separate companies.

These teams are the first echelon of maintenance for the units. They provide maintenance at the site of breakdown using a limited number of combat spares and battle damage assessment and repair (BDAR) kits. Their objective is to return the combat platform to a mission-capable status quickly using accurate (preferably embedded) diagnostics and limited tools. If they are unable to repair a system, the maneuver unit is responsible for like-vehicle recovery back to the BSA.

a. Once in the BSA, the maintenance control section assesses the vehicle to determine whether it can be returned to a full mission-capable status. If it cannot, the vehicle is placed in a controlled substitution point and stripped of parts to bring other combat platforms to a full mission-capable status. Given the austere organic maintenance capabilities, maintenance of combat unit readiness depends on the use of Class VII.

b. The SBCT has limited ability to perform automotive, armament, missile, communication, power generation, and line replaceable unit repairs. This capability is directly limited by the availability of maintainers and Class IX repair parts. These repairs are achieved by the use of combat spares and controlled substitution in an effort to return the greatest number of systems to a full mission-capable status. Maintenance operates essentially the same way in both the offense and the defense, with the majority of maintenance conducted in the BSA. Units are required to use self-recovery and like-vehicle recovery to the maximum extent possible because of the limited number of wreckers.

11-27. ARMING THE FORCE

The ammunition transfer point (ATP) is located in the BSA or in the vicinity of an airfield. The ATP acts mainly as a temporary distribution point to facilitate rapid Class V resupply to the SBCT. Ammunition is transported to the ATP in mission-configured loads. The ammunition section has limited organic capability to reconfigure loads in the ATP. Units arrive at the ATP to pick up ammunition that is transloaded either into combat platforms or transportation assets. The ATP can also perform rigging for aerial delivery operations if the SBCT has aviation augmentation. The ATP is replenished as required.

11-28. MOVING THE FORCE

The headquarters and distribution company transportation platoon provides transportation support to the SBCT. This support is characterized by a limited, centralized lift capability. The transportation platoon has a 24-hour capability to provide transportation support to the SBCT.

11-29. SUSTAINING THE FORCE

Sustaining the force is the provision of personnel, logistics, combat health support, and other support required to maintain operations or combat until successful accomplishment of the mission. The SBCT operates with extremely austere CSS capability. The primary means of providing supplies to SBCT units is to push pre-configured logistics packages down to company level.

a. **Class I.** Class I items include subsistence items.

(1) **Food.** Food supply will consist of MREs only until food service augmentation arrives. MREs are maintained at the BSB and delivered to the company LRPs. Units send

vehicles from their operating locations to the supply point to pick up quantities of MREs as needed. Supplements to MREs (fresh fruits, beverages, milk, and so forth) may be provided as available through regional contract sources or air.

(2) **Water.** The SBCT antiarmor company deploys with three days of supply (DOS) of water. To ensure potability, preventive medicine personnel must inspect water and water sources. The BSB can store 12,000 gallons and distribute 26,000 gallons of water per day. HEMTT-load handling system (HEMTT-LHS) vehicles pulling palletized load system (PLS) trailers distribute water from 500-gallon blivets mounted on the trucks and trailers.

b. **Classes II, III (P), and IV.** Class II consists of clothing, tools, and individual equipment; limited stocks of Class II items may include preventive medicine and field hygiene items, weapons-cleaning equipment, and special tools. Class III (P) consists of packaged petroleum products; limited Class III (P) includes enough packaged petroleum products to maintain daily operations of vehicles and equipment and to support organizational maintenance. Class IV consists of barrier and construction materials. The BSB maintains a very limited stock of Class IV items, focusing on barrier material and survivability items such as concertina wire, sandbags, and pickets.

c. **Class VI.** Class VI supplies (personal hygiene, comfort, and welfare items) includes such things as candy, gum, dental care products, soap, and stationery. Initially, the soldier carries these personal items with him. The BSB does not deploy with Class VI to support the SBCT. Class VI items are requisitioned and delivered based on unit demand.

d. **Class VII.** Class VII supplies (major end-items such as vehicles) are intensively managed and are normally command-controlled. Class VII replacement is based on losses reported through command channels to the SBCT operations officer and logistics officer using an automated reporting system. This permits the commander to maintain awareness of the operational status of subordinate commands and to direct the distribution of items to those units having the most critical need.

e. **Class VIII.** During deployment, lodgment, and early buildup phases, medical units operate from planned, prescribed loads and from pre-positioned war reserve materiel identified in applicable contingency plans. The SBCT's medical assets deploy with 3 DOS to support a 72-hour self-sustainment mission.

f. **Class IX.** Class IX (repair parts) includes major assemblies such as engines and transmissions, as well as wheels, tires, batteries, and circuit cards. All repair parts are located in the BSB. The BSB deploys with a limited amount of repair parts (very constrained authorized stockage list), with priority of those parts normally going to command and control systems, combat systems, and then support systems.

11-30. MANNING THE FORCE

The SBCT S1 and augmenting echelon above division (EAD) personnel service support (PSS) units perform all manning functions for the SBCT.

11-31. RESPONSIBILITY OF COMPANY PERSONNEL

The responsibilities of the company personnel are similar to those of the infantry or antiarmor companies in the light, airborne, and air assault battalions. The role the supply sergeant plays in CSS in the SBCT antiarmor company is the significant difference. In

addition to his traditional responsibilities of being the company's representative in the BSA, the supply sergeant coordinates directly with the SBCT rear CP or the BSB main CP.

(a) **First Sergeant.** The 1SG's role as the company CSS executor has changed. He is more a CSS planner and overseer, with his primary responsibility being the senior tactical advisor to the commander on the employment of antiarmor assets. He ensures that the supply sergeant understands the current tactical situation in order to adjust CSS as necessary.

(b) **Supply Sergeant.** The supply sergeant assists in the assembly of the LOGPAC and moves it forward to the company resupply point. He assists the 1SG with resupply and coordinates the company's CSS requirements with the SBCT S4 or the BSB SPO. The supply sergeant can control the CRT when it is unable to remain forward with the antiarmor company. He monitors the tactical situation and adjusts the company's CSS plan as appropriate to meet the tactical plan and the company commander's intent. He forecasts the company's consumption of the classes of supply based on the operation.

APPENDIX A
WEAPON REFERENCE DATA

A leader must understand the capabilities of his available weapons systems to employ them appropriately. This appendix describes the characteristics of the TOW, MK19 (40-mm), and M2 (caliber .50 MG).

A-1. TOW CHARACTERISTICS

The basic TOW missile, the BGM-71A, has a maximum range of 3,000 meters. All other models have a maximum range of 3,750 meters. All TOW missiles have a minimum arming range of 65 meters except the TOW 2B, which has a minimum arming range of 200 meters.

a. **Types.** Table A-1, page A-2, lists TOW missiles by type and plate data. Other characteristics are as follows--

(1) **BGM-71A.** The basic TOW warhead has a 5-inch, high-explosive, shaped-charge warhead. It is no longer planned for use in combat.

(2) **BGM-71B.** This upgraded warhead can fire at targets as far away as 3,750 meters. It is no longer planned for use in combat.

(3) **BGM-71C.** The improved TOW (ITOW) missile is the first model with the extensible probe. This probe allows the warhead to detonate at greater ranges and to achieve greater penetration than previous models.

(4) **BGM-71D.** The TOW 2 has a 6-inch full-caliber warhead with an extensible probe that can penetrate appliqué armor. The round also has a thermal beacon that enables it to overcome enemy electronic countermeasures (ECM) when fired from a TOW 2 launcher.

(5) **BGM-71E.** The TOW 2A warhead has an explosive charge in the tip of its extensible probe that detonates reactive armor. This enables the main warhead to penetrate the target.

(6) **BGM-71F.** The TOW 2B is a top attack (fly-over, shoot-down) missile. This missile can penetrate the most vulnerable part of an armored vehicle--the top deck of the turret and hull.

b. **Missile Selection.** Based on a thorough analysis of the factors of METT-TC, the leader determines specific missiles for different conditions. Missile-to-target selection preferences (by priority) are listed in Table A-2, page A-2. Flank shots increase the probability of a single-shot kill and reduce the chance of detection or engagement by enemy armor. This applies to any type of target.

c. **TOW Limitations.** FM 3-23.34 (23-34) discusses the following firing limitations in detail:

- Firing over water.
- Firing over electrical lines.
- Firing in windy conditions.
- Firing through smoke and area fires.
- Firing from bunkers and buildings.
- Clearance requirements.

TYPE OF TOW ROUND	HIGH-EXPLOSIVE ROUND		PRACTICE ROUND
	PLATE DATA		
Improved TOW (ITOW)	GUIDED MISSILE, SURFACE ATTACK, ITOW, BGM-71C	Extensible probe improves standoff and penetration	GUIDED MISSILE, PRACTICE, ITOW, BTM-71A-1
TOW 2	GUIDED MISSILE, SURFACE ATTACK, TOW2, BGM-71D	6-inch full-caliber warhead with probe penetrates appliqué armor; thermal beacon improves resistance to enemy ECM when round is fired through TOW2 launcher	GUIDED MISSILE, PRACTICE, TOW2, BTM-71D-1B
TOW 2A	GUIDED MISSILE, SURFACE ATTACK, TOW2A, BGM-71E	6-inch tandem warhead with probe tip charge penetrates reactive and basic armor	GUIDED MISSILE, PRACTICE, TOW2A, BGM-71E
TOW 2B	GUIDED MISSILE, SURFACE ATTACK, TOW2B, BGM-71F	Missile can fly over and shoot down on the vulnerable top of target	GUIDED MISSILE, PRACTICE, TOW2B, BGM-71F

Table A-1. TOW missile types.

TYPE OF TARGETS	TOW MISSILE SELECTION PRIORITY			
	FIRST	SECOND	THIRD	FOURTH
Tanks with appliqué armor	TOW 2	TOW 2A	TOW 2B	ITOW
Tanks with explosive reactive armor	TOW 2B	TOW 2A	TOW 2	ITOW
Tanks without appliqué or reactive armor	ITOW	TOW 2	TOW 2A	TOW 2B
Light-armored personnel carriers	ITOW	TOW 2	TOW 2A	TOW 2B
Light-armored wheeled vehicles	ITOW	TOW 2	TOW 2A	TOW 2B
Antiaircraft vehicles	ITOW	TOW 2	TOW 2A	TOW 2B
Armored vehicles in hull-defilade position	TOW 2B	TOW 2A	TOW 2	ITOW
Bunkers or fortifications	ITOW	TOW 2	TOW 2A	

Table A-2. Missile selection.

A-2. MK19 AND M2 CHARACTERISTICS

The addition of the MK19 and M2 (Table A-3) makes the antiarmor platoon more flexible than previous units equipped with only the TOW system. These weapons allow the platoon to engage personnel and light-armored vehicles with accurate fire past 2,000 meters. These weapons also allow the platoon to secure itself during movement. In restrictive terrain where a TOW may be ineffective, these weapons enable the platoon to engage enemy elements. They also provide the battalion commander with a highly mobile, hard-hitting force in operations where an enemy armor threat is minimal.

CHARACTERISTICS	MK19 (40-mm)	M2 (cal .50)
WEIGHT (TOTAL)	140.6 LBS	128 LBS
WEAPON (WITH BARREL)	75.6 LBS	84 LBS
TRIPOD	44.0 LBS	44 LBS
GUN CRADLE	21.0 LBS	NA
BARREL	NA	24 LBS
MAXIMUM RANGE	2,212 METERS	6,764 METERS
MAXIMUM EFFECTIVE RANGE		
POINT	1,500 METERS	1,500 METERS
AREA	2,212 METERS	1,830 METERS
RATE OF FIRE		
SUSTAINED	40 RPM	40 RPM
RAPID	60 RPM	40 RPM
CYCLIC	325 TO 375 RPM	450 TO 550 RPM

Table A-3. MK19 and M2 characteristics.

a. The MK19 fires HE and high explosive, dual-purpose (HEDP) rounds. The HE round is effective against unarmored vehicles and personnel. The HE round arms 18 to 30 meters after being fired and has a casualty-producing radius of 15 meters. The HEDP round arms at the same range as the HE and penetrates 50.8-mm of rolled homogeneous armor. The round also has a bursting radius of 15 meters. Unlike ammunition for the M2, the ammunition for the MK19 may not be mixed together.

b. The M2 employs standard ball, tracer, armor-piercing, incendiary, and armor-piercing (incendiary) ammunition. The tracer rounds are used to aid in observing fire. The incendiary rounds are used to produce an incendiary effect, especially against aircraft. The armor-piercing rounds are used against armored targets and can penetrate 25-mm of rolled homogeneous armor at 200 meters. The armor-piercing round can also penetrate 14 inches of sand at 200 meters.

c. Some countries equip their light-armored vehicles with appliqué armor, which reduces the effectiveness of the MK19 and M2. Gunners need to engage vehicles at closer range and expend more ammunition to destroy the vehicles. Gunners must continue to engage the vehicles until they see the desired results.

APPENDIX B

RISK MANAGEMENT AND FRATRICIDE AVOIDANCE

The primary objective of risk management and fratricide avoidance is to help units protect their combat power through accident prevention, enabling them to win the battle quickly and decisively with minimum losses. This appendix focuses on two topics: risk management and the avoidance of fratricide. Risk is the chance of injury or death for individuals and of damage to or loss of vehicles and equipment. Risks, or the potential for risks, are always present in every combat and training situation. Risk management must take place at all levels of the chain of command during each step of every operation; it is an integral part of planning. The company commander, platoon leader(s), non-commissioned officers, and all soldiers must know how to use risk management, coupled with fratricide avoidance measures, to ensure the unit executes the mission in the safest possible environment within mission constraints. For additional information on risk management, refer to FM 100-14

Section I. RISK MANAGEMENT

Risk management is the process of identifying and controlling hazards to conserve combat power and resources. Leaders must always remember that the effectiveness of the process depends on the factors of METT-TC. They should never approach risk management with “one size fits all” solutions to the hazards their unit faces. They must consider the essential tactical and operational factors that make each situation unique. There are five steps of risk management. This five-step process is integrated within the troop-leading procedures (Table B-1).

Troop Leading Procedures	Risk Management Steps				
	Step 1 Identify Hazards	Step 2 Assess Hazards	Step 3 Develop Controls and Make Risk Decisions	Step 4 Implement Controls	Step 5 Supervise and Evaluate
Receive the Mission	X				
Issue a Warning Order	X	X			
Make a Tentative Plan	X	X	X		
Initiate Movement	X	X	X	X	X
Conduct Reconnaissance		X	X	X	X
Complete the Plan		X	X		
Issue the Order				X	
Supervise/ Refine	X	X	X	X	X
Execute and Assess ¹	X	X	X	X	X

¹ All boxes are marked to emphasize the continued use of the risk management process throughout the mission.

Table B-1. Risk management and TLP.

B-1. IDENTIFY HAZARDS

A hazard is a source of danger. It is any existing or potential condition that could result in injury, illness, or death of personnel; damage to or loss of equipment and property; or some other form of mission degradation. Hazards arise in both tactical operations and training. Leaders must identify the hazards associated with all aspects and steps of the operation, paying particular attention to the factors of METT-TC. Risk management must never be an afterthought; leaders must begin the process during troop-leading procedures and continue it throughout the operation. Table B-2 lists possible sources of risk the company may face during a typical tactical operation. The list is organized according to the factors of METT-TC.

<p>MISSION</p> <p>Duration of the operation.</p> <p>Complexity or clarity of the plan. (Is the plan well developed and easily understood?)</p> <p>Proximity and number of maneuvering units.</p>
<p>ENEMY</p> <p>Knowledge of the enemy situation.</p> <p>Enemy capabilities.</p> <p>Availability of time and resources to conduct reconnaissance.</p>
<p>TERRAIN AND WEATHER</p> <p>Visibility conditions, including light, dust, fog, and smoke.</p> <p>Precipitation and its effects on mobility.</p> <p>Extreme temperatures.</p> <p>Additional natural hazards (broken ground, steep inclines, and water obstacles).</p>
<p>TROOPS AND SUPPORT AVAILABLE</p> <p>Equipment status.</p> <p>Morale.</p> <p>Experience units conducting the operation have working together.</p> <p>Soldier and leader proficiency.</p> <p>Soldier and leader rest situation.</p> <p>Degree of acclimatization to environment.</p> <p>Impact of new leaders and crewmembers.</p>
<p>TIME AVAILABLE</p> <p>Time available for planning and rehearsals.</p> <p>Time available to conduct the mission.</p>
<p>CIVIL CONSIDERATIONS</p> <p>Applicable ROE and ROI.</p> <p>Potential stability operations and support operations involving contact with civilians (such as refugee, disaster assistance, or counterterrorism).</p> <p>Potential for media contacts or inquiries.</p>

Table B-2. Examples of potential hazards.

B-2. ASSESS HAZARDS TO DETERMINE RISKS

Hazard assessment is the process of determining the direct impact of each hazard on an operation (in the form of hazardous incidents). Use the following steps.

- a. Determine what hazards can be eliminated or avoided.
- b. Assess each hazard that cannot be eliminated or avoided to determine the probability that the hazard will occur.
- c. Assess the severity of hazards that cannot be eliminated or avoided. Severity, defined as the result or outcome of a hazardous incident, is expressed by the degree of injury or illness (including death), loss of or damage to equipment or property, environmental damage, or other mission-impairing factors (such as unfavorable publicity or loss of combat power).
- d. Take into account both the probability and severity of a hazard and determine the associated risk level (extremely high, high, moderate, or low). Table B-3 summarizes the four risk levels.
- e. Based on the factors of hazard assessment (probability, severity, and risk level, as well as the operational factors unique to the situation), complete risk management worksheet. (Refer to Figure B-1, page B-4, for an example of a completed risk management worksheet.)

RISK LEVEL	MISSION EFFECTS
Extremely high (E)	Mission failure if hazardous incidents occur in execution.
High (H)	Significantly degraded mission capabilities in terms of required mission standards. Not accomplishing all parts of the mission or not completing the mission to standard (if hazards occur during mission).
Moderate (M)	Expected degraded mission capabilities in terms of required mission standards. Reduced mission capability (if hazards occur during the mission).
Low (L)	Expected losses have little or no impact on mission success.

Table B-3. Risk levels and impact on mission execution.

A. Mission or Task: Conduct a deliberate attack		B. Date/Time Group Begin: 010035R May XX End: 010600R May XX		C: Date Prepared: 29 April XX	
D. Prepare By: (Rank, Last Name, Duty Position) CPT Smith, Cdr					
E. Task	F. Identify Hazard	G. Assess Hazard	H. Develop Controls	I. Determine Residual Risk	J. Implement Controls (How To)
Conduct obstacle breaching operations	Obstacles	High (H)	Develop and use obstacle reduction plan	Low (L)	Unit TSOP, OPORD, training handbook
	Inexperienced soldiers	High (H)	Additional training and supervision	Moderate (M)	Rehearsals, additional training
	Operating under limited visibility	Moderate (M)	Use NVDs, use IR markers on vehicles	Low (L)	Unit TSOP, OPORD
	Steep Cliffs	High (H)	Rehearse using climbing ropes	Moderate (M)	FM 3-97.6, Mountain Operations; TC 90-6-1, Mountaineering
	Insufficient planning time	High (H)	Plan and prepare concurrently	Moderate (M)	OPORD, Troop-leading procedures
K. Determine overall mission/task risk level after controls are implemented (circle one)					
<p style="text-align: center;"> LOW (L) MODERATE (M) HIGH (H) EXTREMELY HIGH (E) </p>					

Figure B-1. Completed risk management worksheet.

B-3. DEVELOP CONTROLS AND MAKE RISK DECISIONS

Step 3 consists of two substeps: develop controls and make risk decisions. This step is done when making a tentative plan (COA development, COA analysis, COA comparison, and COA approval) during the troop-leading procedures.

a. **Develop Controls.** Controls are the procedures and considerations the unit uses to eliminate hazards or reduce their risk. After assessing each hazard, develop one or more controls that will either eliminate the hazard or reduce the risk (probability, severity, or both) of potential hazardous incidents. When developing controls, consider the reason for the hazard, not just the hazard itself.

b. **Make Risk Decisions.** A key element in the process of making a risk decision is determining whether accepting the risk is justified or, conversely, is unnecessary. The decision-maker must compare and balance the risk against mission expectations, then decide if the controls are sufficient and acceptable and whether to accept the resulting residual risk. If the risk is determined unnecessary, the decision-maker directs the development of additional controls or alternative controls; as another option, he can modify, change, or reject the selected COA for the operation.

B-4. IMPLEMENT CONTROLS

Implementing controls is the most important part of the risk management process. It is the chain of command's contribution to the safety of the unit. Implementing controls includes coordination and communication with appropriate superior, adjacent, and

subordinate units and with individuals executing the mission. The company commander or platoon must ensure that specific controls are integrated into orders, SOPs, and rehearsals. The critical check for this step is to ensure that controls are converted into clear, simple execution orders understood by all levels. If the leaders have conducted a thoughtful risk assessment, the controls will be easy to implement, enforce, and follow. Examples of risk management controls include the following:

- Thoroughly brief all aspects of the mission, including related hazards and controls, and ensure that subordinates know the plan.
- Allow adequate time for rehearsals at all levels.
- Drink plenty of water, eat well, and get as much sleep as possible (at least 4 hours in any 24-hour period).
- Enforce speed limits, use of seat belts, and driver safety.
- Establish control measures or recognizable visual signals and markers to distinguish maneuvering units.
- Enforce the use of ground guides in assembly areas and on dangerous terrain.
- Limit single-vehicle movement.
- Establish SOPs for the integration of new personnel.

B-5. SUPERVISE AND EVALUATE

During mission execution, leaders must ensure their subordinates properly understand and execute risk management controls. Leaders must continuously evaluate the unit's effectiveness in managing risks to gain insight into areas that need improvement.

a. **Supervision.** Leadership and unit discipline are the keys to ensuring implementation of effective risk management controls. All leaders are responsible for supervising mission rehearsals and execution to ensure standards and controls are enforced. In particular, NCOs must enforce established safety policies as well as controls developed for a specific operation or task. Techniques include spot checks, inspections, SITREPs, confirmation briefs, and supervision. During mission execution, leaders must continuously monitor risk management controls to determine whether they are effective and to modify them as necessary. Leaders must also anticipate, identify, and assess new hazards. They ensure that imminent danger issues are addressed on the spot and that ongoing planning and execution reflect changes in hazard conditions.

b. **Evaluation.** Whenever possible, the risk management process should also include an after-action review (AAR) to assess unit performance in identifying risks and preventing hazardous situations. Leaders should then incorporate lessons learned from the process into unit SOPs and plans for future missions.

c. **Commanders Guidance.** The company commander gives the platoon leaders direction, sets priorities, and establishes the command climate (values, attitudes, and beliefs). Successful preservation of combat power requires him to imbed risk management into individual behavior. To fulfill this commitment, leaders must exercise creative leadership, innovative planning, and careful management. Most importantly, the commander must demonstrate support for the risk management process within the troop-leading procedures. The commander and others in the chain of command can establish a command climate favorable to risk management integration by--

- Demonstrating consistent and sustained risk management behavior through leading by example and stressing active participation throughout the risk management process.
- Providing adequate resources for risk management. Every leader is responsible for obtaining the assets necessary to mitigate risk and for providing them to subordinate leaders.
- Understanding their own and their soldier's limitations, as well as their unit's capabilities.
- Allowing subordinates to make mistakes and learn from them.
- Demonstrating full confidence in subordinates' mastery of their trades and their ability to execute a chosen COA.
- Keeping subordinates informed.
- Listening to subordinates.

d. **Leader Responsibility.** For the commander, his subordinate leaders, and individual soldiers alike, responsibilities in managing risk include the following:

- Making informed risk decisions; establishing and then clearly communicating risk decision criteria and guidance.
- Establishing clear, feasible risk management policies and goals.
- Training the risk management process. Ensure subordinates manage risk and understand how risk management applies to their situation and assigned responsibilities..
- Accurately evaluating the unit's effectiveness as well as subordinates' execution of risk controls during the mission.
- Informing higher headquarters when risk levels exceed established limits.

Section II. FRATRICIDE AVOIDANCE

Fratricide avoidance is a complex problem defying simple solutions. Fratricide can be defined broadly as the unforeseen and unintentional death or injury to friendly personnel and damage of or loss of equipment as a result of employing friendly weapons and munitions with the intent of killing the enemy or destroying his equipment or facilities. This section focuses on actions leaders can take to reduce the risk and occurrence of fratricide using current resources.

B-6. MAGNITUDE OF THE PROBLEM

The modern battlefield is more lethal than any battlefield in history. The tempo of operations is rapid, and the nonlinear nature of the battlefield creates command and control challenges for unit leaders. The accuracy and lethality of modern weapons make it possible to engage and destroy enemy targets at extended ranges. However, the ability of US forces to acquire targets using thermal imagery and other sophisticated sighting systems exceeds its capability to accurately identify these targets. Consequently, friendly elements can be engaged unintentionally and destroyed in a matter of seconds. Added to this is battlefield obscurity, which becomes a critical consideration whenever thermal sights are the primary source of target identification. Rain, dust, fog, smoke, and snow degrade identification capability by reducing the intensity and clarity of thermal images. On the battlefield, positive visual identification cannot be the sole engagement criteria at

ranges beyond 1,000 meters. A common operational picture, either digital or analog, is essential and must be maintained throughout any operation.

B-7. RISK IDENTIFICATION AND PREVENTIVE MEASURES

Reduction of fratricide risk begins during the planning phase of an operation and continues through preparation and execution. Risk identification must be conducted at all levels during each phase and the results clearly communicated up and down the chain of command so risk assessment can begin. The following paragraphs cover considerations influencing risk identification and focuses on measures the leader can implement to make the identification process more effective and help prevent friendly fire incidents from occurring.

B-8. PLANNING

A thoroughly developed, clearly communicated, and completely understood plan helps minimize fratricide risk. The following factors affect the potential for fratricide in a given operation:

- Clarity of the enemy situation.
- Clarity of the friendly situation.
- Clarity of the commander's intent and concept of operations.
- Complexity of the operation.
- Planning time available at each level.

Graphics are a basic tool commanders at all levels use to clarify their intent, add precision to their concept, and clearly communicate their plan to subordinates. Graphics can be a very useful tool in reducing the risk of fratricide. Each commander must understand the definitions and purposes of operational graphics and the techniques of their employment. FM 1-02 (101-5-1) defines each type of graphic control measure.

B-9. PREPARATION

Confirmation briefs and rehearsals are primary tools for identifying and reducing fratricide risk during preparation for an operation. The following are considerations for their use:

- a. Confirmation briefs and rehearsals ensure subordinates know where fratricide risks exist and what to do to reduce or eliminate them.
- b. Briefbacks ensure subordinates understand the commander's intent. They often highlight areas of confusion or complexity or planning errors.
- c. The type of rehearsal conducted determines the types of risks identified.
- d. Rehearsals should extend to all levels of command and involve all key players.
- e. The following factors may reveal fratricide risks during rehearsals:
 - Number and type of rehearsals.
 - Training and proficiency levels of units and individuals.
 - The habitual relationships between units conducting the operation.
 - The physical readiness (endurance) of the troops conducting the operation.

B-10. EXECUTION

Risk assessments continuing during execution and improvisation can overcome unforeseen fratricide risk situations.

a. The following are factors to consider when assessing fratricide risks:

- Intervisibility between adjacent units.
- Amount of battlefield obscuration.
- Ability or inability to identify targets positively.
- Similarities and differences in equipment, vehicles, and uniforms between friendly and enemy forces.
- Vehicle density on the battlefield.
- The tempo of the battle.

b. Maintaining a COP of friendly forces at all levels and at all times is another key to fratricide avoidance as an operation progresses. Units develop and employ effective techniques and SOPs to aid leaders and crewmen in this process, to include--

- Monitoring the next higher radio or digital net.
- Radio and digital cross-talk between units.
- Accurate position reporting and navigation.
- Training, use, and exchange of liaison officers.

B-11. FRATRICIDE REDUCTION MEASURES

The following measures provide a guide to actions that can reduce fratricide risk. Use of these measures is not required, nor are they intended to restrict initiative. Apply them as appropriate based on the specific situation and METT-TC factors:

a. Identify and assess potential fratricide risks in the estimate of the situation. Develop a simple, decisive plan and express these risks in an order (WARNO, OPORD or FRAGO).

b. Focus on areas such as current intelligence, unit locations and dispositions, denial areas (minefields and FASCAM), contaminated areas such as improved conventional munitions (ICM) and NBC, SITREPs, and METT-TC factors.

c. Ensure positive target identification. Review vehicle and weapon ID cards. Know at what ranges and under what conditions positive identification of friendly vehicles and weapons is possible.

d. Establish a command climate that stresses fratricide prevention. Enforce fratricide prevention measures and emphasize the use of doctrinally sound techniques and procedures. Ensure constant supervision in the execution of orders and the performance of all tasks and missions.

e. Recognize the signs of battlefield stress. Maintain unit cohesion by taking quick, effective action to alleviate battlefield stress.

f. Conduct individual, leader, and collective (unit) training covering fratricide prevention, target identification and recognition, and fire discipline.

g. Use SOPs that are consistent with doctrine to simplify mission orders. Periodically review and change SOPs as needed.

h. Strive for maximum planning time for your subordinates.

i. Use doctrinally correct standard terminology and control measures, such as fire support coordination line and restrictive fire lines.

j. Ensure thorough coordination is conducted.

- k. Plan for and establish effective communications (to include visual).
- l. Plan for collocation of command posts whenever it is appropriate to the mission, such as during a passage of lines.
- m. Ensure ROE are clear.
- n. Include fratricide risk as a key factor in terrain analysis (OAKOC).
- o. Conduct rehearsals whenever the situation allows time to do so.
- p. Be in the right place at the right time. Use position location and navigation devices (GPS and POSNAV); know your location and the locations of adjacent units (left, right, leading, and follow-on). Synchronize tactical movement.
- q. Plan and brief OPSEC (challenge and password, sign and countersign).
- r. Whenever possible, the risk management process should also include AAR to assess unit performance in identifying risks and preventing hazardous situations. Leaders should then incorporate lessons learned from the process into unit SOPs and plans for future missions.
- s. Stress the importance of the chain of command in the fire control process (see Appendix C); ensure soldiers get in the habit of obtaining target confirmation and permission to fire from their leaders before engaging targets they assume are enemy elements.
- t. Ensure fire commands are accurate, concise, and clearly stated. Make it mandatory for soldiers to ask for clarification of any portion of the fire command that they do not completely understand.

B-12. FRATRICIDE AVOIDANCE CONSIDERATIONS

Table B-4, pages B-10 and B-11, contains key factors and considerations in fratricide avoidance, paralleling the five-paragraph operations order format. This is not a change to the OPORD format but is a technique to ensure fratricide avoidance measures are included when completing the plan during the TLP. The factors and considerations are listed where they would likely appear in the OPORD, but they may warrant evaluation during preparation of other paragraphs.

<p>Task Organization:</p> <ul style="list-style-type: none"> • Has the unit worked under this task organization before? • Are SOPs compatible with the task organization (especially with attached units)? • Are special markings or signals (for example, cats' eyes, chemlites, or panels) needed for positive identification of uniforms and equipment? • What special weapons and equipment are to be used? Do they look or sound like enemy weapons and equipment?
<p>1. Situation.</p> <p>a. Enemy Forces.</p> <p>(1) <i>Weather:</i></p> <ul style="list-style-type: none"> • What are the expected visibility conditions (light data and precipitation) for the operation? • What affects will rain, heat, and cold have on soldiers, weapons, and equipment? <p>(2) <i>Terrain:</i></p> <ul style="list-style-type: none"> • Do you know the topography and vegetation (urban, mountainous, hilly, rolling, flat, desert, swamp/marsh, prairie/steppe, jungle, or open woods) of the expected AO? • Have you evaluated the terrain using the factors of OAKOC? <p>b. Friendly Forces.</p> <ul style="list-style-type: none"> • Among the allied forces, are there differences (or similarities with enemy forces) in language, uniform, and equipment that could increase fratricide risk during combined operations? • Could differences in equipment and uniforms among US armed forces increase fratricide risk during joint operations? • What differences in equipment and uniforms can leaders stress to help prevent fratricide? • What is the friendly deception plan? • What are the locations of your unit and adjacent units (left, right, leading, and follow-on)? • What are the locations of neutrals and noncombatants? • What are the locations of your own forces? • What is the status of training activities? • What are the levels of individual, crew, and unit proficiency? • Will fatigue be a factor for friendly forces during the operation? Has an effective sleep plan been developed? • Are friendly forces acclimatized to the AO? • What is the age (new, old, or mixed) and condition of equipment in friendly units? • What is the status of new equipment training? • What are the expected MOPP requirements for the operation? <p>c. Attachments and Detachments.</p> <ul style="list-style-type: none"> • Do attached elements understand pertinent information regarding enemy and friendly forces? • Will gaining units provide this pertinent information to detached elements? • Are communications systems compatible (digital/analog)?
<p>2. Mission.</p> <ul style="list-style-type: none"> • Do all elements clearly understand the mission and all associated tasks and purposes?

Table B-4. Fratricide avoidance checklist.

<p>3. Execution.</p> <p>a. Concept of the Operation.</p> <p>(1) <i>Maneuver</i>: Are main and supporting efforts identified?</p> <p>(2) <i>Fires (Direct and Indirect)</i>:</p> <ul style="list-style-type: none"> • Are priorities of fires identified? • Have target lists been developed? • Have the fire execution matrix and overlay been developed? • Have locations of denial areas (minefields and FASCAM) and contaminated areas (ICM and NBC) been identified? • Are the locations of all supporting fire targets identified in the order and overlays? • Are aviation and CAS targets clearly identified? • Has the direct fire plan been developed? • Have FPFs been designated? • Are the requirements for accurate predicted fire met or do we have to adjust fire? <p>(3) <i>Engineer Tasks</i>:</p> <ul style="list-style-type: none"> • Are friendly minefields, including FASCAM and ICM dud-contaminated areas, known? • Have obstacles and the approximate time needed for reduction or breaching of each been identified? <p>(4) <i>Tasks to Each Subordinate Unit</i>: Are friendly forces identified, as appropriate, for each subordinate maneuver element?</p> <p>(5) <i>Tasks to CS and CSS Units</i>: Have locations of friendly forces been reported to CS and CSS units?</p> <p>b. Coordinating Instructions.</p> <ul style="list-style-type: none"> • Will rehearsals be conducted? Are they necessary? Are direct and indirect fires included? • Is a confirmation brief necessary? • Are appropriate control measures clearly explained and illustrated in the order and overlays? Have they been disseminated to everyone who has a need to know? What is the plan for using these control measures to synchronize the battle and prevent fratricide? • Have target and vehicle identification drills been practiced? • Do subordinate units know the immediate action, drill, or signal for “CEASE FIRE” and “I AM FRIENDLY” if they come under unknown or friendly fire? Is there a backup? • Is guidance in handling dud munitions, such as ICM and cluster bomb units (CBU), included?
<p>4. Service Support.</p> <ul style="list-style-type: none"> • Does everyone know train locations and identification markings? • Do medical and maintenance personnel know the routes between train units? <p>5. Command and Signal.</p> <p>a. Command.</p> <ul style="list-style-type: none"> • What are the locations of the commander and key staff members? • What are the chain of command and the succession of command? <p>b. Signal.</p> <ul style="list-style-type: none"> • Do instructions include backup code words and visual signals for all special and emergency events? • Do instructions cover how to identify friendly forces to aircraft? • Do they include backup code words and visual signals for all special and emergency events? • Are SOI distributed to all units with a need to know, such as higher, lower, adjacent, leading, and follow-on elements?

Table B-4. Fratricide avoidance checklist (continued).

APPENDIX C
DIRECT FIRE PLANNING AND CONTROL

Suppressing or destroying the enemy with direct fires is fundamental to success in close combat. Effective direct fires are the unique contribution of maneuver forces to the combined arms team. Because fire and movement are complementary components of maneuver, the antiarmor company commander (or platoon leader) must be able to effectively plan for and mass the direct fires of all available resources at critical locations and times to be successful on the battlefield. Effective and efficient fire control requires the unit to acquire the enemy rapidly and mass the effects of direct fires to achieve decisive results in the close fight.

Section I. PRINCIPLES OF DIRECT FIRE CONTROL

When planning and executing direct fires, the commander and subordinate leaders must know how to apply several fundamental principles. The purpose of these direct fire control principles is not to restrict the actions of subordinates but to help the unit accomplish the primary goal of any direct fire engagement: to eliminate the enemy by acquiring first and shooting first. Applied correctly, these principles give subordinates the freedom to respond rapidly upon acquisition of the enemy. This discussion focuses on the following principles:

- Mass the effects of fire.
- Destroy the greatest threat first.
- Avoid target overkill.
- Employ the best weapon for the target.
- Minimize friendly exposure.
- Prevent fratricide.
- Plan for extreme limited visibility conditions.

C-1. MASS THE EFFECTS OF FIRE

The antiarmor company (or platoon) must mass its direct fires to achieve decisive results. Massing entails focusing direct fires at critical points and distributing the effects. Random application of fires is unlikely to have a decisive effect. For example, concentrating the unit's direct fires at a single target may ensure its destruction or suppression; however, that fire control option will fail to achieve the decisive effect on the enemy formation or position.

C-2. DESTROY THE GREATEST THREAT FIRST

The order in which the antiarmor company (or platoon) engages enemy forces is in direct relation to the danger these forces present. The threat posed by the enemy depends on his weapons, range, and positioning. Presented with multiple targets, a unit must initially concentrate direct fires to destroy the greatest threat, and then distribute fires over the remainder of the enemy force.

C-3. AVOID TARGET OVERKILL

Use only the amount of fire required to achieve necessary effects. Target overkill wastes ammunition and is not tactically sound. To the other extreme, the unit cannot have every weapon system engage a different target because the requirement to destroy the greatest threats first remains paramount.

C-4. EMPLOY THE BEST WEAPON FOR THE TARGET

Using the appropriate weapon system for the target increases the probability of rapid enemy destruction or suppression; at the same time, it conserves ammunition. The antiarmor company (or platoon) has many weapon systems (TOW, M2, or MK19) with which to engage the enemy. Target type, range, and exposure are key factors in determining the weapon system and ammunition that should be employed, as are weapon system and ammunition availability and desired target effects. The antiarmor company commander (or platoon leader) arrays his forces based on the terrain, enemy, and desired effects of all of his available direct fire weapon systems. As an example, when a light infantry battalion antiarmor platoon leader expects an enemy dismounted assault in restricted terrain, he would employ MK19 and M2 in lieu of the TOW, taking advantage of their ability to engage numerous, fast moving dismounted targets. (Refer to Appendix E, TOW Employment in Restricted Terrain.)

C-5. MINIMIZE FRIENDLY EXPOSURE

Units increase their survivability by exposing themselves to the enemy only to the extent necessary to engage him effectively. Natural or manmade defilade provides the best cover from ATGMs and other large caliber direct fire munitions. Dismounted antiarmor squads and vehicles (HMMWV or ICV) minimize their exposure by constantly seeking effective available cover, attempting to engage the enemy from the flank, remaining dispersed, firing from multiple positions, and limiting engagement times.

C-6. PREVENT FRATRICIDE

The antiarmor company commander (or platoon leader) must be proactive in reducing the risk of fratricide and noncombatant casualties. He has numerous tools to assist him in this effort: identification training for combat vehicles and aircraft, the unit's weapons safety posture, the weapons control status, and recognition markings. (Additionally, the SBCT antiarmor company has friendly information embedded within FBCB2). Knowledge and employment of applicable ROE are the primary means of preventing noncombatant casualties. (Refer to Appendix B, Risk Management and Fratricide Avoidance.)

C-7. PLAN FOR EXTREME LIMITED VISIBILITY CONDITIONS

At night, limited visibility fire control equipment enables the antiarmor company (or platoon) to engage enemy forces at nearly the same ranges that are applicable during the day. Obscurants such as dense fog, heavy rain, heavy smoke, and blowing sand, however, can reduce the capabilities of thermal and infrared equipment. Therefore, the company commander (or platoon leader) should develop contingencies for such extreme limited visibility conditions. Typically, firing positions, whether offensive or defensive, must be adjusted closer to the area or point where the commander intends to focus fires. Another

alternative is the use of visual or IR illumination when there is insufficient ambient light for passive light intensification devices.

C-8. DEVELOP CONTINGENCIES FOR DIMINISHED CAPABILITIES

Leaders initially develop plans based on their units' maximum capabilities; they make backup plans for implementation in the event of casualties, weapon damage or failure, or diminished capabilities to gather and share information. While leaders cannot anticipate or plan for every situation, they should develop plans for what they view as the most probable occurrences. Building redundancy into these plans, such as having two weapon systems observe the same sector, is an invaluable asset when the situation (and the number of available weapon systems) permits. Designating alternate sectors of fire provides a means of shifting fires if adjacent elements become unable to fire.

Section II. FIRE CONTROL PROCESS

To bring direct fires against an enemy force successfully, commanders and leaders must continuously apply the four steps of the fire control process. At the heart of this process are two critical actions: rapid, accurate target acquisition and the massing of fires to achieve decisive effects on the target. Target acquisition is the detection, identification, and location of a target in sufficient detail to permit the effective employment of weapons. Massing entails focusing fires at critical points and then distributing the fires for optimum effect. The four steps are--

- Identify probable enemy locations and determine the enemy scheme of maneuver.
- Determine where and how to mass (focus and distribute) fire effects.
- Orient forces to speed target acquisition.
- Shift fires to refocus or redistribute their effects.

C-9. IDENTIFY PROBABLE ENEMY LOCATIONS AND DETERMINE THE ENEMY SCHEME OF MANEUVER

The antiarmor company commander (or platoon leader) plans and executes direct fires based on his analysis of the factors of METT-TC. Essential parts of this are his analyses of the terrain and the enemy force. These analyses aid him in visualizing how the enemy will attack or defend a particular piece of terrain. A defending enemy's defensive position or an attacking enemy's support position is normally driven by terrain. Typically, there are limited points on a piece of terrain that provide both good fields of fire and adequate cover for a defender. Similarly, an attacking enemy will have only a limited selection of avenues of approach that provide adequate cover and concealment. The company commander's (or platoon leader's) understanding of the effects of a specific piece of terrain on maneuver will assist him in identifying probable enemy locations and likely avenues of approach both before and during the fight. Figure C-1, page C-4, illustrates an antiarmor company commander's analysis of enemy locations and scheme of maneuver; he may use any or all of the following products or techniques in developing and updating the analysis:

- A SITEMP provided by his higher headquarters.
- A SPOTREP or contact report on enemy locations and activities.
- Reconnaissance of the AO.

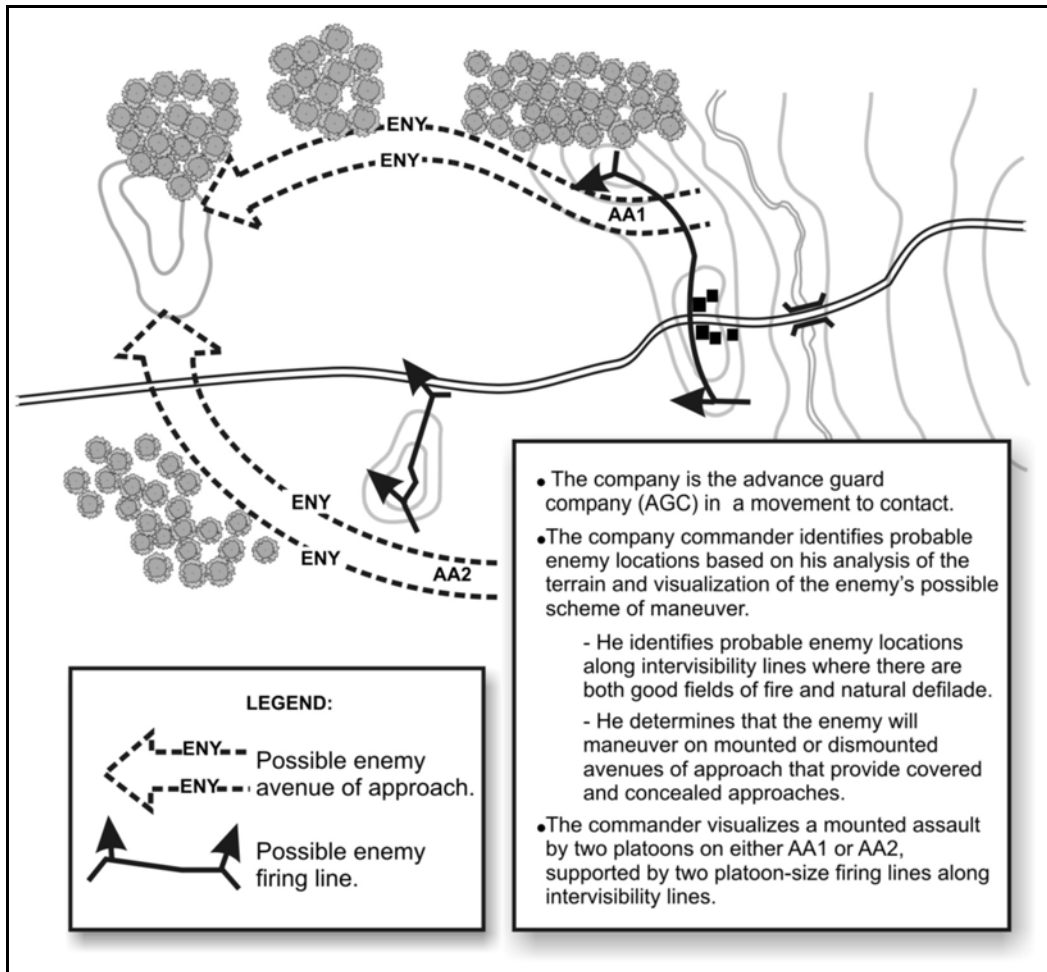

Figure C-1. Example of identifying probable enemy locations and determining enemy scheme of maneuver.

C-10. DETERMINE WHERE AND HOW TO MASS FIRES

To achieve decisive effects the antiarmor company (or platoon) must mass direct fires. Effective massing requires the company commander (or platoon leader) to focus the fires of subordinate elements and to distribute the effects of those fires. Based on his analysis and his concept of the operation, he identifies points where he wants to focus or must focus the unit's direct fires. Most often, he has identified these locations as probable enemy positions or points along likely enemy avenues of approach where the unit can mass direct fires. Because the subordinate units initially may not be oriented on the point where the company commander wants to mass direct fires, he may issue a fire command to focus the direct fires. At the same time, he must use direct fire control measures to effectively distribute the direct fires of his subordinate elements, which are now focused on the same point. Figure C-2 illustrates how a commander masses fires against the enemy.

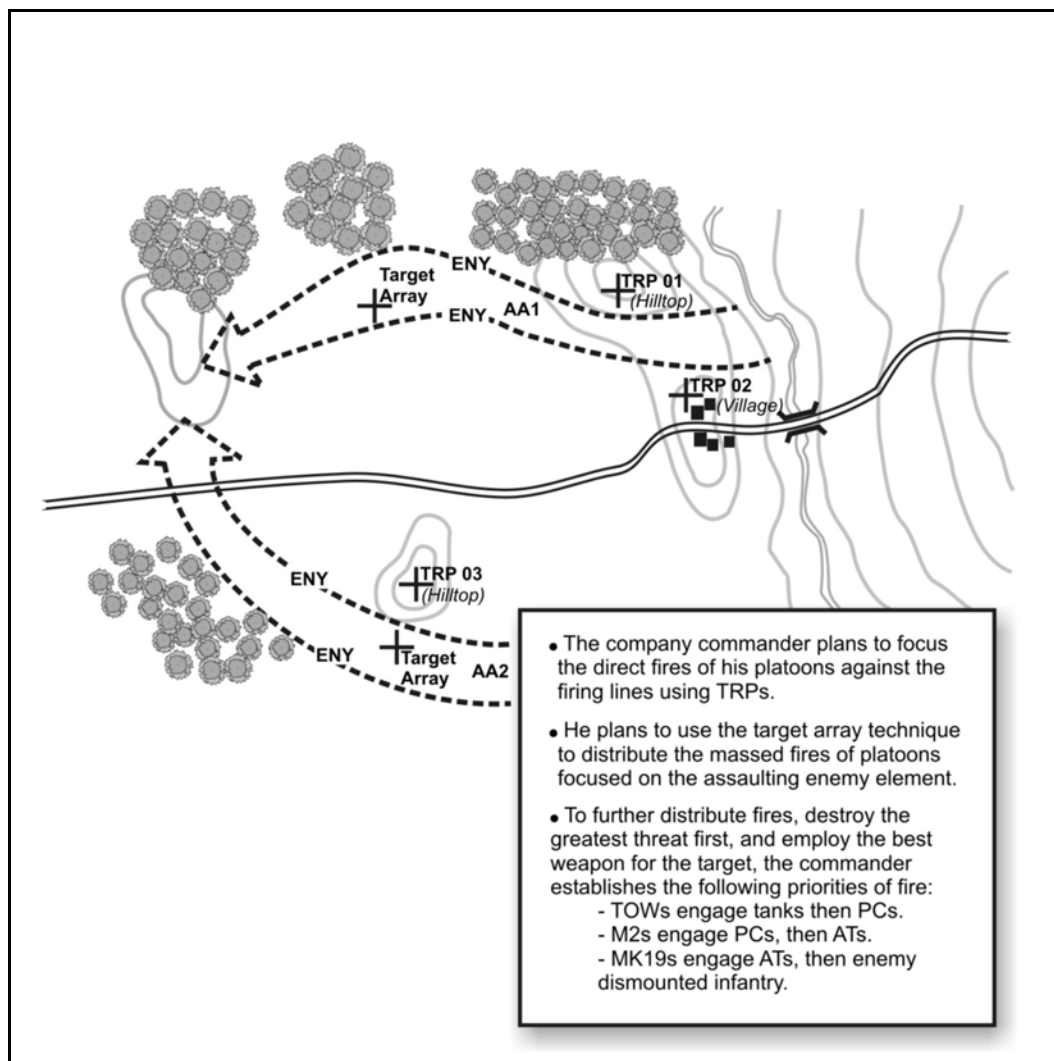

Figure C-2. Example of determining where and how to mass (focus and distribute) fire effects to kill the enemy.

C-11. ORIENT FORCES TO SPEED TARGET ACQUISITION

To engage the enemy with direct fires effectively, the antiarmor company (or platoon) must rapidly and accurately acquire enemy elements. Orienting the unit on probable enemy locations and on likely enemy avenues of approach speeds target acquisition. Conversely, failure to orient the unit results in slower acquisition, which greatly increases the likelihood that enemy forces will be able to engage first. The clock direction orientation method, which is prescribed in most unit SOPs, is good for achieving all-round security; however, it does not ensure that friendly forces are most effectively oriented to detect the enemy. To achieve this critical orientation, the commander (or platoon leader) typically designates TRPs on or near a probable enemy location or avenues of approach; he orients his subordinate units using directions of fire or sectors of fire. Normally, some antiarmor squads scan the designated direction, sector, or area while others observe alternate sectors or areas to provide all-round security. In the SBCT, the antiarmor company commander receives information that enhances the COP displayed on

FBCB2. However, he may use the previously described methods to reinforce information provided by FBCB2. Figure C-3 illustrates how an antiarmor company commander orients the company for quick, effective acquisition of the enemy force.

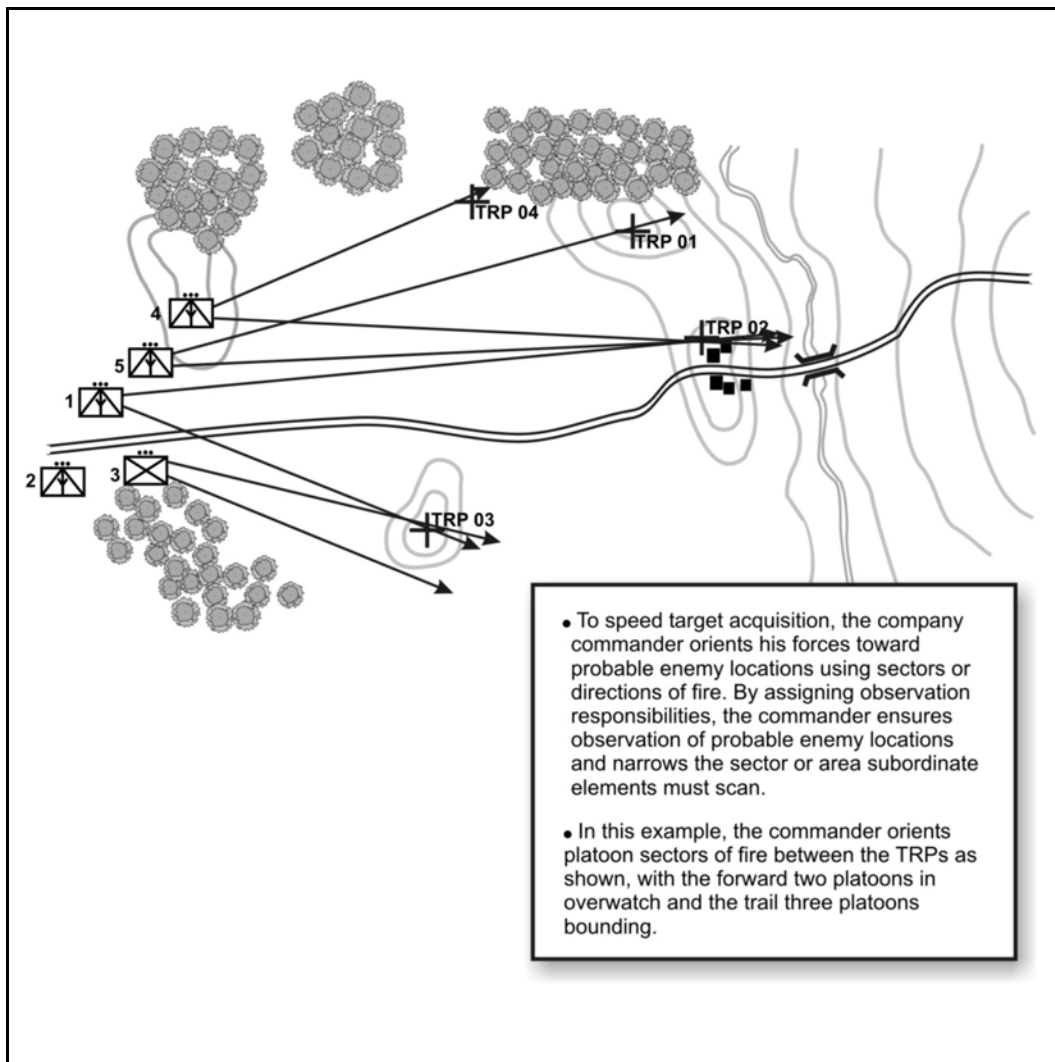

Figure C-3. Example of orienting forces to speed target acquisition.

C-12. SHIFT FIRES TO REFOCUS AND REDISTRIBUTE

As the engagement proceeds, leaders must shift direct fires to refocus and redistribute the effects based on evolving friendly and enemy information. Figure C-4 provides an example of shifting to refocus and redistribute fires. Situational understanding is an essential part of the fire control process at this point. The antiarmor company commander (or platoon leader) and his subordinate leaders apply the same techniques and considerations, including fire control measures, which they used earlier to focus and distribute fires. A variety of situations will dictate shifting of fires, including the following:

- Appearance of an enemy force posing a greater threat than the one currently being engaged.
- Extensive destruction of the enemy force being engaged, creating the possibility of target overkill.
- Destruction of friendly elements that are engaging the enemy force.
- Change in the ammunition status of friendly elements that are engaging the enemy force.
- Maneuver of enemy or friendly forces resulting in terrain masking.
- Increased fratricide risk as a maneuvering friendly element closes with the enemy force being engaged.

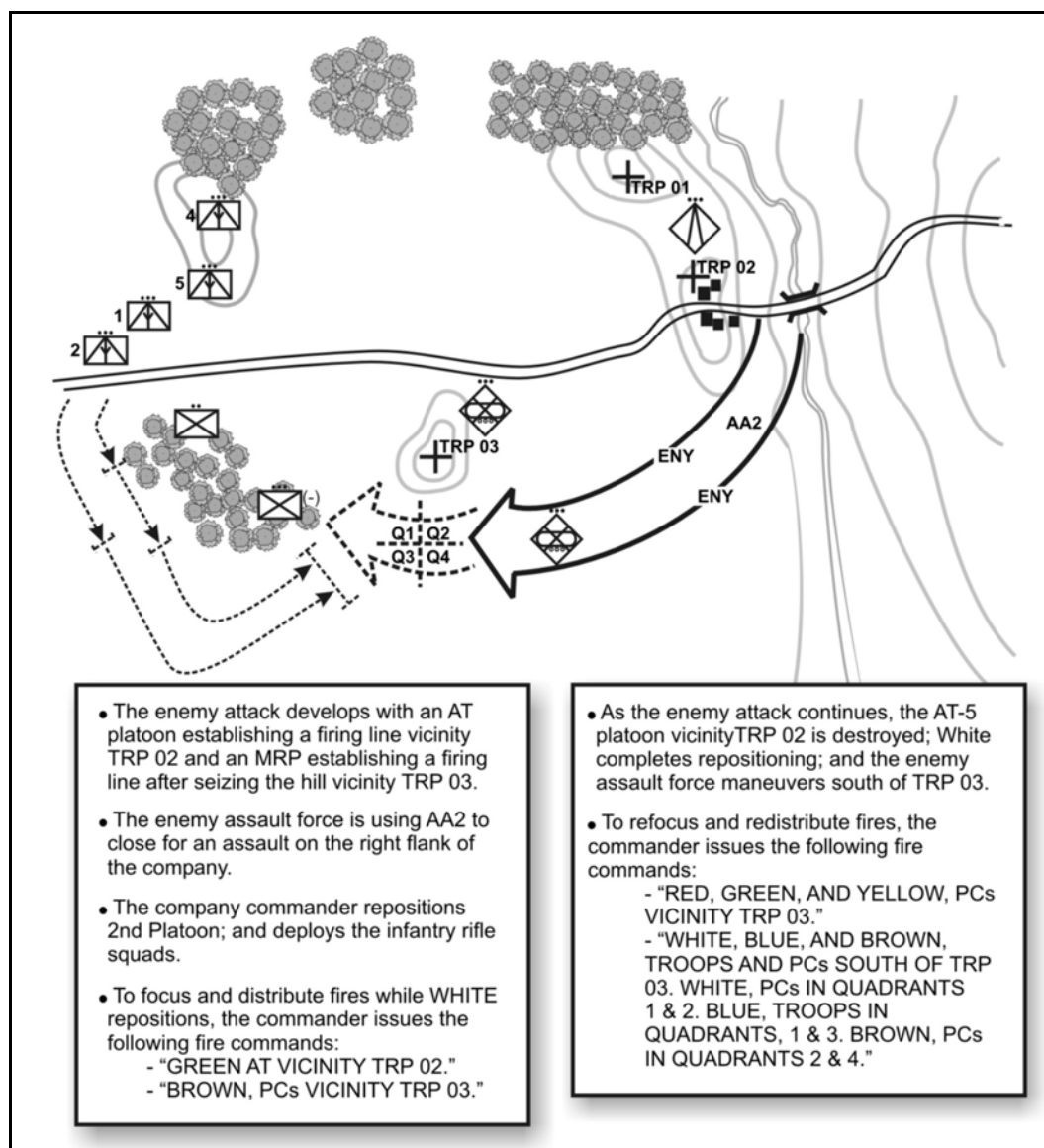

Figure C-4. Example of shifting to refocus and redistribute fires.

Section III. DIRECT FIRE PLANNING

The antiarmor company commander (or platoon leader) plans direct fires concurrent with his troop-leading procedures. Determining where and how the unit can and will mass fires is an essential step as he develops his concept of the operation.

C-13. PLANNING DIRECT FIRES

After identifying probable (or known) enemy locations, the company commander (or platoon leader) determines points or areas where he will focus his combat power. His visualization of where and how the enemy will attack or defend assists him in determining the volume of fires he must focus at particular points to have a decisive effect. In addition, if he intends to mass the direct fires of more than one subordinate unit, he must establish a means for distributing those fires effectively.

a. Based on where and how he wants to focus and distribute direct fires, the company commander (or platoon leader) can establish the weapons ready postures for his subordinate elements as well as triggers for initiating fires. He must evaluate the risk of fratricide and establish controls to avoid it. Fratricide avoidance measures include designation of recognition markings, weapons control status, and weapons safety posture. (See Appendix B for more information.)

b. Having determined where and how he will mass and distribute direct fires, the company commander (or platoon leader) must orient subordinate units so they can rapidly and accurately acquire the enemy. He must anticipate how the enemy will fight. He gains this anticipation through a detailed war game of the selected course of action to determine probable requirements for refocusing and redistributing fires and to establish other necessary controls. Also during the TLP, he plans and conducts rehearsals of direct fires (and of the fire control process) based on his analysis.

c. The company commander (or platoon leader) must continue to apply planning procedures and considerations throughout execution. He must be able to adjust direct fires based on combining the latest available information. When necessary, he must also apply effective direct fire SOPs.

C-14. DIRECT FIRE SOP

A well-rehearsed direct fire SOP enhances direct fire planning and ensures quick, predictable actions by all members of the unit. The antiarmor company commander (or platoon leader) bases the various elements of the SOP on the capabilities of his force and on anticipated conditions and situations. SOP elements should include methods of focusing fires, distributing their effects, orienting forces, and preventing fratricide. He adjusts the direct fire SOP when changes to anticipated and actual factors of METT-TC become apparent.

a. **Focusing Fires.** TRPs are a common means of focusing fires. One technique is to establish a standard respective position for TRPs in relation to friendly elements and then to consistently number the TRPs, such as from left to right. This allows leaders to quickly determine and communicate the location of the TRPs. FBCB2 enhances the SBCT antiarmor company commander's ability to focus the direct fires of his platoons. However, FBCB2 still requires some augmentation to assist him in focusing those direct fires.

b. **Distributing Fires.** Two useful means of distributing the effects of the unit's direct fires are engagement priorities and target array. Engagement priorities, by type of enemy vehicle or weapon system, are assigned for each type of friendly weapon system. The target array technique can assist in distribution by assigning specific friendly elements to engage enemy elements of approximately similar capabilities. The following are example of SOP elements for distributing the fires of an antiarmor company:

- MK19s engage antitank weapons first, then troops.
- M2s engage medium-armored vehicles first, then trucks.
- TOWs engage tanks first, then other armored vehicles.

c. **Orienting Forces.** A standard means of orienting friendly forces is to assign a primary direction of fire, using a TRP, to orient each subordinate element on a probable (or known) enemy position or likely avenue of approach. To provide all-round security, the SOP can supplement the primary direction of fire with sectors using a friendly-based quadrant. The following example of SOP elements for an antiarmor company illustrate the use of these techniques:

- The lead platoon's primary direction of fire is TRP 2 (center) until otherwise specified; the platoon is responsible for the front two quadrants.
- The left flank platoon's primary direction of fire is TRP 1 (left) until otherwise specified; the platoon is responsible for the left two friendly quadrants (overlapping with the lead platoon).
- The right flank platoon's primary direction of fire is TRP 3 (right) until otherwise specified; the platoon is responsible for the right two friendly quadrants (overlapping with the lead platoon).
- The center platoon's primary direction of fire is TRP 1 (left) until otherwise specified; the platoon is responsible for the bottom left friendly quadrant (overlapping with the left platoon).
- The trail platoon's primary direction of fire is TRP 3 (right) until otherwise specified; the platoon is responsible for the bottom right friendly quadrant (overlapping with the right platoon).

d. **Avoiding Fratricide.** The direct fire SOP must address the most critical requirement of fratricide avoidance. It must direct subordinate leaders to inform the commander, adjacent elements, and subordinates whenever a friendly force is moving or preparing to move. One technique is to establish a standing weapons control status of WEAPONS TIGHT, which requires positive enemy identification prior to engagement. The SOP must also cover methods for identifying friendly dismounted elements. These techniques include using armbands, medical heat pads, or an IR light source, as well as detonating a smoke grenade of a designated color at the appropriate time. A good tool for minimizing the risk of fratricide in the SBCT antiarmor company is through FBCB2; however, this does not supplant the company commander's responsibility to plan for fratricide avoidance.

Section IV. DIRECT FIRE CONTROL

Acquiring the enemy is a precursor to direct fire engagement. The company commander (or platoon leader) must expect the enemy to use cover and concealed routes effectively when attacking and to make best use of flanking and concealed positions in the defense. As a result, the company (or platoon) may not have the luxury of a fully exposed enemy that can be easily seen. The acquisition of the enemy often depends on visual recognition of subtle indicators such as exposed antennas, reflections from the vision blocks of enemy vehicles, small dust clouds, or smoke from vehicle engines or ATGM or tank fires. Because of the difficulty of target acquisition, the company commander (or platoon leader) must develop surveillance plans to assist the unit in acquiring the enemy.

C-15. FIRE CONTROL MEASURES

Fire control measures provide the means by which the antiarmor company commander (or platoon leader) or his subordinate leaders control direct fires. Application of these concepts, procedures, and techniques assists the unit in acquiring the enemy, focusing fires on him, distributing the effects of the fires, and preventing fratricide. At the same time, no single measure is sufficient to control fires effectively. At company level, fire control measures are effective only if the entire unit has a common understanding of what they mean and how to employ them. Table C-1 lists terrain-based and threat-based fire control measures.

Terrain-Based Fire Control Measures	Threat-Based Fire Control Measures
Target reference point	Fire patterns
Engagement area	Target array
Sector of fire	Engagement priorities
Direction of fire	Weapons ready posture
Terrain-based quadrant	Engagement criteria
Friendly-based quadrant	Weapons control status
Maximum engagement line	Rules of engagement
Restrictive fire line	Weapons safety posture
Final protective line	Engagement techniques

Table C-1. Common fire control measures.

a. **Terrain-Based Fire Control Measures.** The antiarmor company commander (or platoon leader) uses terrain-based fire control measures to focus and control fires on a particular point, line, or area rather than on a specific enemy element. The following paragraphs describe the techniques associated with this type of control measure.

(1) **Target Reference Point.** A target reference point is an easily recognizable point on the ground that leaders use to orient friendly forces and to focus and control direct fires. In addition, when TRPs are designated as indirect fire targets, they can be used to call for and adjust indirect fires. Leaders designate TRPs at probable (or known) enemy locations and along likely avenues of approach. These points can be natural or manmade. A TRP can be an established site, such as a hill or a building, or an impromptu feature designated as a TRP on the spot, like a burning enemy vehicle or smoke generated by an artillery round. Ideally, TRPs should be visible in three observation modes (unaided, passive-IR, and thermal) so all forces can identify them. Examples of TRPs include the following features and objects:

- Prominent hill mass.
- Distinctive building.
- Observable enemy position.
- Destroyed vehicle.
- Ground-burst illumination.
- Smoke round.
- Laser point.

(2) **Engagement Area.** This fire control measure is an area along an enemy avenue of approach where the company commander (or platoon leader) intends to mass the direct fires of available weapon systems to destroy an enemy force. The size and shape of the EA is determined by the degree of relatively unobstructed visibility available to the unit's weapon systems in their firing positions and by the maximum range of those systems. Typically, company commanders (or platoon leaders) delineate responsibility within the EA by assigning each subordinate unit a sector of fire or direction of fire. These fire control measures are covered in the following paragraphs.

(3) **Sector of Fire.** A sector of fire is a defined area that must be covered by direct fire. Leaders assign sectors of fire to subordinate elements, weapon systems, and individual soldiers to ensure coverage of an area of responsibility. They may also limit the sector of fire of an element or weapon system to prevent accidental engagement of an adjacent unit. In assigning sectors of fire, commanders and subordinate leaders consider the number and types of weapon systems available. In addition, they must consider acquisition system type and field of view in determining the width of a sector of fire. For example, while unaided vision has a wide field of view, its ability to detect and identify targets at distant ranges and in limited visibility conditions is restricted. Conversely, most fire control acquisition systems have greater detection and identification ranges than the unaided eye, but their field of view is narrow. Means of designating sectors of fire include the following:

- TRPs.
- Clock direction.
- Terrain-based quadrants.
- Friendly-based quadrants.

(4) **Direction of Fire.** A direction of fire is an orientation or point used to assign responsibility for a particular area on the battlefield that must be covered by direct fire. Leaders designate directions of fire for the purpose of acquisition or engagement by subordinate elements, weapon systems, or individual soldiers. Direction of fire is most commonly employed when assigning sectors of fire would be difficult or impossible because of limited time or insufficient reference points. Means of designating a direction of fire include the following:

- Closest TRP.
- Clock direction.
- Cardinal direction.
- Tracer on target.
- IR laser pointer.

(5) **Quadrants.** Quadrants are subdivisions of an area created by superimposing imaginary perpendicular axes over the terrain to create four separate areas, or quadrants.

Quadrants can be based on the terrain, on friendly forces, or on the enemy formation. The technique in which quadrants are based on the enemy formation is usually referred to as the “target array” and is covered in threat-based fire control measures (paragraph C-15b). The method of identifying quadrants is established in the unit SOP; however, care must be taken to avoid confusion when quadrants based on terrain, friendly forces, and enemy formations (target array) are used simultaneously.

(a) *Terrain-Based Quadrant.* A terrain-based quadrant entails the use of a TRP, either existing or constructed, to designate the center point of the axes that divide the area into four quadrants. This technique can be employed in both offensive and defensive operations. In the offense, for example, the company commander designates the center of the quadrant by using an existing feature or by creating a reference point (using a ground burst illumination round, a smoke marking round, or a fire ignited by incendiary or tracer rounds). The axes delineating the quadrants run parallel and perpendicular to the direction of movement. In the defense, for example, the company commander designates the center of the quadrant using an existing or constructed TRP. In the examples shown in Figure C-5, quadrants are marked using the letter "Q" and a number (Q1 to Q4); quadrant numbers are in the same relative positions as on military map sheets (from Q1 as the upper left quadrant clockwise to Q4 as the lower left quadrant).

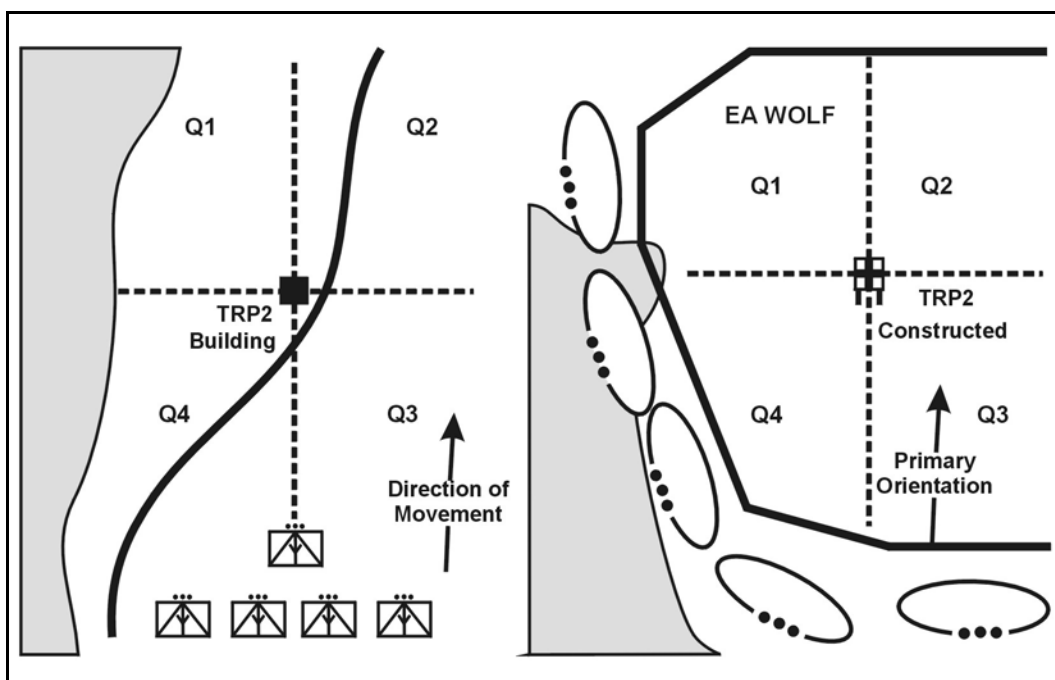

Figure C-5. Examples of terrain-based quadrants.

(b) *Friendly-Based Quadrant.* The friendly-based quadrant technique entails superimposing quadrants over the unit's formation. The center point is based on the center of the formation, and the axes run parallel and perpendicular to the general direction of travel. The friendly quadrant technique may be better than the clock direction method for rapid orientation because the different elements of a large formation are rarely oriented in the same exact direction and because the relative dispersion of friendly forces

causes parallax to the target. Figure C-6 illustrates an antiarmor platoon's use of friendly-based quadrants.

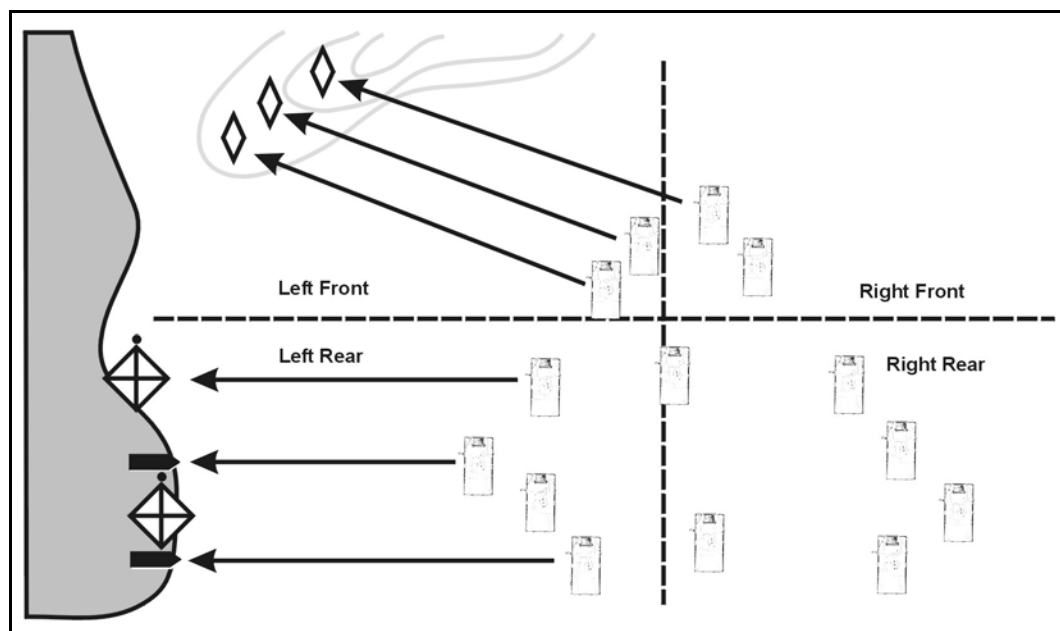

Figure C-6. Example of friendly-based quadrants.

(6) **Maximum Engagement Line.** A maximum engagement line is the linear depiction of the farthest limit of effective fire for a weapon system or unit. This line is determined both by the maximum effective range of a weapon or a unit and by the effects of terrain. For example, slope, vegetation, structures, and other features provide cover and concealment that may prevent the weapon from engaging out to the maximum effective range. A MEL serves several purposes. A platoon leader may use it to prevent vehicles (or antiarmor squads) from engaging beyond the maximum effective range of their weapon systems, to define criteria for the establishment of triggers, and to delineate the maximum extent of the sector sketch.

(7) **Restrictive Fire Line.** A restrictive fire line is a line established between converging friendly forces (one or both may be moving) that prohibits fires and effects across the line without coordination with the affected force. The higher common commander establishes the RFL. In the offense, for example, an antiarmor company commander may designate an RFL to prevent a base-of-fire force from firing into the area where an assaulting force is maneuvering. This technique is particularly important when an antiarmor unit supports the maneuver of infantry forces. In the defense, for example, an antiarmor company commander may establish an RFL to prevent the unit from engaging an infantry force positioned in restricted terrain on the flank of an enemy avenue of approach.

(8) **Final Protective Line.** The final protective line (FPL) is a line of fire established where an enemy assault is to be checked by the interlocking fires of all available weapon systems. The unit reinforces this line with protective obstacles and with FPFs whenever possible. Initiation of the FPF is the signal for elements, antiarmor squads, and individual

soldiers to shift fires to their assigned portion of the FPL. They spare no ammunition in repelling the enemy assault.

b. **Threat-Based Fire Control Measures.** The antiarmor company commander (or platoon leader) uses threat-based fire control measures to focus and control direct fires by directing the unit to engage a specific enemy element rather than to fire on a point or area. The following paragraphs describe the techniques associated with this type of fire control measure.

(1) **Fire Patterns.** Fire patterns are a threat-based fire control measure designed to distribute the fires of a unit simultaneously among multiple, similar targets. They are most often used by platoons to distribute fires across an enemy formation. Leaders designate and adjust fire patterns based on terrain and the anticipated enemy formation. The basic fire patterns, illustrated in Figure C-7, are--

- Frontal fire.
- Cross fire.
- Depth fire.

(a) *Frontal Fire.* Leaders may initiate frontal fire when targets are arrayed in front of the unit in a lateral configuration. Weapon systems engage targets to their respective fronts. For example, the left flank weapon engages the left-most target; the right flank weapon engages the right-most target. As the unit destroys targets, weapons shift fires toward the center of the enemy formation and from near to far.

(b) *Cross Fire.* Leaders initiate cross fire when targets are arrayed laterally across the unit's front in a manner that permits diagonal fires at the enemy's flank or when obstructions prevent the unit's weapon systems from firing frontally. Right flank weapons engage the left-most targets; left flank weapons engage the right-most targets. Firing diagonally across an engagement area provides more flank shots, thus increasing the chance of kills; it also reduces the possibility that friendly elements will be detected if the enemy continues to move forward. As the unit destroys targets, weapons shift fires toward the center of the enemy formation.

(c) *Depth Fire.* Leaders initiate depth fire when targets are dispersed in depth, perpendicular to the unit. Center weapons engage the closest targets; flank weapons engage deeper targets. As the unit destroys targets, weapons shift fires toward the center of the enemy formation.

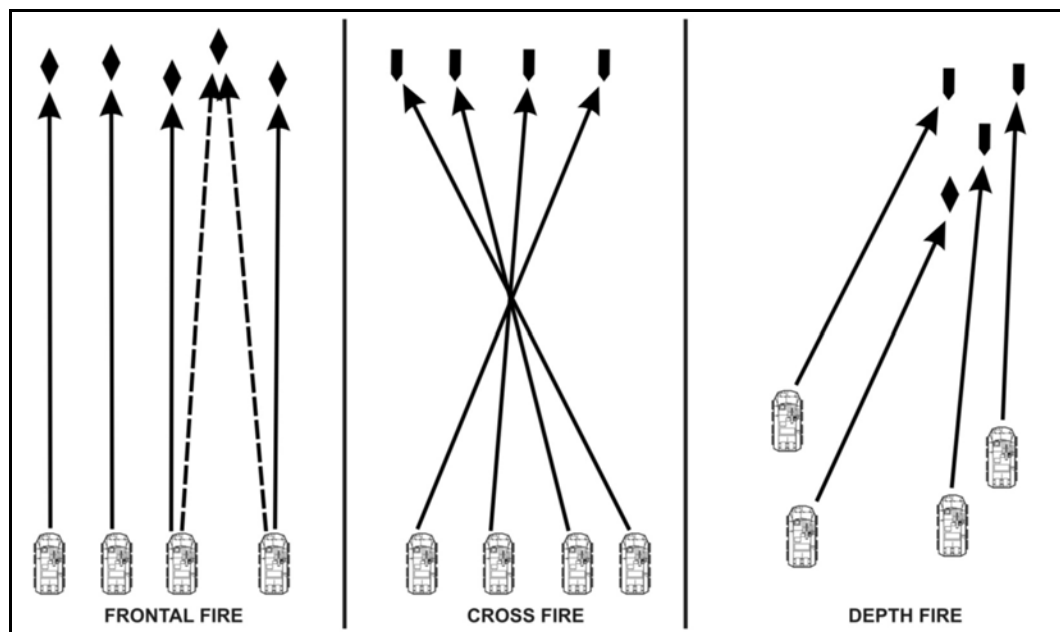

Figure C-7. Examples of fire patterns.

(2) **Target Array.** Target array permits the antiarmor company commander (or platoon leader) to distribute direct fires when the enemy force is concentrated and terrain-based controls are inadequate. This threat-based distribution measure is similar to the quadrant method mentioned in terrain-based fire control measures (paragraph C-15a). The company commander (or platoon leader) creates the target array by superimposing a quadrant pattern over an enemy formation. The pattern is centered on the enemy formation, with the axes running parallel and perpendicular to the enemy's direction of travel. Quadrants are described using their relative locations. The examples in Figure C-8, page C-16, illustrate the target array technique.

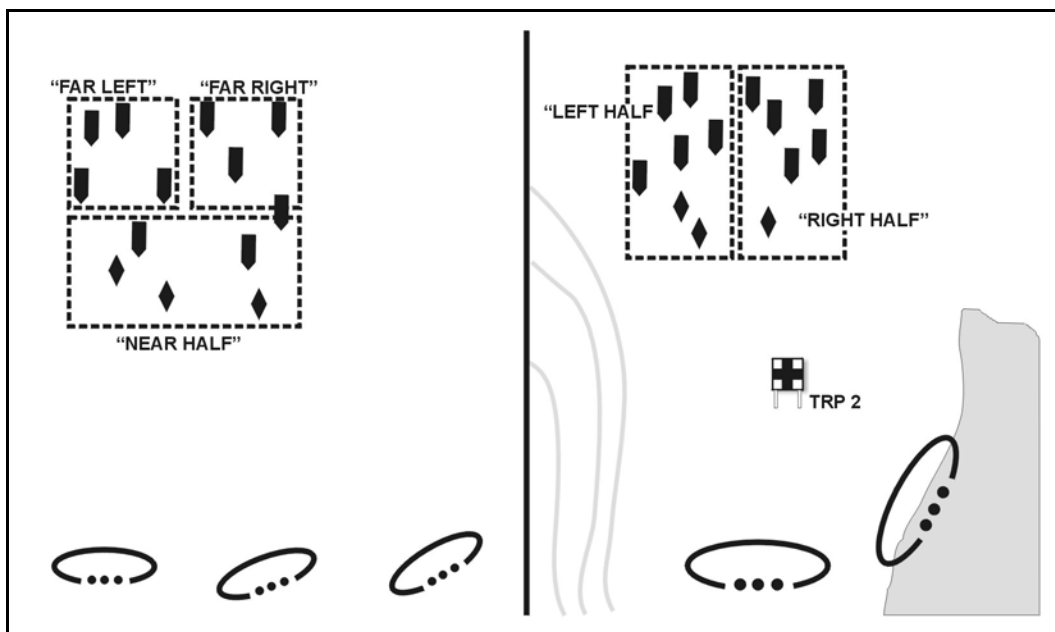

Figure C-8. Examples of target array.

(3) **Engagement Priorities.** Engagement priorities entail the sequential ordering of targets to be engaged. They serve one or more of the following critical fire control functions:

(a) *Prioritize Targets.* In concert with his concept of the operation, the company commander (or platoon leader) determines which target types provide the greatest threat to the unit; he can then set these as an engagement priority. For example, he may decide that destroying enemy engineer assets is the best way to prevent the enemy from breaching an obstacle.

(b) *Employ the Best Weapons for the Target.* Establishing engagement priorities for specific friendly weapon systems increases the effectiveness with which the unit employs its weapons. As an example, the engagement priority for the unit's TOWs could be enemy armored vehicles first, then enemy fortifications. This would decrease the chance that the company's MK19s or M2s will need to engage enemy armored vehicles.

(c) *Distribute the Unit's Fires.* Establishing different priorities for similar friendly weapon systems helps to prevent overkill and achieve effective distribution of fires. For example, an antiarmor company commander may designate the enemy fortifications as the initial priority for one platoon while making the enemy vehicles the priority for another platoon. This would decrease the chance of multiple TOWs being fired against two enemy vehicles while ignoring the dangers posed by the fortifications.

(4) **Weapons Ready Posture.** The weapons ready posture is a means by which leaders use situational understanding to specify the ammunition and range for the most probable engagement. Ammunition selection depends on the target type, but the leader may adjust it based on engagement priorities, desired effects, and effective range. Range selection depends on the anticipated engagement range and is affected by terrain inter-visibility, weather, and light conditions. Within an antiarmor company, the weapons ready posture affects the types and quantities of ammunition loaded and stowed in ready racks.

(5) **Engagement Criteria.** Engagement criteria are a specific set of conditions that specify the circumstances in which subordinate elements are to engage. This is often referred to as a “trigger.” The circumstances can be based on a friendly or an enemy event. For example, the engagement criteria for an antiarmor platoon to initiate fires could be three or more enemy combat vehicles passing or crossing a given point or line. This line can be any natural or manmade linear feature, such as a road, ridgeline, or stream. It may also be a line perpendicular to the unit’s orientation, delineated by one or more reference points.

(6) **Weapons Control Status.** The three weapons control status levels outline the conditions, based on target identification criteria, under which friendly elements may engage. The company commander (or platoon leader) sets and adjusts the WCS based on friendly and enemy disposition and situational understanding. In general, a more restrictive WCS relates to a higher probability of fratricide. The three levels, in descending order of restriction, are--

- WEAPONS HOLD. Engage only if engaged or ordered to engage.
- WEAPONS TIGHT. Engage only targets positively identified as enemy.
- WEAPONS FREE. Engage any targets not positively identified as friendly.

As an example, an antiarmor company commander may establish the WCS as WEAPONS HOLD when friendly forces are conducting a passage of lines. The company commander may be able to set a WEAPONS FREE status when he knows there are no friendly elements in the vicinity of the engagement. This WCS permits his elements to engage targets at extended ranges even though it is difficult to distinguish the targets accurately under battlefield conditions.

(7) **Rules of Engagement.** ROE specify the circumstances and limitations under which forces may engage. ROE include definitions of combatant and noncombatant elements and prescribe the treatment of noncombatants. Factors influencing ROE are national command policy, the mission and commander’s intent, the operational environment, and the law of war. ROE always recognize a soldier’s right of self-defense; at the same time, they clearly define circumstances in which he may fire.

(8) **Weapons Safety Posture.** Weapons safety posture is an ammunition handling instruction that allows the antiarmor company commander (or platoon leader) to precisely control the safety of his unit’s weapons. Leaders supervise the weapons safety posture and soldier adherence to it, minimizing the risk of accidental discharge and fratricide. Table C-2, page C-18, outlines procedures and considerations for an antiarmor company in using the four weapons safety postures, listed in ascending order of restriction:

- AMMUNITION LOADED.
- AMMUNITION LOCKED.
- AMMUNITION PREPARED.
- WEAPONS CLEARED.

In setting and adjusting the weapons safety posture, the antiarmor company commander must weigh the desire to prevent accidental discharges against the requirement for immediate action based on the enemy threat. If the possibility of direct contact with the enemy is high, for example, he may establish the weapons safety posture as AMMUNITION LOADED. If the requirement for action is less immediate, he may lower the posture to AMMUNITION LOCKED or AMMUNITION PREPARED. Additionally, the antiarmor company commander may designate different weapons safety postures for

different elements of the unit. For example, in the attack position, TOW-equipped platoons may switch to AMMUNITION LOADED while MK19-equipped and M2-equipped platoons remain at AMMUNITION LOCKED.

	TOW WEAPONS AND AMMUNITION	MK19 WEAPONS AND AMMUNITION	M2 WEAPONS AND AMMUNITION
AMMUNITION LOADED	TOW missile loaded in launcher and system self-test completed. Self-defense weapon ammunition on feed tray; bolt locked to rear (ICV only). Smoke grenades in launchers (ICV only). Weapon on safe.	40mm ammunition on MK19 feed tray; bolt locked to rear. Weapon on safe.	Cal .50 ammunition on M2 feed tray; bolt locked to rear. Weapon on safe.
AMMUNITION LOCKED	TOW ammunition loaded in launcher. Self-defense weapon ammunition on feed tray; bolt forward (ICV only). Smoke grenades in launchers (ICV only). Weapon on safe.	40mm ammunition on MK19 feed tray; bolt forward. Weapon on safe.	Cal .50 ammunition on M2 feed tray; bolt forward. Weapon on safe.
AMMUNITION PREPARED	TOW missile ready rack filled. Self-defense weapon ammunition boxes filled (ICV only). Smoke grenades in launchers (ICV only).	40mm ammunition ready boxes filled.	Cal .50 ammunition ready boxes filled.
WEAPONS CLEARED	TOW missile ready rack filled. Self-defense weapon cleared, with bolts locked to the rear (ICV only).	MK19 cleared, with bolt locked to the rear.	M2 cleared, with bolt locked to the rear.

Table C-2. Weapons safety posture levels.

(9) *Engagement Techniques.* Engagement techniques are effects-oriented direct fire distribution measures. The following engagement techniques are the most common in antiarmor company (or platoon) operations:

- Point fire.
- Area fire.
- Alternating fire.
- Sequential fire.
- Simultaneous fire.
- Observed fire.
- Time of suppression.
- Reconnaissance by fire.

(a) *Point Fire.* Point fire concentrates the effects of a unit’s direct fire against a specific, identified target such as a vehicle, machine gun bunker, or ATGM position. When leaders direct point fire, all of the unit’s weapon systems engage the target, firing until it is destroyed or the required time of suppression has expired. Employing converging fires from dispersed positions makes point fire more effective because the target is engaged from multiple directions. The unit may initiate an engagement using

point fire against the most dangerous threat, then revert to area fire against other, less threatening targets.

(b) *Area Fire*. Area fire involves distributing the effects of a unit's direct fires over an area in which enemy positions are numerous or are not obvious. If the area is large, leaders assign sectors of fire to subordinate elements using a terrain-based distribution method such as the quadrant technique. Typically, the primary purpose of the area fire is suppression; however, sustaining effective suppression requires judicious control of the rate of fire.

(c) *Alternating Fire*. In alternating fire, pairs of elements continuously engage the same point or area target one at a time. For example, an antiarmor company may alternate the direct fires of two platoons; an antiarmor platoon may alternate the fires of its sections. Alternating fire permits the unit to maintain suppression for a longer duration than does simultaneous fire. It also forces the enemy to acquire and engage alternating points of fire.

(d) *Sequential Fire*. In sequential fire, the subordinate elements of a unit engage the same point or area target one after another in an arranged sequence. For example, an antiarmor platoon may sequence the fires of its four vehicles to gain maximum time of suppression. Sequential fire can also help prevent the waste of ammunition, as when an antiarmor platoon waits to see the effects of the first rounds of a MK19 fired before firing another. Additionally, sequential fire permits elements that have already fired to pass on information they have learned from the engagement. An example would be an antiarmor squad that missed a BMP with TOW fires passing range and lead information to the next antiarmor squad preparing to engage the BMP with a TOW.

(e) *Simultaneous Fire*. Units employ simultaneous fire, commonly referred to as "volley fire," to rapidly mass the effects of their direct fires or to gain immediate fire superiority. For example, an antiarmor platoon may initiate a support-by-fire operation with simultaneous fire, then change to alternating or sequential fire to maintain effective suppression.

(f) *Observed Fire*. Observed fire is normally used when an antiarmor company is in concealed defensive positions with engagement ranges in excess of 3,000 meters. It can be employed between elements of the company, such as one antiarmor platoon observing while another antiarmor platoon fires, or between vehicles of an antiarmor platoon. The company commander or platoon leader directs an antiarmor element, an attached infantry squad, or a vehicle to engage. The remaining elements or vehicles observe fires and prepare to engage on order in case the engaging element consistently misses its targets, experiences a malfunction, or runs low on ammunition. Observed fire allows for mutual observation and assistance while protecting the location of the observing elements.

(g) *Time of Suppression*. Time of suppression is the period, specified by a commander (or platoon leader), during which an enemy position or force is to be suppressed. Suppression time typically depends on the time it will take the supported element to maneuver. Normally, a unit suppresses an enemy position using the sustained rate of fire of its weapons. In planning for sustained suppression, leaders must consider several factors: the estimated time of suppression, the size of the area being suppressed, the type of enemy force to be suppressed, range to the target, rates of fire, and available ammunition type and quantities.

(h) *Reconnaissance by Fire*. Reconnaissance by fire is the process of engaging possible enemy locations to elicit a tactical response, such as return fire or movement. This response permits a commander and his subordinate leaders to make accurate target acquisition and then to mass direct fires against the enemy element. Typically, an antiarmor company commander directs a platoon to conduct the reconnaissance by fire. For example, he may direct an overwatching platoon to conduct the reconnaissance by fire with M2 or MK19 against a probable enemy position before initiating TOW fires or movement by a bounding force. Reconnaissance by fire should be used only if the commander is unable to gain an accurate understanding of the situation.

C-16. FIRE COMMANDS

Fire commands are oral orders issued by the company commander and his subordinate leaders to focus and distribute direct fires as required to achieve the desired effects against an enemy force. Fire commands allow leaders in the already confusing environment of close combat to articulate their firing instructions rapidly and concisely using a standard format. Unit fire commands include these elements:

- Alert.
- Weapon or ammunition (optional).
- Target description.
- Orientation.
- Range (optional).
- Control (optional).
- Execution.

a. **Alert.** The alert specifies the units that are directed to fire. It does not require the leader initiating the command to identify himself. Examples of the alert element (call signs and code words based on unit SOP) include --

- "GUIDONS" (all subordinate elements).
- "RED" (1st platoon only).

b. **Weapon or Ammunition (Optional).** This element identifies the weapon and ammunition to be employed by the alerted units. Leaders may designate the type and number of rounds to limit expenditure of ammunition. Examples of this element include the following:

- "MK19."
- "ONE ROUND TOW 2B."

c. **Target Description.** Target description designates which enemy forces are to be engaged. Leaders may use the description to focus fires or achieve distribution. Examples of target description include the following:

- "THREE PCs."
- "BUNKER."
- "TROOPS IN TRENCH."

d. **Orientation.** This element identifies the location of the target. There are numerous ways to designate the location of target, including --

- Closest TRP. Example: "TRP 13."
- Clock direction. Example: "ONE O'CLOCK."
- Terrain quadrant. Example: "QUADRANT ONE."

- Friendly quadrant. Example: "LEFT FRONT."
- Target array. Example: "FRONT HALF."
- Laser pointer (if equipped). Example: "ON MY POINTER."

e. **Range (Optional).** The range element identifies the distance to the target. Announcing range is not necessary for systems that have range finders or that employ command-guided or self-guided munitions. For systems that require manual range settings, leaders have a variety of means for determining range, including the following:

- Predetermined ranges to TRPs or phase lines.
- A TOW-equipped platoon announcing the range for an MK19-equipped platoon.
- Handheld range finders.
- Range stadia.
- Mil reticles.

f. **Control (Optional).** The commander may use this optional element to direct desired target effects, distribution methods, or engagement techniques. Subordinate leaders may include the control element to supplement the commander's instructions and achieve effective distribution. Examples of information specified in the control element include the following:

- Target array. Example: "FRONT HALF."
- Fire pattern. Example: "FRONTAL."
- Terrain quadrant. Example: "QUADRANT ONE."
- Engagement priorities. Example: "TOWs ENGAGE PCs; MK19s ENGAGE TROOPS."
- Engagement technique. Example: "ALTERNATING."
- Target effect. Example: "AREA."

g. **Execution.** The execution element specifies when direct fires will be initiated. The commander may engage immediately, delay initiation, or delegate authority to engage. Examples of this element include the following:

- "FIRE."
- "AT MY COMMAND."
- "AT YOUR COMMAND."
- "AT PHASE LINE ORANGE."

APPENDIX D

FIRING POSITIONS

A firing position must provide protection for the weapon system and its crew, but it also must allow for unhindered target engagement. Due to the fluid nature of offensive operations, occupation of an unprepared defilade position normally characterizes antiarmor fighting positions. While platoons and sections move, their leaders search for these firing positions and the best covered and concealed routes to them. When the leaders cannot make a visual reconnaissance of the terrain, they select tentative firing positions and routes from a thorough map reconnaissance. In the defense, antiarmor squads use firing positions with improved frontal and overhead protection. As the defender, they have more time to learn the terrain and to increase their protection and concealment.

D-1. PLANNING

In the offense, antiarmor units employ their weapon (TOW, M2, or MK19) on the weapon system carrier (either the HMMWV or the ICV). In the defense, antiarmor units employ these weapons either mounted or dismounted. Leaders make the decision as to mounted or dismounted employment after thoroughly considering the factors of METT-TC. They also must consider the loss of mobility that results when an antiarmor weapon system is dismounted from its vehicle.

D-2. SELECTION OF FIRING POSITIONS

Indirect fires present the greatest danger to antiarmor squads. For this reason, covered and concealed locations are critical for an antiarmor squad's survival. Squads avoid firing positions that could be easily identified by an enemy map reconnaissance. The enemy normally fires artillery and mortar fires to support an attack based on a schedule. Enemy forces in an offense have limited ability to fire on targets of opportunity. Therefore, choosing firing positions carefully will help antiarmor squads avoid much of these indirect fires.

a. Squad leaders select firing positions that afford maximum protection yet allow the gunner to effectively engage the targets. Firing position selection begins when each section is assigned a mission, a sector of fire or a portion of an engagement area, and a general location. The section leader then designates a firing position for each of his two antiarmor squads.

b. Leaders select positions below ridgelines and crests, preferably on the sides of hills. Positions, along with the routes to them, should be as dry and as level as possible. Leaders should avoid choosing positions such as swampy areas, steep hillsides, and on or near prominent terrain features.

c. Leaders select firing positions during daylight and position antiarmor squads at night to reduce the chance of enemy detection. Leaders must not assume that darkness provides concealment for their firing positions. Through the use of night vision devices, enemy forces see almost as well in darkness as in daylight. Thermal imagery devices sense the heat emitted by vehicles and personnel. These devices provide the enemy with a capability to see through smoke, light foliage, and camouflage. Antiarmor squads continuously improve their positions

throughout mission preparation.

- d. Each antiarmor squad's firing position must provide the following advantages:
 - Cover to the front, flank, and overhead.
 - Concealment from ground and aerial observation.
 - Good observation and fields of fire into the assigned portion of an engagement area.
 - Covered and concealed routes to, and between, positions.
 - Mutual support between antiarmor squad positions and with other elements.

D-3. PRIMARY, ALTERNATE, SUPPLEMENTARY, AND SUBSEQUENT POSITIONS

Each antiarmor squad must have a primary firing position. Leaders may assign any number of alternate, supplementary, and subsequent positions as a result of their analysis of the factors of METT-TC.

a. **Primary Position.** The initial firing position from which an antiarmor squad covers an assigned sector of fire or portion of an engagement area along an enemy's most likely avenue of approach is referred to as the squad's primary position (Figure D-1) and is the best position for engaging enemy vehicles. The company commander or platoon leader usually designates the general location of this position.

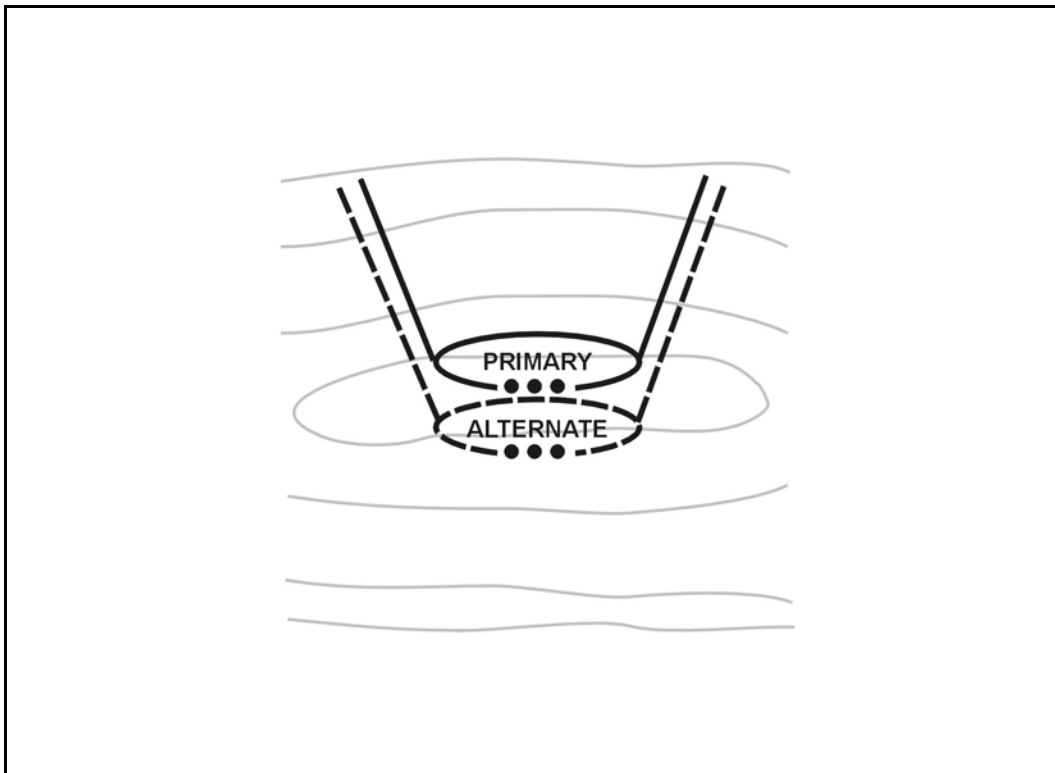

Figure D-1. Primary and alternate position.

b. **Alternate Position.** An antiarmor squad's alternate position (Figure D-1) must be able to cover the same enemy avenue of approach or sector of fire as from the primary

position. The company commander or platoon leader designates the locations of alternate positions to be used when primary positions become untenable or unsuitable for the assigned task. When squads have sufficient time and resources, they construct an alternate position to the same level of preparation as a primary position.

(1) As a guideline, an alternate position should be located 300 meters or more (METT-TC dependent) from the primary position to reduce the chance that indirect fire that suppresses the primary position also will affect the alternate position. Though terrain may not allow this much space, leaders should always consider this guideline when selecting alternate positions.

(2) If the antiarmor squad leader selects alternate positions, he should report the locations of each alternate position to the section leader and platoon leader.

c. **Supplementary Position.** The supplementary position (Figure D-2) allows the antiarmor squad to cover an enemy avenue of approach or sector of fire that is different from that covered by the primary or alternate positions. It usually is chosen to cover avenues of approach to the flank or rear of a unit. The antiarmor squad reconnoiters this position and prepares a range card. Leaders will typically base occupation of a supplementary position on specific enemy actions.

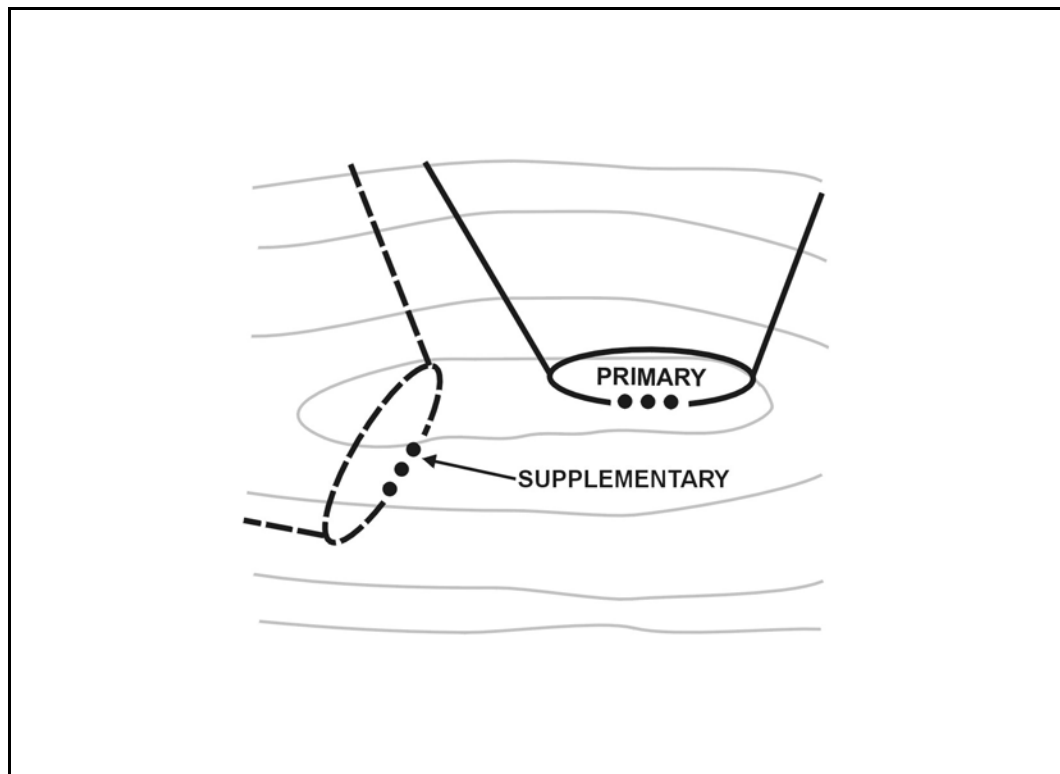

Figure D-2. Supplementary position.

d. **Subsequent Position.** The subsequent position (Figure D-3, page D-4) is a position that a unit expects to move to during the course of battle. A defending antiarmor unit may have numerous subsequent positions. These positions may also have primary, alternate, and supplementary positions associated with them.

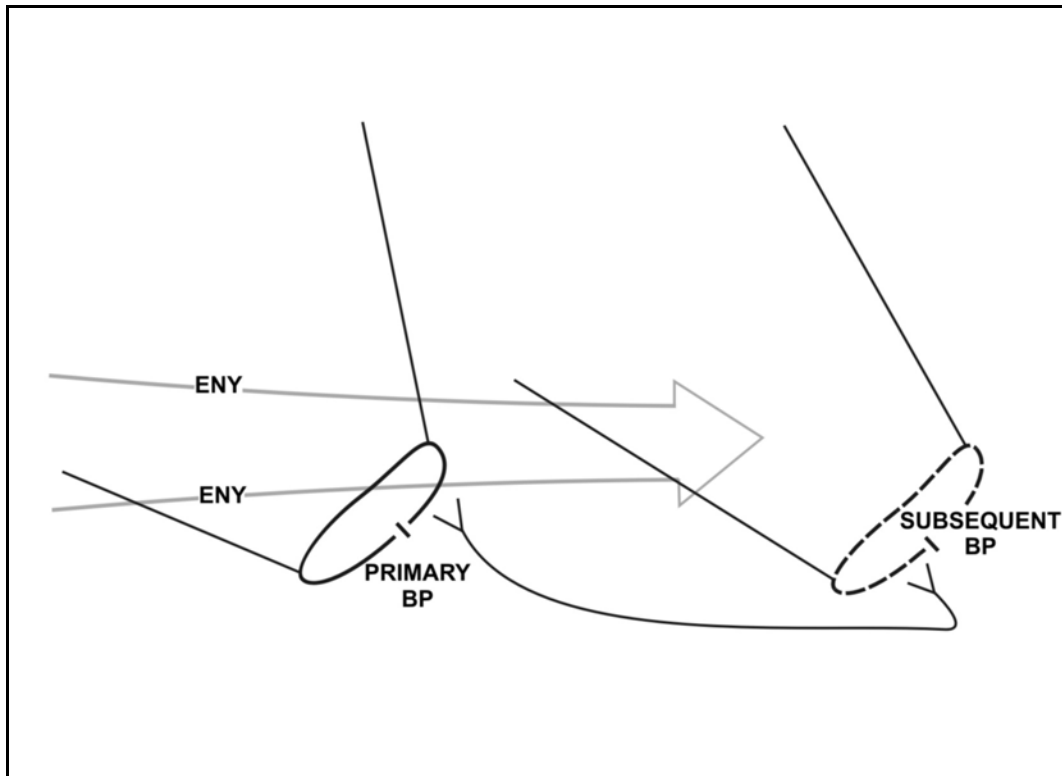

Figure D-3. Subsequent position.

D-4. FIRING POSITION PREPARATION.

The company commander or platoon leader will designate the level of preparation for each firing position based on the factors of METT-TC, with emphasis on the time available. There are three levels of preparation: reconnaissance, preparation, and occupation.

a. **Reconnaissance.** Leaders must reconnoiter the EA or AO and firing positions. They must get on the ground to physically inspect the terrain and determine its effects on antiarmor weapons employment and on enemy weapons employment. In the offense, this reconnaissance will typically occur through a detailed map reconnaissance. General positions with limited fire control measures must be identified during reconnaissance.

b. **Preparation.** The platoon or section begins preparing a firing position as soon as the leaders complete their reconnaissance. The leaders call the vehicles forward and guide them into position. They may consider having drivers back the vehicles into position so they can leave quickly without moving toward the enemy or using time to turn around. The unit removes or camouflages all signs that the enemy could detect (such as wheel tracks, windshield reflections). Antiarmor squads continue to improve the position until it is vacated. Preparation includes, but is not limited to--

- Marking the position.
- Emplacing fire control measures (as required).
- Digging the position.
- Identifying and digging ammunition caches.
- Preparing a range card.

- Emplacing protective obstacles.
- Camouflaging the position.

The antiarmor squad occupies the general position identified by the platoon leader or section leader and establishes security. Each antiarmor squad must be prepared to fight while it prepares the position. Maintaining security during preparation allows the antiarmor squad to react quickly if the enemy appears before the position has been completed.

(1) After selecting a firing position, the leaders mark the position with stakes and prepare a range card. This enables the squad or another squad to occupy the firing position and use the data from the range card for the position. They use three stakes to mark a mounted firing position (Figure D-4). One stake is placed in front of and centered on the vehicle. It should be long enough so that the driver can see it as he moves the vehicle into position. The other two stakes are placed parallel to the left side of the vehicle and lined up with the hub on the front and rear wheels. The stakes are placed close to the vehicle with enough clearance to allow the driver to move into the position without knocking the stakes down. The stakes are driven solidly into the ground. Engineer tape or luminous tape can be placed on the friendly side of the stakes to make it easier to see them during limited visibility.

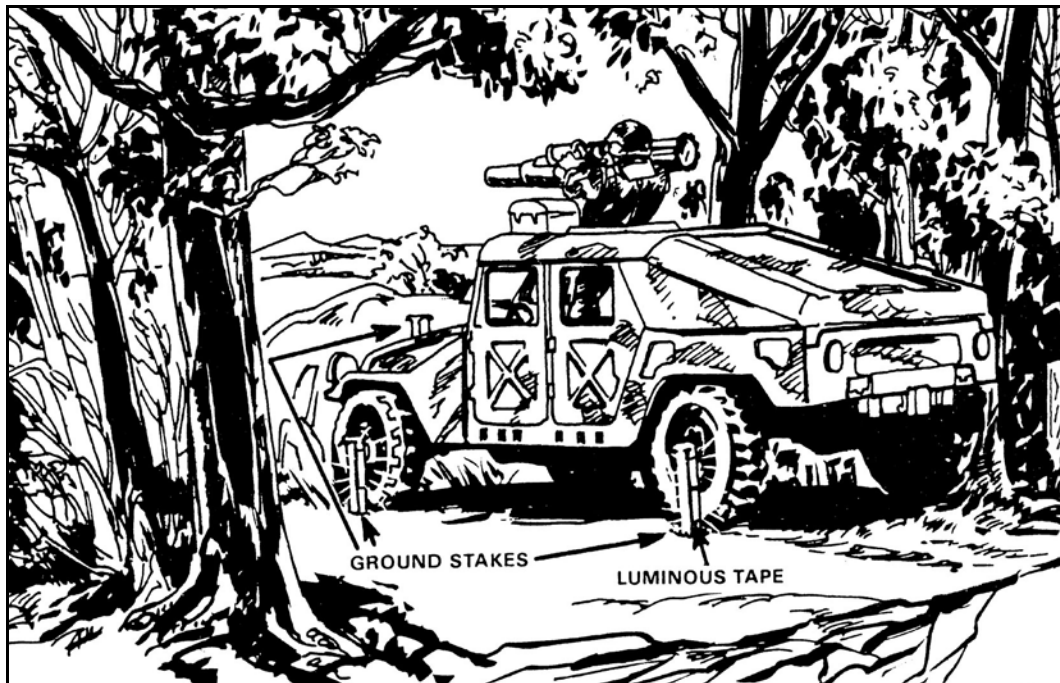

Figure D-4. Staking the position.

(2) Once the antiarmor squad has dug the position, it camouflages it. Squad members use sod, leaves, brush, grass, or any other natural material to do so. The items should not be taken from the immediate area of the position. Camouflage nets or other man-made materials also are used, but these work best if used with natural materials. The position should look as natural as possible.

c. **Occupation.** The company commander or platoon leader must establish triggers for occupation of the position.

(1) Vehicles approach the firing position from the rear using terrain-driving techniques

on a rehearsed route.

(2) To reoccupy a marked position, the driver aligns his vehicle on the front stake and moves forward slowly until the two stakes on the left of his vehicle are centered on the front and rear wheels.

(3) Antiarmor units must develop an SOP for occupying a firing position. The SOP must include the sequence of action and the priority of work. This ensures that all squad members know what is expected of them.

D-5. TYPES OF ANTIARMOR POSITIONS

Based on a thorough analysis of the factors of METT-TC, leaders select the appropriate type of antiarmor firing position for the situation.

a. **Mounted Position.** The mounted firing position is characterized by a hull-down posture. The vehicle is positioned behind either a natural or constructed cover with only the selected antiarmor system exposed. Leaders should seek a natural hull-down position (Figure D-5) whenever it is available. During offensive operations, natural hull-down positions are identified by a detailed map reconnaissance. When a natural hull-down position is not available, the unit obtains engineer assistance to excavate hull-down positions (Figure D-6). When hide positions are used, the primary firing positions should be hull-down positions. Leaders should select or construct hull-down positions so that the vehicle moves quickly into complete defilade. Routes into and out of hull-down positions should offer sufficient cover and concealment (Figure D-7, page D-8).

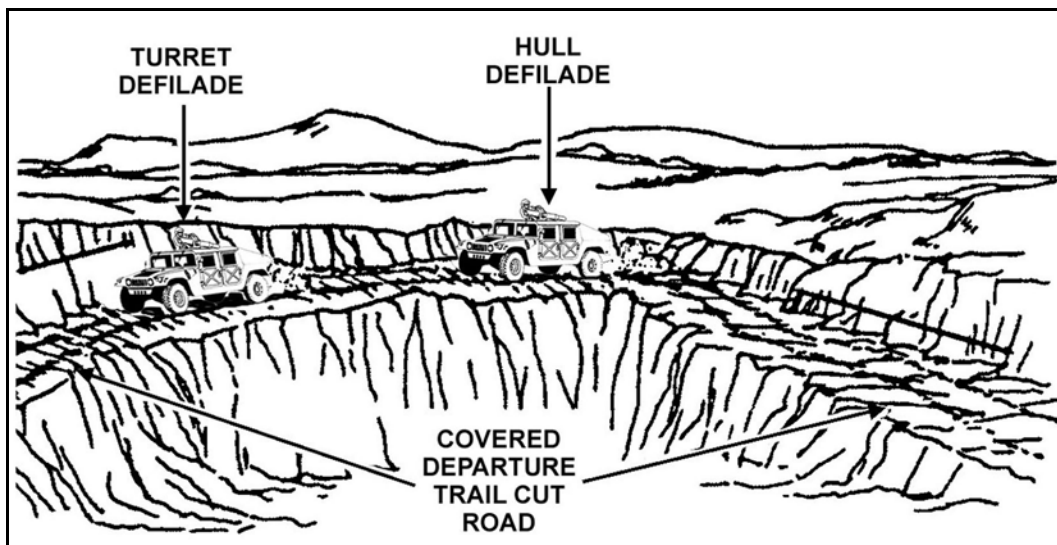

Figure D-5. Natural hull-down position.

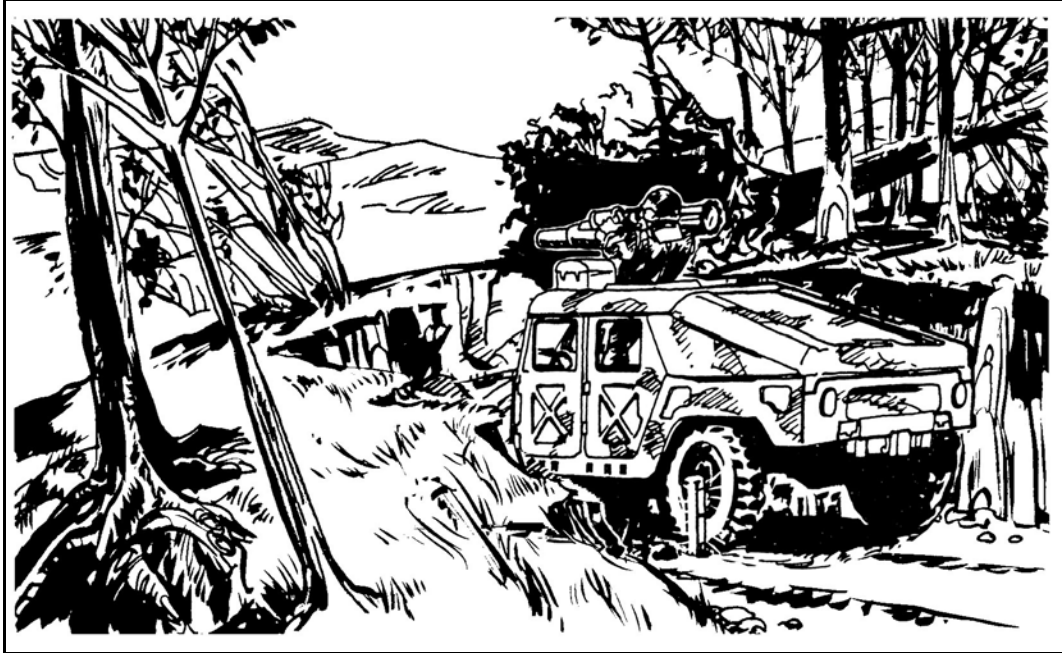

Figure D-6. Excavated hull-down position

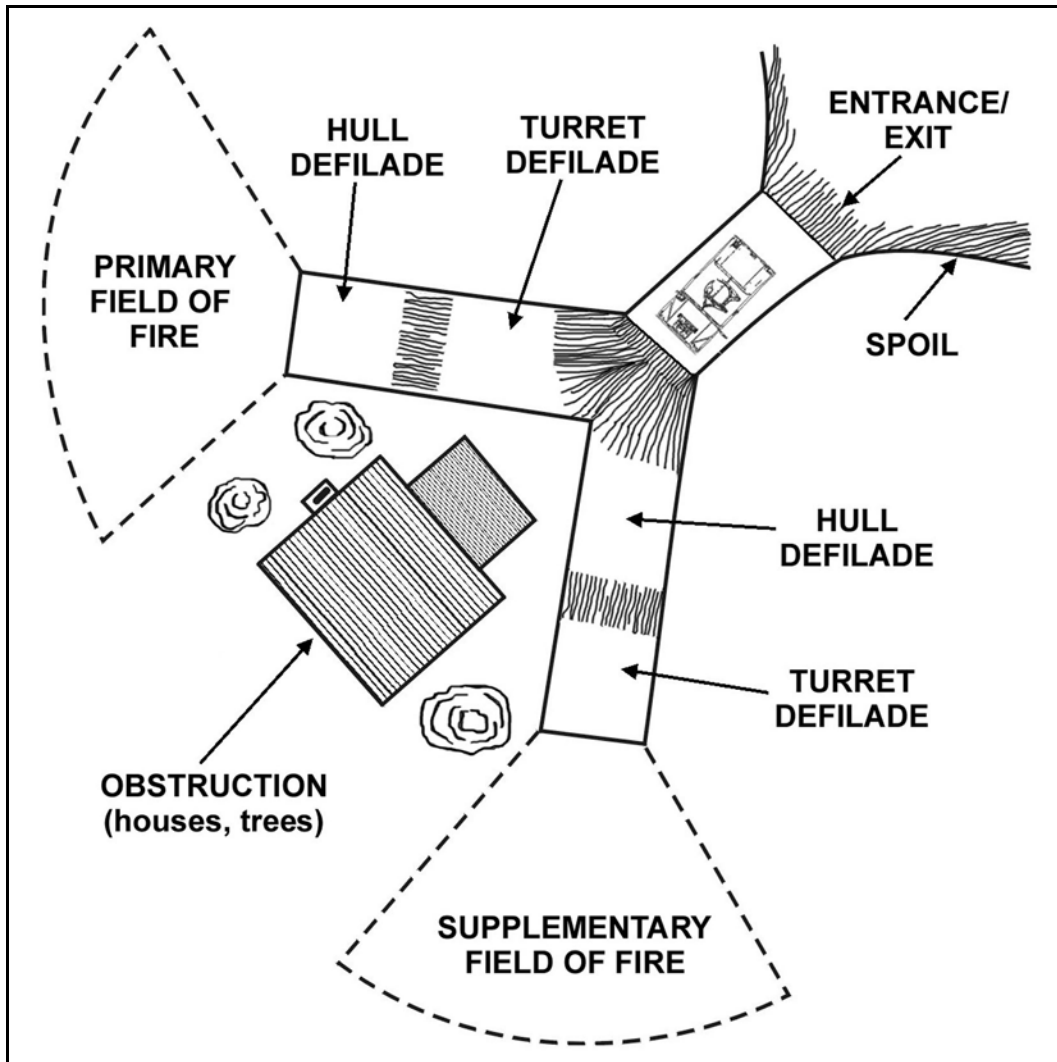

Figure D-7. Hide position to hull-down position

b. **Dismounted Position.** The dismounted position must have cover and concealment to protect squads from direct and indirect fires. Overhead cover must be camouflaged. Overhead cover must allow room to effectively operate the selected weapon system (for example, able to raise the bridge clamp and insert the missile's indexing lugs into the indexing slots on the launch tube). Individual weapons must be positioned for effective self-defense.

(1) The squad keeps the selected weapon system mounted in the vehicle while it constructs a dismounted position and the gunner prepares a range card. The tripod outlines the dismounted position (Figure D-8). Once the position is complete, the squad emplaces the selected weapon system in the position and camouflages the position.

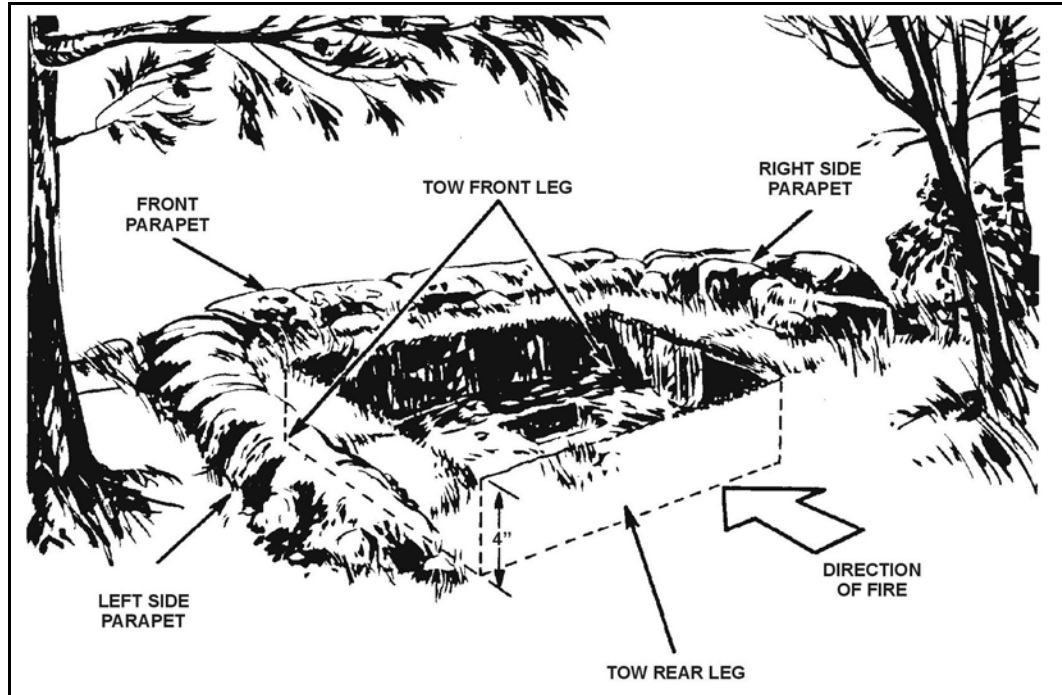

Figure D-8. Outline of dismounted position

(2) The squad constructs parapets to the front and flanks that are at least 18 inches thick (the length of two collapsed entrenching tools) for protection from small-arms fire and mortar and artillery fragments. For TOW employment, the squad ensures a 9-inch clearance (the length of one collapsed entrenching tool) between the bottom of the launcher tube and the parapet. The squad digs a hole between the tripod legs for the missile guidance set (Figure D-9, page D-10). The squad digs the position no more than 24 inches deep (the length of a fully extended entrenching tool) to ensure adequate LOS clearance on flat terrain out to ranges of between 500 and 900 meters

(3) The squad digs additional positions on each side and to the rear of the antiarmor position. The squad also adds overhead cover for personnel and for the ammunition to each of these positions (Figure D-9, page D-10).

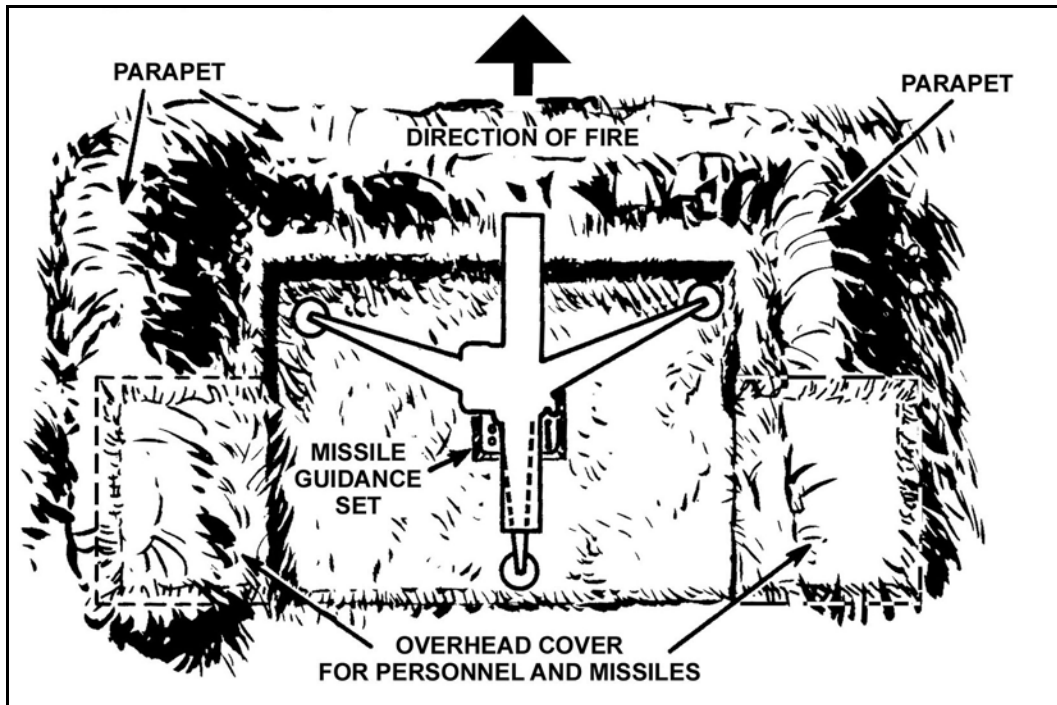

Figure D-9. Overhead cover and missile guidance set position.

(4) The squad reinforces the walls of the position with sandbags if the soil or water table does not support a dug-in position. (See FM 5-103 for construction and water drainage methods.)

(5) The squad builds the overhead cover to conform to the terrain, making the position more difficult to detect. For adequate protection from mortar or artillery fragments, the squad uses logs four to six inches in diameter and covers them with 12 to 14 inches of soil. The total protection should equal 18 inches (the length of two collapsed entrenching tools).

(6) The squad places a layer of waterproof material, such as packing material or a poncho, over the logs before adding the dirt to help keep the position dry. If sandbags are used, the squad covers them with waterproof material. Wet sandbags are heavy and can cause a cave-in.

c. **Anitarmor Ambush Position.** The squad constructs a simple dismounted position to conduct an antiarmor ambush. This position should be large enough to conceal the antiarmor system and the squad until the ambush is completed. The position requires no overhead cover. In fact, the antiarmor squad uses existing terrain features for this purpose. In choosing this position, the squad leader considers whether his squad can survive returned fire from the ambushed enemy element. The weight of the selected antiarmor system and the distance it must travel are important planning considerations because they prevent the squad from quickly withdrawing from the ambush site.

d. **Urban Terrain Position.** The squad leader considers the same crew survival question that he would for an antiarmor ambush position. (See FM 5-103 and FM 90-10-1 for more information.) Urban terrain affords the squad more cover and concealment. However, urban terrain does present certain firing limitations. For example, the TOW should be fired from a building only when the following conditions exist:

- The building is sturdy.
- The ceiling is at least 2 meters (7 feet) high.
- The room is at least 5 meters by 8 meters (17 feet by 24 feet) or larger.
- There are 2 square meters (20 square feet) of ventilation to the rear of the system (an open door 2 meters by 1 meter [7 feet by 3 feet] provides that much ventilation).
- Glass is removed from all windows and doors, the floor is swept, and any furniture and other objects that could be blown around are removed from the room.
- Squad members in the room are wearing hearing protection and ballistic eye protection and are positioned forward of the rear end of the launch tube.

D-6. GROUND CLEARANCE FOR TOW MISSILE EMPLOYMENT

Two clearance requirements are observed to ensure that a TOW missile will not hit the ground before reaching a target.

a. The muzzle clearance around the end of the launch tube should be at least 9 inches. This clearance ensures the wings and control surfaces can freely extend after the missile clears the launch tubes. If the wings are damaged or if they catch on an object, the missile may fly erratically or fall to the ground.

b. The missile's launch motor pushes the missile out of the tube. The missile's flight motor then accelerates the missile for 500 to 900 meters to obtain its flight speed. Somewhere between these distances, the missile's trajectory drops. A missile also does not precisely follow a gunner's LOS to the target. To compensate for this and to prevent the missile from hitting the ground or an obstruction, the gunner allows 30 inches of clearance along the LOS between the launcher and the ground (Figure D-10). If the LOS clearance is less than 30 inches, the probability of the missile hitting the ground or an obstruction is increased. Table D-1, page D-12, highlights the probability of survival for the TOW missile.

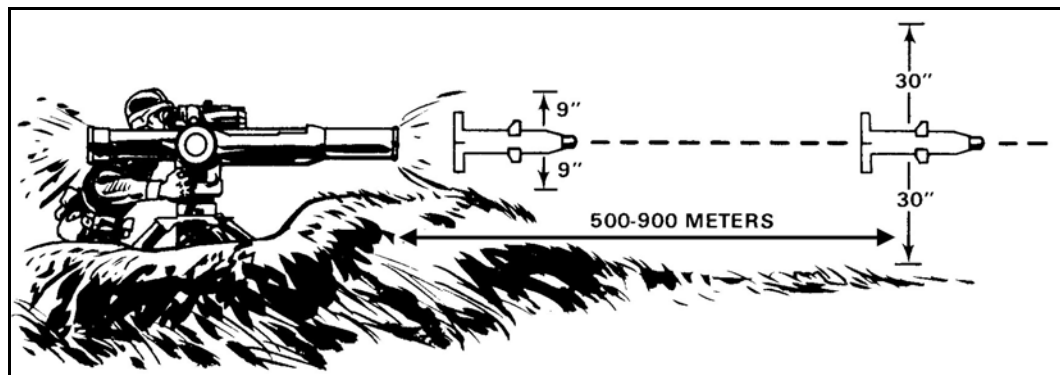

Figure D-10. Ground clearance

METERS		HEIGHT OF LINE OF SIGHT ABOVE THE GROUND		
		18 INCHES	20 INCHES	30 INCHES
RANGE TO TARGET	200	.98	.98	1.0
	300	.95	.96	1.0
	400	.91	.91	.98
	500	.86	.91	.98
1,000 to 3000/3,750		.56	.61	.93

Table D-1. Probability of survival for the TOW.

D-7. FIGHTING AND SURVIVABILITY POSITIONS

The commander's defensive plan will normally require building fighting positions. Fighting positions protect soldiers by providing cover from direct and indirect fires and by providing concealment through positioning and proper camouflage.

a. **Standard Designs.** When expecting an immediate enemy attack, infantrymen dig hasty fighting positions. As time becomes available these are improved, enlarged, and strengthened, a process that continues as long as the unit occupies a defensive position. Because the battlefield conditions confronting infantrymen are never standard, there is no single standard fighting position design that fits all tactical situations.

(1) Sometimes soldiers must construct fighting positions using only the basic tools and materials they can carry or find in the local area, such as entrenching tools, sandbags, and locally cut timber. At other times significant amounts of Class IV construction materials and heavier digging tools may be available.

(2) At times the terrain will accommodate the construction of a position with overhead cover that protects soldiers from indirect fire fragmentation while allowing them to return fire. Sometimes, especially on open terrain, this is not possible and the entire position must be built below ground level. Although this type position offers the occupants' excellent protection and concealment, it limits their ability to return fire from within a protected area.

(3) Infantry fighting positions are normally constructed to hold one, two, or three soldiers. There are special designs adapted for use by machine gun and antitank missile teams. Fighting vehicles in hull- and turret-defilade positions should be integrated into the unit defense, although not necessarily adjacent to infantry positions.

(4) Regardless of the position design, the type of construction materials, the tools available, or the terrain, all fighting positions must incorporate sound engineering construction principles. Unless it is constructed properly, a fighting position can easily collapse and crush or bury the soldiers within.

NOTE: FM 5-103 and FM 5-34 provide excellent information on these principles. Additionally, GTA 05-08-001 and GTA 07-06-001 contain detailed information in easy-to-use formats.

(5) In constructing fighting positions, soldiers should--

- Dig the positions no deeper than armpit deep.
- Fill sandbags no more than 75 percent full.
- Use revetments to support excavations in sandy soil.
- Check stabilization of wall bases.
- Inspect and test the position daily, after heavy rain, and after receiving fire.

- Maintain, repair, and improve positions constantly.
- Keep all vehicles at least five meters away from the position.

b. **Priority of Work.** Leaders must ensure that soldiers prepare for the defense quickly and efficiently. Work must be done in priority to accomplish the most work in the least amount of time while maintaining security and the ability to respond to enemy action.

Priorities of work include--

- Emplace OPS and conduct local security patrols.
- Position and assign sectors of fire for TOWs and machine gun teams (platoon leader).
- Position and assign sectors of fire for SAW gunners, grenadiers, and then riflemen (squad leaders).
- Clear fields of fire and prepare range cards and sector sketch.
- Dig fighting positions (stage 1). See Paragraph D-7c(2)(a) below.
- Establish communications with the company team and adjacent units.
- Emplace antitank and Claymore mines, then wire and other obstacles.
- Improve primary fighting positions and add overhead cover (stage 2). See Paragraph D-7c(2)(b) below.
- Prepare supplementary and then alternate positions.
- Distribute and stockpile ammunition, food, and water.

Several of these actions may be accomplished at the same time. Leaders must constantly supervise the preparation of fighting positions, both for tactical usefulness and proper construction.

c. **Principles.** Three basic principles govern construction of fighting positions: site position to best engage the enemy, prepare by stages, and leaders inspect all positions.

(1) **Site Positions to Best Engage the Enemy.** The most important aspect of a fighting position is that it must be tactically well positioned. Leaders must be able to look at the terrain and quickly identify the best location for fighting positions.

- Soldiers must be able to engage the enemy within their assigned sectors of fire.
- They should be able to fire out to the maximum effective range of their weapons with maximum grazing fire and minimal dead space.
- Grenadiers should be placed in positions to cover dead space.
- Leaders must ensure fighting positions provide mutually supporting, interlocking fires. This allows them to cover the platoon's sector from multiple positions and to provide a basis for final protective fires.
- When possible, site positions behind natural cover and in easily camouflaged locations. The enemy must not be able to identify the position until it is too late and he has been effectively engaged.

(2) **Prepare Positions by Stages.** Leaders must ensure their soldiers understand when and how to prepare fighting positions based on the situation. Soldiers prepare hasty fighting positions every time the platoon makes an extended halt. Half of the platoon digs in while the other half maintains security. Soldiers prepare positions in stages and a leader inspects the position at each stage before they move to the next stage. (See the following example.)

(a) **STAGE 1:** The platoon leader checks fields of fire from the prone position. The soldiers--

- Emplace sector stakes (Figure D-11).
- Stake the primary sector.
- Position grazing fire log or sandbag between the sector stakes.
- Place the aiming stake(s), if required, to allow limited visibility engagement of a specific target.
- Scoop out elbow holes.
- Trace the outline of the position on the ground.
- Clear fields of fire for both primary and secondary sectors.
- The leader inspects the position.

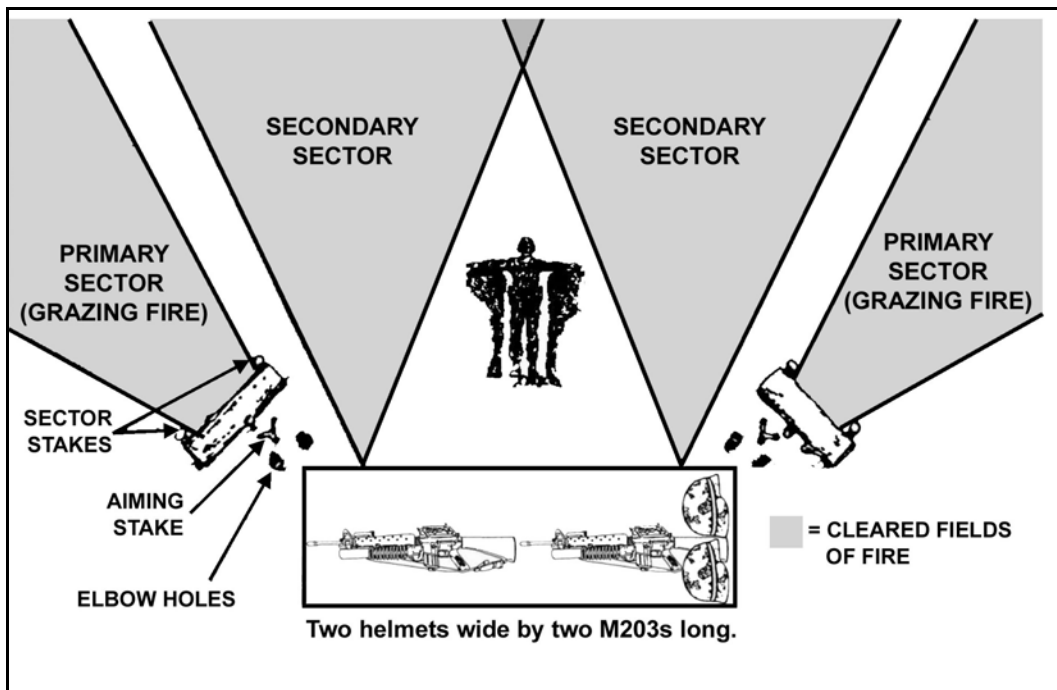

Figure D-11. Stage 1, Preparation of a fighting position.

- (b) **STAGE 2:** Soldiers prepare retaining walls for the parapets. They ensure that--
- There is a minimum distance (equal to the width of one helmet) from the edge of the hole to the beginning of the front, flank, and rear cover (Figure D-12).
 - The front cover is two to three sandbags (or logs) high. For a two-soldier position, it is about two M203 lengths long.
 - The flank cover is the same height, but only one M203 rifle long.
 - The rear cover is one sandbag high and one M203 long.
 - If logs are used, they must be held firmly in place with strong stakes.
 - The leader inspects the retaining wall.

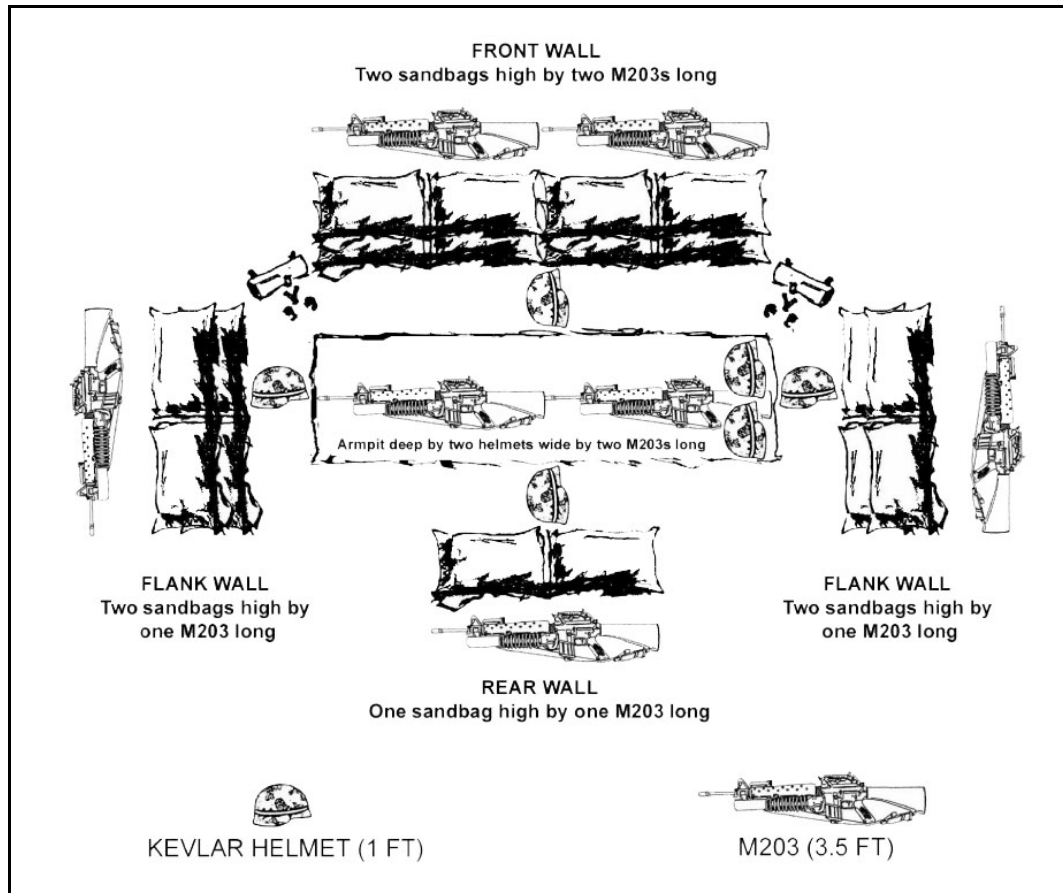

Figure D-12. Stage 2, Preparation of a fighting position.

(c) **STAGE 3:** Soldiers dig the position and throw dirt forward of the parapet retaining walls and pack it down hard (Figure D-13, page D-16). They--

- Dig the position armpit deep (tallest soldier).
- Fill the parapets in order of front, flanks, and rear.
- Camouflage the parapets and the entire position.
- Dig grenade sumps and slope the floor toward them.
- Dig storage areas for the two rucksacks into the rear wall if needed.
- Ensure the leader inspects the work.

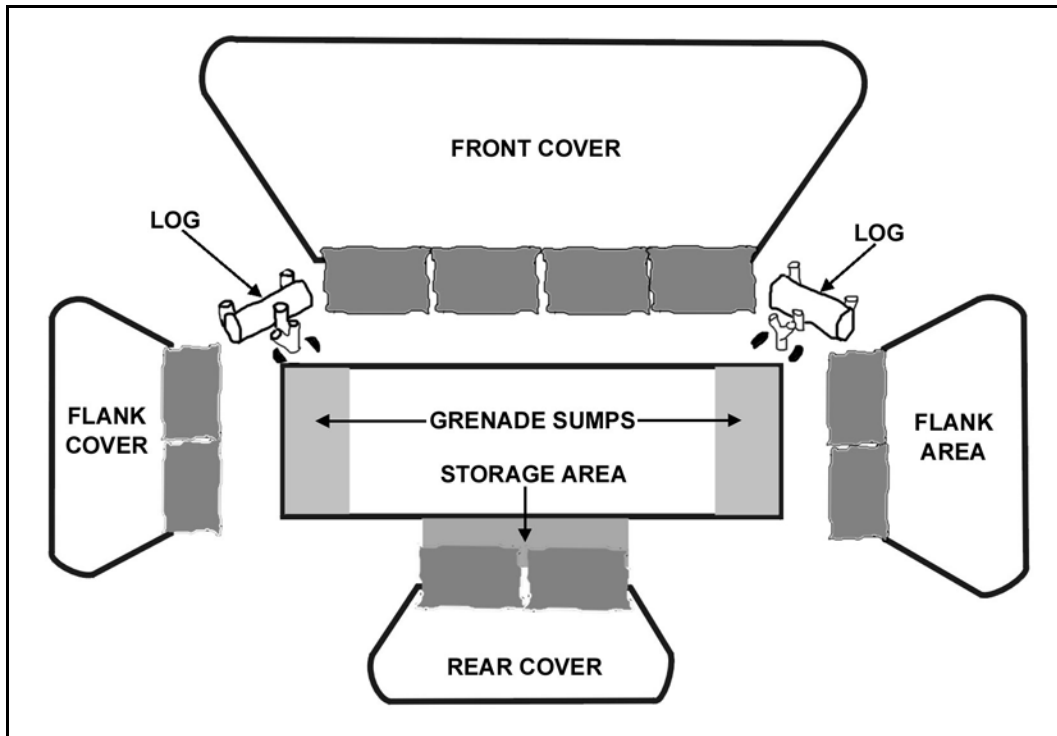

Figure D-13. Stage 3, Preparation of a fighting position.

(d) **STAGE 4:** Soldiers prepare the overhead cover (Figure D-14). They--

- Always provide solid support for overhead cover. Build the support using 4- to 6-inch logs on top of each other running the full length of the front and rear cover.
- Place five or six logs 4 to 6 inches in diameter and two M203s long over the center of the position, resting them on the overhead cover support, not the sandbags.
- Place waterproofing (plastic bags, ponchos) on top of these logs.
- Put a minimum of 18 inches of packed dirt or sandbags on top of the logs.
- Camouflage the overhead cover and the bottom of the position.
- Ensure the leader inspects the position.

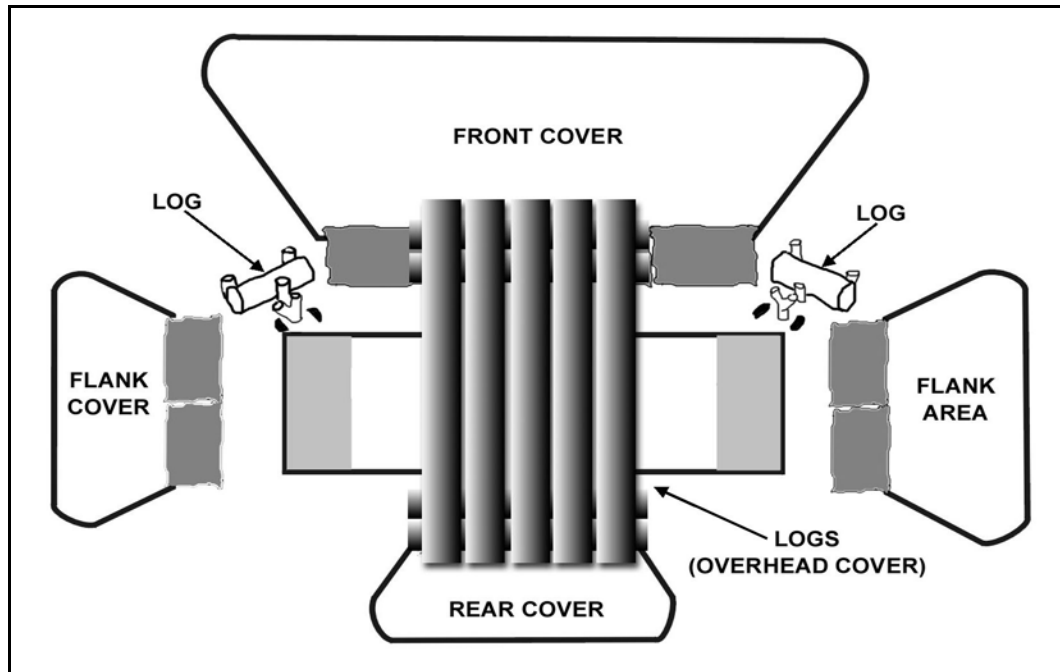

Figure D-14. Stage 4, Preparation of a fighting position.

(3) **Leaders Inspect All Positions.** Leaders must ensure their soldiers build fighting positions that are both effective and safe. An improperly sited position cannot be used and an improperly constructed one is a danger to its occupants.

D-8. M2 (CALIBER .50) AND MK 19 MACHINE GUN FIRING POSITIONS

Mounted positions for the MK19 and M2 are identical to those of the TOW. The use of hull-defilade firing platforms and full-defilade hide positions are critical. The following paragraphs provide information peculiar to the construction of MK19 and M2 dismounted firing positions.

a. **M2 Position.** The primary sector of fire is usually to the oblique so the gun can fire across the platoon's front. The tripod is used on the side covering the primary sector of fire. The bipod legs are used on the side covering the secondary sector of fire. When changing from primary to secondary sectors, the gunner moves only the machine gun. Occasionally a sector of fire that allows firing directly to the front is assigned, but this can reduce the frontal cover for the crew when firing to the oblique (Figure D-15, page D-18).

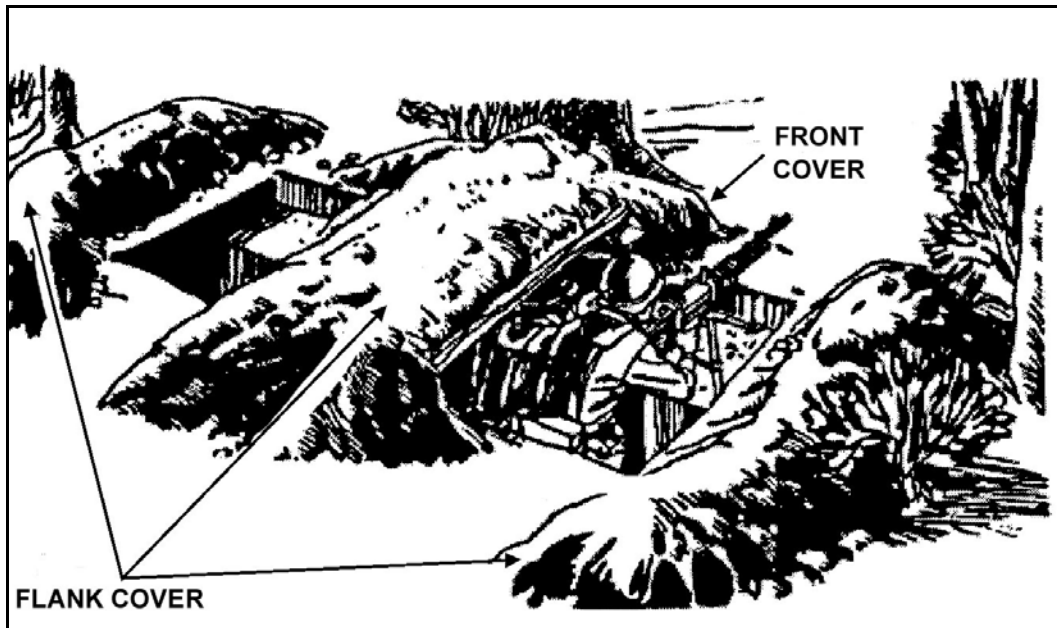

Figure D-15. Machine gun position.

(1) After the platoon leader positions the machine gun, he marks the position of the tripod legs and the limits of the sectors of fire. The crew then traces the outline of the hole and the frontal cover (if it must be improved).

(2) The crew digs firing platforms first to lessen their exposure in case they must fire before they complete the position. The platforms must not be so low that the gun cannot be traversed across its entire sector of fire, reducing the profile of the gunner when firing and reducing the frontal cover height.

(3) After digging the firing platforms, the crew digs the hole. They first place the dirt where frontal cover is needed, digging the hole deep enough to protect them and still allow the gunner to fire with comfort (usually about armpit deep). When the frontal cover is high enough and thick enough, the crew uses the rest of the dirt to build flank and rear cover. Trench-shaped grenade sumps are dug at various points so either soldier can kick a grenade into one if needed. Overhead cover for a machine gun position is built the same as for a two-soldier position.

NOTE: In some positions, a machine gun might not have a secondary sector of fire. In this case, dig only half the position.

(4) When there is a three-soldier crew for a machine gun, the ammunition bearer digs a one-soldier fighting position to the flank that is connected to the gun position by a crawl trench. From his position, the ammunition bearer can see and fire to the front and to the oblique. The ammunition bearer usually is on the same side as the FPL or PDF. This allows him to see and fire his rifle into the machine gun's secondary sector and to see the gunner and assistant gunner.

b. **MK 19.** The MK19 position is constructed similar to the machine gun position (Figure D-15) and is constructed after the weapon is positioned so that it is oriented on the

center of the assigned sector of fire. The tripod legs are outlined to ensure the firing platform is properly constructed. The position is dug in an L-shape around the firing position. It should be approximately chest-deep (tallest soldier) and wide enough to allow the squad to load, operate, and place fire on the assigned sector of fire. In constructing the over head protection for the position, allowance must be made for elevation of the gun during firing.

c. Three-Soldier Fighting Position. A three-soldier position has several advantages. A leader can be in each position, making command and control easier. It supports continuous security operations better than other positions. One soldier can provide security; one can do priority work; and one can rest, eat, or perform maintenance. This allows the priority of work to be completed more quickly than in a one- or two-soldier position. This position allows the platoon to maintain combat power and security without shifting personnel or leaving positions unmanned. It provides 360-degree observation and fire, and it is more difficult for the enemy to destroy because he must kill or suppress three soldiers.

(1) When using three-soldier positions, the leader must consider several things. Either the distance between positions must be increased or the size of the squad's sector must be reduced. The choice depends mainly on visibility and fields of fire. Because the squad leader is in a fighting position that will most likely be engaged during the battle, he cannot exert personal control over the other two positions. The squad leader controls the battle by--

- Clearly communicating his plans and intent to his squad to include control measures and fire plans.
- Using prearranged signals like flares, whistles, or tracers.
- Positioning key weapons in his fighting position.
- Placing his fighting position so it covers key or decisive terrain.
- Placing his fighting position where his team might be able to act as a reserve.

(2) The three-soldier emplacement is a T-position. This basic design can be changed by adding or deleting berms, changing the orientation of the T, or shifting the position of the third soldier to form an L instead of a T (Figure D-16, page D-20). The layout of the position can be oriented to fire on expected enemy avenues of approach from any direction. Berms must not block observation or fire into assigned primary or alternate sectors. Care must be taken to properly support the overhead cover.

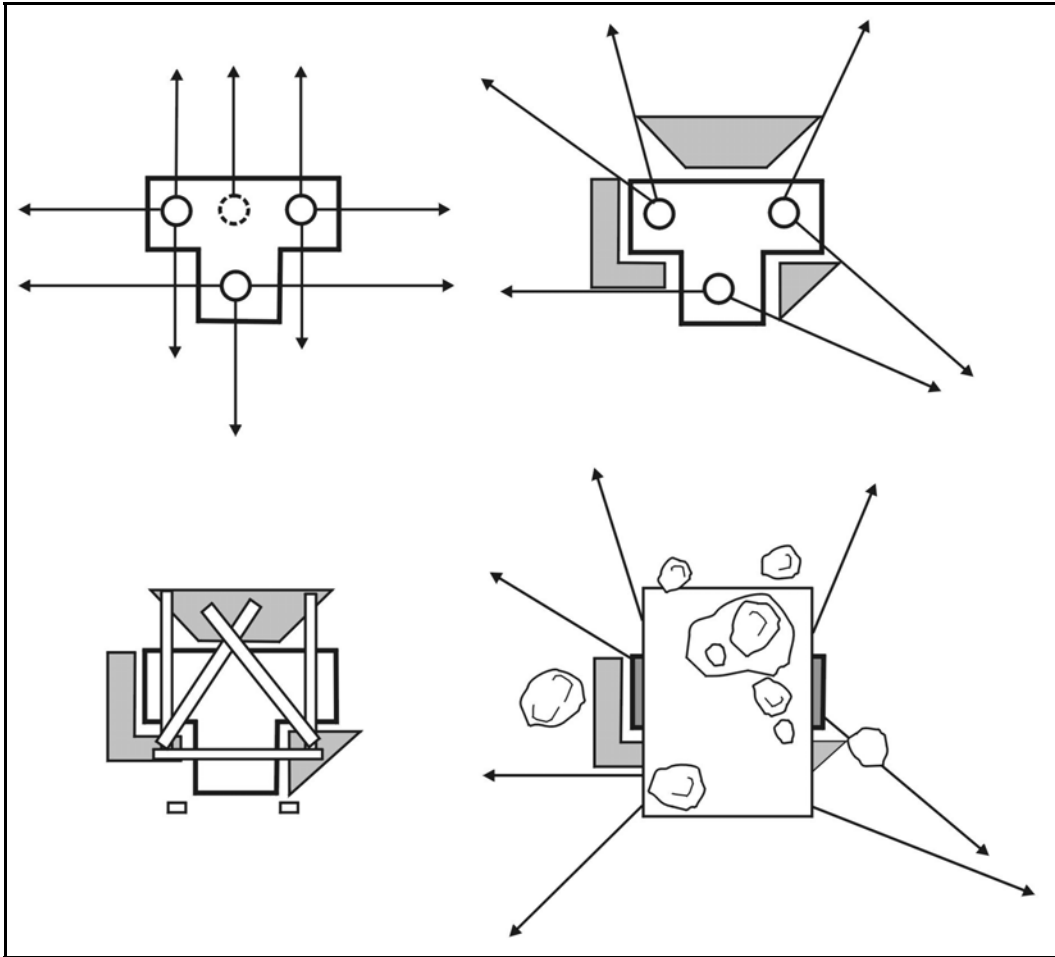

Figure D-16. Three-soldier T-position.

D-9. RANGE CARD

A range card is a sketch or diagram of the terrain that a weapon must cover by direct fire. It shows planned target areas and terrain features, each of which is plotted relative to that weapon's firing position. The information on a range card is used to plan and control fire, to rapidly detect and engage targets, and to orient replacement personnel and units. Instructions for completing a range card are found in FM 23-34.

D-10. SECTOR SKETCH

Individual soldiers and gunners prepare range cards. Squad leaders (or vehicle commanders), section leaders, platoon leaders, and company commanders prepare sector sketches for their echelon. Accurate and detailed sketches aid in direct fire planning and in direct fire control and distribution.

a. **Platoon Sector Sketch.** The antiarmor platoon leader reviews his squads' and sections' sector sketches and ensures that the sketches are accurate. If he finds any gaps of coverage or flaws, the platoon leader adjusts weapons locations or sectors. Once the platoon leader approves the squad and section sector sketches, he prepares a consolidated report for the company commander and incorporates this into a consolidated platoon sector sketch. The platoon leader or platoon sergeant prepares the platoon sector sketch. The sector sketch may

be on acetate taped to a map or it can be a hand drawn sketch.

b. **Company Sector Sketch.** The company commander incorporates all of the platoon sector sketches and any separate key weapon system range cards into a consolidated company sector sketch. If he finds any gaps of coverage or flaws, he immediately corrects the deficiency by repositioning units or key weapon systems or by covering gaps with observation, obstacles, and indirect fires.

NOTE: FBCB2-equipped ICVs within the SBCT antiarmor company provide leaders with a more accurate means of recording and sharing sector sketch and range card data. If the company commander finds any gaps or other flaws, he adjusts weapons locations or the graphic control measures within the FBCB2 system. He can then quickly disseminate changes to all of his subordinates and to his higher headquarters.

APPENDIX E

TOW EMPLOYMENT IN RESTRICTIVE TERRAIN

The infantry fights best in restrictive terrain. However, the TOW missile system is optimized in unrestricted terrain. A thorough METT-TC analysis is necessary to choose the best employment option. Although the M2 or MK19 is of better use in restrictive terrain, antiarmor leaders must know when and how to effectively employ the TOW to support infantry in the same terrain.

E-1. DEFINITION

Restrictive terrain is defined as terrain that hinders movement to some degree. Little effort is needed to enhance mobility, but units may need to detour frequently. Units may have difficulty maintaining optimum speed or combat formation. Antiarmor leaders must recognize TOW system limitations and take advantage of the TOW system's capabilities in restrictive terrain. The types of terrain described below are examples of the types of restrictive terrain in which infantry forces operate. Often the categories blend together (for example, forests and steep hills).

a. **Forests and Jungles.** The degree and type of vegetation affects mounted movement, altering formations and speeds. Typically, armored vehicles will take advantage of roads or trails to move through these areas as quickly as possible. The ability to mass antiarmor fires on a slowed, contained enemy armored force may outweigh the degraded effectiveness of wire-guided missiles in this environment.

(1) **European-Model Forests.** These forests are well tended, free of underbrush or secondary growth, and often hilly. Unopposed armored forces can traverse these forests rapidly because of a large number of good trails. If armored vehicles are forced off the trails, the thickness and spacing of trees and the degree of slope determine how freely they can maneuver. The lack of undergrowth often allows visibility to several hundred meters.

(2) **Cut-Over or Primeval Forests and Jungles.** These forests have thick patches of vegetation and poor trail networks. Armored vehicles can travel through these forests if the ground is dry and not too steep, but such "jungle-busting" is slow and visibility and engagement ranges are short--often measured in the tens of meters. TOW employment is seriously degraded unless fire lanes are cut through the underbrush.

b. **Hills and Mountain Ranges.** The degree of slope and vegetation affect the mounted movement, altering formations and speeds.

(1) Forested hills usually force armored vehicles to move on trails, which canalizes mounted movement. This restriction allows carefully positioned TOW systems to engage enemy vehicles unable to maneuver out of an engagement area. However, because tree growth and underbrush restrict visibility and engagement ranges, antiarmor leaders carefully place the TOW systems for as maximum a range as possible.

(2) Bare hills and mountains, where steep terrain and lack of roads again canalize maneuver, often allow engagement out to maximum TOW ranges. However, if an antiarmor unit emplaces TOW systems in obvious positions, a mounted enemy can suppress them with direct and indirect fires. To avoid obvious positions, an antiarmor unit may emplace the TOW systems in locations that sacrifice standoff. This increases their protection from

preplanned enemy suppressive fires (direct and indirect) and allows them to gain surprise.

c. **Swamps and Wetlands.** Swamps stop mounted movement except on any hard-surfaced, elevated roads that pass through them. Flood plains and moors can support lightly armored vehicles, but this type of terrain is often trafficable only during dry periods. In northern Europe, terrain broken by drainage ditches and dikes is common; this type of terrain prevents armored vehicles from moving off roads. Clear weather and good visibility provide the antiarmor unit with better observation, resulting in TOW engagements of 2000 to 3750 meters. However, better visibility also aids the enemy in suppressing obvious TOW system firing positions.

d. **Urban Areas and Villages.** The world is becoming increasingly urbanized, and antiarmor units will likely find themselves employed during urban operations. This environment obviously affects TOW system employment. See Chapter 6, Urban Operations, for more information.

E-2. MANEUVER

Light infantry forces normally are employed on restrictive terrain that makes TOW employment more challenging. The TOW must be moved and positioned on terrain that supports the infantry, but it can be positioned apart from infantry positions. The antiarmor company or platoon can be moved on a separate axis of advance with task-organized infantry to provide security. Timing of the attack is critical. This is complicated because the main attack force (infantry) usually moves from the attack position to the objective on foot while the antiarmor unit usually moves by vehicle to its supporting position.

E-3. PROTECTION

In restrictive terrain, the antiarmor unit requires protection from close assault since it has limited, or no, armor protection and limited self-defense capabilities. Only after conducting a detailed analysis of the factors of METT-TC does the commander (or platoon leader) decide how to move the antiarmor unit. Options include--

- Attaching an antiarmor platoon to an infantry company.
- Attaching an infantry platoon to an antiarmor company.
- Attaching an infantry squad to an antiarmor platoon.
- Moving antiarmor unit's vehicles within the battalion formation.

E-4 GUIDELINES FOR TOW EMPLOYMENT

The basics of TOW employment outlined in Chapters 4 through 8 and direct fire planning and control described in Appendix C still apply when antiarmor units operate on restrictive terrain. However, commanders and leaders must look at these basics from a different perspective; certain principles may be more important than others, depending on the situation. Leaders can best employ the TOW missile in ambush scenarios where antiarmor units fire from unobtrusive positions to surprise the enemy and where TOW, infantry fires, mines, and indirect fires are closely coordinated. Finally, commanders must realize that employing the TOW in restrictive terrain is less than ideal, and they should do so only if the results of a detailed METT-TC analysis dictate it. The seven principles of TOW employment have been modified for consideration in restrictive terrain.

a. **Mutual Support.** Mutual support is vital when terrain inhibits the engagement range.

Instead of massing the TOW missile fires from the antiarmor company into an engagement area, leaders may have to mass fires with other infantry weapons systems (M2, MK19, Javelin, and AT4) and indirect fires.

b. **Security.** Shorter engagement ranges and ample concealment make antiarmor squads employing TOWs more vulnerable to dismounted enemy infantry. Therefore, the antiarmor unit should be positioned so that the infantry can protect it. If the infantry is not available, the antiarmor unit must protect itself by task-organizing the unit with some soldiers operating the TOW systems and other soldiers providing security with small arms or with M2 or MK19.

c. **Flank Shots.** The feasibility of flank shots often determines whether TOW systems should be employed, especially in restrictive terrain. Flank shots provide the largest view of the target and come from an unexpected direction. Enemy armored vehicles are better protected on the frontal slope; crew orientation is primarily to the front; and it is difficult to traverse a turret in most restrictive terrain. An enemy tank gunner or commander will fire his main gun or coaxial machine gun as a reaction to the flash of a TOW missile launch. The TOW gunner could lose focus on, and control of, the missile after seeing the enemy return fire. Leaders should strive for flank shots in restrictive terrain.

d. **Volley Fire.** Volley fire (also referred to as simultaneous fire) is used to rapidly mass the effects of fires or to gain immediate fires superiority over an enemy. It is also used to negate a low probability of hit given the terrain and expected engagement ranges. Antiarmor units need not volley fire TOW missiles only. Other weapon systems may be employed to complement the TOW to gain immediate fire superiority.

e. **Cover and Concealment.** Cover and concealment are especially important for TOW firing positions in restrictive terrain. Although antiarmor units try to fight from prepared positions, engineers may not be available to modify the terrain. Therefore, antiarmor units must often employ TOW missiles from hasty positions, mounted or dismounted. In restrictive terrain, antiarmor units use the existing terrain for cover and concealment.

f. **Employment in Depth.** Restrictive terrain limits TOW employment in depth for antiarmor. Depth in restricted terrain is achieved by focusing on where (or how) to destroy the enemy, not where to locate the system. One method is to emplace TOW systems so they each can fire into an engagement area from different locations (rear and flanks) at the same time. Strict direct fire control measures must be implemented to reduce the risk of fratricide (see Appendix C, Direct Fire Planning and Control). Another method to achieve depth is to designate different weapons systems (M2, MK19, Javelin, AT4) to engage different enemy targets throughout an engagement area or an area of operations.

g. **Employment as Part of Combined Arms Team.** This is especially important in restrictive terrain. Assets such as TOW, M2, MK19, Javelin, AT4, mines and other obstacles, small arms or machine guns, M203 grenade launchers, and indirect fires must be skillfully blended to achieve the desired effect on the enemy. Antiarmor weapon systems (for example, TOW) alone will not be sufficient. Leaders must position all assets so that rounds impact on the appropriate portions of the enemy formation.

NOTE: Integration of indirect fires into massed direct ATMG fires enhances the effect of a unit's engagements. Mortar and artillery fires can damage TOW wires, causing missiles to miss targets. Leaders must ensure adequate fire control

measures are implemented to prevent indirect fires from falling between the antiarmor unit and the targets during TOW engagements.

E-5. OFFENSIVE OPERATIONS

Antiarmor units seldom provide more than limited support with TOWs to dismounted infantry units attacking through restrictive terrain. The antiarmor units have little chance to reconnoiter beyond the LD, and when employing the TOW they may lack the necessary ranges. However, the TOW can still be used effectively if a careful reconnaissance is performed and if a detailed analysis of the factors of METT-TC allows it.

a. **Attack.** Antiarmor units are most useful when providing direct fire TOW support for a planned attack. They fire missiles at hard targets such as bunkers, weapons emplacements within trench systems, fortified rooms in houses, and dug-in vehicles. See Appendix A, Weapon Reference Data, for round-target selection. Although TOW rounds are less effective than HEAT or high explosive, plastic (HEP) rounds against bunkers, the antiarmor unit's vehicle (HMMWV or ICV) has better mobility in restrictive terrain than a tank. The antiarmor leader (or support force leader) and assault force commander must ensure that signals for ceasing fires and designating targets (for example, AN/PEQ-2A, M203 smoke, various colored star clusters, or infrared chemical lights) are well coordinated before the attack begins.

b. **Armored Enemy.** An armored enemy typically defends from well-prepared vehicle fighting positions that are supported by dug-in infantry. While providing overwatching fire, TOWs must be employed at least 1,000 meters from the enemy armored vehicles to survive. Even then, they can only survive if they surprise the enemy. Directly supporting the infantry attack in restrictive terrain is extremely risky. Other options for TOW employment are--

- Employ TOWs to isolate the enemy in the restrictive terrain, focusing on mounted enemy avenues of approach.
- Protect consolidating infantry or follow-on forces from armor counterattack.

c. **Dismounted Enemy.** A dismounted enemy relies mainly on dug-in infantry (possibly reinforced with dug-in armored vehicles) on terrain that severely inhibits vehicular movement. TOW systems can be used dismounted, which usually makes stealthy occupation of positions easier. Antiarmor units must carry the TOW systems to reach good firing positions, making movement slower and more difficult. Carrying a dismounted TOW system limits an antiarmor section to one system. If an infantry squad is available, its members can carry the extra missiles and provide security; if not, one antiarmor squad in the section carries the extra missiles and provides security.

E-6. DEFENSIVE OPERATIONS

Commanders can use the TOW effectively more often in restrictive terrain during defensive operations than during offensive operations. A defender has more time to conduct a thorough analysis of the factors of METT-TC, to conduct a detailed ground reconnaissance, and to prepare his area of operations.

a. **Integration of Direct and Indirect Fires.** The restrictive terrain prevents the enemy from isolating and concentrating on single defending elements. The most desirable method for destroying enemy formations, even in restrictive terrain, is to integrate the direct fires of all of the available weapons and weapon systems and indirect fires with existing and

reinforcing obstacles. The defender must overwhelm the entire enemy formation throughout an area of operation with direct and indirect fires. However, this must be coordinated and rehearsed. If the defenders fail to mass fires throughout the enemy formation, the enemy can counterattack or suppress individual defending elements.

b. **Enemy Employment of Obscurants.** A mounted enemy will plan to use smoke to conceal his movement across open danger areas or anticipated engagement areas. Although antiarmor units are equipped with thermal sights and can observe and engage through most kinds of smoke, leaders must ensure that accurate range cards are prepared.

c. **Antiarmor Reserves.** Commanders may not find suitable terrain to support company or battalion engagement areas within the battalion's area of operations, or they may find that terrain dictates long, narrow TOW sectors of fire. In either case, antiarmor units employing TOW can be designated as the reserve with several clearly defined missions. For each mission, they move to hasty firing positions to counterattack or block enemy penetrations. Routes and firing positions are prepared and the antiarmor unit rehearses daytime and nighttime occupation. Counterattacks work best when TOW fires are combined with other fires (direct and indirect). Antiarmor units rehearse these missions; they use engineers to reinforce existing natural positions or, at least, to construct hasty vehicle firing positions. If only one good, platoon-sized engagement area exists, commanders can position antiarmor units to cover it with TOW fires.

GLOSSARY

AA	assembly area
AAR	after-action review
ABF	attack by fire
ACE	armored combat earthmover
ADA	air defense artillery
ADAM	area-denial artillery munitions
ADO	air defense officer
ADW	air defense warnings
AFATD	advanced field artillery tactical data system
AGC	advance guard company (graphics only)
AI	area of interest
A/L	administration and logistics
ALO	Air Force liaison officer
AMD	air and missile defense
ANCD	automated net control device
AO	area of operation
AP	antipersonnel
ARFOR	Army forces
ARNG	army national guard
AT	antitank
ATGM	antitank guided missile
ATGM-CM	antitank guided missile countermeasures
ATK POSN	attack position
ATP	ammunition transfer point
ASLT POSN	assault position
AVLB	armored vehicle-launched bridge
AXP	ambulance exchange point
BAS	battalion aid station
BDA	battle damage assessment
BDAR	battle damage assessment and repair
BRDM	Boyevaya Razvedyuatel'naya Dozornaya Meshina (Russian combat reconnaissance patrol vehicle)
BDU	battle dress uniform
BFV	Bradley fighting vehicle
BHL	battle handover line
BMNT	beginning morning nautical twilight
BMP	Russian abbreviation for tracked infantry fighting vehicle (Boyevaya Mashina Pehoti)
BN	battalion
BOS	battlefield operation systems
BP	battle position
BSA	brigade support area
BSB	brigade support battalion

BSC	brigade support company
BSFV	Bradley Stinger fighting vehicle
C2	command and control
CA	civil affairs
CAS	close air support
CASEVAC	casualty evacuation
CBRNE-CM	chemical, biological, radiological, nuclear, and high-yield explosive consequence management
CBU	cluster bomb units
CCIR	commander's critical information requirements
CCP	casualty collection point
CFZ	critical fire zones
CFFZ	critical friendly fire zones
CGP-1	commander's ground pointer (laser pointer)
CMOC	civil military operations center
COA	course of action
COLT	combat observation lasing team
COP	common operational picture
CP	command post; checkpoint
CRT	combat repair team
CS	combat support
CSOP	combat security outpost
CSS	combat service support
CTCP	combat trains command post
DA	Department of the Army
DOD	Department of Defense
DOS	days of supplies
DPICM	dual-purpose improved conventional munitions
DS	direct support
DSO	domestic support operations
DX	direct exchange
DZ	drop zone
EA	engagement area
EAD	echelon above division
ECM	electronic countermeasures
ECOORD	effects coordinator
EEFI	essential elements of friendly information
EENT	end of evening nautical twilight
EFST	essential fire support task
EPW	enemy prisoner of war
ESV	engineer squad vehicle

1SG	first sergeant
FA	field artillery
FAC	forward air controller
FASCAM	families of scatterable mines
FBCB2	force XXI battle command brigade and below
FDC	fire direction center
FEBA	forward edge of battle area
FFIR	friendly forces information requirements
FHA	foreign humanitarian assistance
FID	foreign internal defense
FIST	fire support team
FLIR	forward-looking infrared radar
FLOT	forward line of own troops
FM	frequency modulated; field manual
FO	forward observer
FPP	final protective fire
FPL	final protective line
FRAGO	fragmentary order
FS	fire support
FSB	forward support battalion
FSCoord	fire support coordinator
FSCM	fire support coordination measures
FSE	fire support element
FSO	fire support officer
FSV	fighting support vehicle
GPS	global positioning system
GS	general support
GSR	ground surveillance radar
G/VLLD	ground/vehicle laser locator designator
HC	hexachloroethane
HCA	humanitarian and civic assistance
HE	high explosive
HEAT	high explosive, antitank
HEDP	high explosive, dual purpose
HE-FRAG	high explosive, fragmentation
HEMTT	heavy expanded mobility tactical truck
HEMTT-LHS	heavy expanded mobility tactical truck-load handling system
HEP	high-explosive, plastic
HHC	headquarters and headquarters company
HIMARS	high mobility artillery rocket system
HIMS	HMMWV interchangeable mount systems
HMMWV	high-mobility, multi-purpose wheeled vehicle
HTU	handheld terminal unit

IAW	in accordance with
ICM	improved conventional munitions
ICV	infantry carrier vehicle
INFOSYS	information systems
IPB	intelligence preparation of the battlefield
IR	infrared
IREMBASS	improved remotely monitored battlefield sensor system
ISR	intelligence, surveillance, and reconnaissance
ITOW	improved TOW
IV	inter-visibility
JP8	army common fuel
KIA	killed in action
LD	line of departure
LOGPAC	logistics package
LOS	line of sight
LRP	logistic release point
LVOSS	light vehicle obscuration smoke system
LZ	landing zone
MANPAD	man-portable air defense
MANPADS	man-portable air defense system
MBA	main battle area
MCOO	modified combined obstacle overlay
MDMP	military decision-making process
MEL	maximum engagement line
MEDEVAC	medical evacuation
METT-TC	mission, enemy, terrain, troops and support available, time available and civil considerations
MG	machine gun
MGS	mobile gun system
MIA	missing in action
MICLIC	mine clearing line charge
MICO	military intelligence company
MOE	measures of effectiveness
MOGAS	motor gasoline
MOPMS	modular pack mine system
MOPP	mission-oriented protective posture
MPCOA	most probable course of action
MR	moonrise
MRB	motorized rifle battalion
MRC	motorized rifle company
MRE	meal, ready to eat
MRP	motorized rifle platoon

MS	moon set
MSL	minimum safe line
MSR	main supply route
MTOE	modified table of equipment
NAI	named area of interest
NBC	nuclear, biological, and chemical
NCA	national command authority
NCO	noncommissioned officer
NCS	net control station
NEO	noncombatant evacuation operation
NFA	no fire area
NGO	non-governmental organization
NLT	not later than
NVD	night vision device
OBJ	objective
OAKOC	observation and fields of fire, avenues of approach, key terrain, obstacles, and cover and concealment
OP	observation post
OPCON	operational control
OPORD	operations order
OPSEC	operational security
ORP	objective rally point
OTM	on the move
OTN	own the night
PAO	public affairs officer
PCC	precombat check
PCI	precombat inspection
PIR	priority intelligence requirements
PL	platoon leader; phase line (graphics only)
PLD	probable line of deployment
PLL	prescribed load list
PLS	palletized load system
PLT	platoon
PMCS	preventive maintenance, checks, and services
POL	petroleum, oils, and lubricants
POSNAV	position navigation
PSG	platoon sergeant
PSS	personnel service support
PSYOP	psychological operations
PVO	private volunteer organization
PZ	pickup zone
RAAM	remote antiarmor mine

RATELO	radiotelephone operator
RCPA	relative combat power analysis
REDCON	readiness condition
RCU	remote control unit
RFL	restrictive fire line
ROE	rules of engagement
ROI	rules of interaction
ROM	refuel on the move
RP	release point
RPOL	rearward passage of lines
RROM	refuel/resupply on the move
RSTA	reconnaissance, surveillance, and target acquisition
SA	situation awareness
SAW	squad automatic weapon
SBCT	Stryker brigade combat team
SCATMINE	scatterable mine
SCATMINWARN	scatterable minefield warning
SD	self-destruct
SEAD	suppression of enemy air defenses
SHORAD	short-range air defense
SITREP	situation report
SITEMP	situational template
SOF	special operations forces
SOI	signal operating instructions
SOP	standing operating procedures
SPO	support operations officer
SPOTREP	spot report
SR	sunrise
SS	sunset
SU	situational understanding
TACP	tactical air control party
TLP	troop-leading procedures
TOC	tactical operations center
TOE	table of organization and equipment
TOW	tube-launched, optically tracked, wire-guided (missile)
TRP	target reference point
TSOP	tactical standing operating procedure (graphics only)
UAV	unmanned aerial vehicle
UCMJ	Uniform Code of Military Justice
UMCP	unit maintenance collection point
UN	United Nations

UO	urban operations (replacing term MOUT)
USACE	U S Army Corps of Engineers
VC	vehicle commander
VEESS	vehicle engine exhaust smoke system
WARNO	warning order
WCS	weapons control status
WIA	wounded in action
WP	white phosphorous
WSRO	weapons system replacement operations
XO	executive officer

REFERENCES

DOCUMENTS NEEDED

These documents must be available to the intended users of this publication.

- AR 385-62 Regulations for Firing Guided Missiles and Heavy Rockets for Training, Target Practice and Combat (MCO P3570.2) (Reprinted with Basic Incl C1). 5 January 1977.
- AR 385-63 Policies and Procedures for Firing Ammunition for Training, Target Practice and Combat (MCO P3570.1A). 15 October 1983.
- ARTEP 7-91 Drill Drills for the Antiarmor (TOW) Platoon, Section, and Squad. 03 March 2000.
- DA Form 1155 Witness Statement on Casualty Incident. 1 June 1966.
- DA Form 1156 Casualty Feeder Report. 1 June 1966.
- DA Form 2404 Equipment Inspection and Maintenance Worksheet. 1 April 1979.
- DA Form 5988-E Equipment Inspection Maintenance Worksheet. March 1991.

READINGS RECOMMENDED

These sources contain relevant supplemental information.

- FM 3-25.26 Map Reading and Land Navigation. 20 July 2001.
- FM 3-37.3 (FM 3-5) NBC Decontamination. 28 July 2000.
- FM 3-90 (FM 100-40) Tactics. 4 July 2001.
- FM 5-7-30 (FM 3-34.223) Brigade Engineer and Engineer Company Combat Operations (AB, AA, Light). 38 December 1994.
- FM 5-34 (3-34.310) Engineer Field Data. 30 August 1999.
- FM 5-71-2 (FM 3-34.222) Armored Task Force Engineer Combat Operations. 28 June 1996.
- FM 5-103 (FM 3-34.112) Survivability. 10 June 1985.
- FM 6-30 (FM 3-09.3) Tactics, Techniques and Procedures for Observed Fire Support at Battalion Task Force and Below. 16 July 1991.

FM 7-8 (FM 3-21.8)	Infantry Rifle Platoon and Squad. 22 April 1992.
FM 7-10 (FM 3-21.10)	The Infantry Rifle Company. 14 December 1990.
FM 7-20 (FM 3-21.20)	The Infantry Battalion. 6 April 1992.
FM 7-90 (FM 3-21.90)	Tactical Employment of Mortars. 9 October 1992.
FM 7-98 (FM 3-21.98)	Operations in a Low Intensity Conflict. 10 October 1992.
FM 17-95 (FM 3-20.95)	Calvary Operations. 24 December 1996.
FM 20-32 (FM 3-24.32)	Mine/Countermine Operations. 28 May 1998.
FM 21-76 (FM 3-05.70)	Survival. 5 June 1992.
FM 23-1 (FM 3-22.1)	Bradley Gunnery. 18 March 1996.
FM 23-27 (FM 3-22.27)	MK-19, 40 MM Grenade Machine Gun, MOD 3. 27 December 1988.
FM 23-34 (FM 3-22.34)	TOW Weapon Systems. 17 August 1994.
FM 23-65 (FM 3-22.65)	Browning Machine Gun Caliber .50 HB, M2. 19 June 1991.
FM 27-10 (FM 1-04.10)	The Law of Land Warfare. 18 July 1950, Change 1, 15 July 1976.
FM 71-1 (FM 3-90.1)	Tank and Mechanized Infantry Company Team. 26 January 1998.
FM 90-4 (FM 3-18.12)	Air Assault Operations. 16 March 1987.
FM 90-7 (FM 3-34.1)	Combined Arms Obstacle Integration. 29 September 1994.
FM 90-10 (FM 3-97.10)	Military Operations on Urbanized Terrain (MOUT) (How to Fight). 15 August 1979.
FM 90-10-1 (FM 3-06.11)	An Infantryman's Guide to Combat in Built-up Areas. 12 May 1993.
FM 90-13-1 (FM 3-34.2)	Combined Arms Breaching Operations (Reprinted with Basic Incl C1). 28 February 1991.
FM 100-5 (FM 3-0)	Operations. 14 June 1993.

- FM 100-14 (FM 5-19) Risk Management. 23 April 1998.
- FM 100-19 (FM 3-07.7) Domestic Support Operations (FM 7-10). 01 July 1993.
- FM 100-20 (FM 3-07) Military Operations in Low Intensity Conflict. 05 December 1990.
- FM 100-23 (FM 3-07.3) Peace Operations. 30 December 1994.
- FM 101-5 (FM 5-0) Army Planning and Orders Preparation. 31 May 1990.
- FM 101-5-1 (FM 1-02) Operational Terms and Symbols. 21 October 1985.
- GTA 05-08-001 Survivability Positions. 1 August 1993.
- GTA 07-06-001 Fighting Position Construction Infantry Leaders Reference Card. 1 June 1992.
- JOINT PUB 3-07.2 Joint Tactics, Techniques, and Procedures for Antiterrorism. 17 March 1998.
- JOINT PUB 3-07.3 Joint Tactics, Techniques, and Procedures for Peace Operations. 12 February 1999.

INTERNET SOURCES USED

Army Doctrine and Training Digital Library, <http://www.adtdl.army.mil>

U.S. Army Publishing Agency, <http://www.usapa.army.mil>

INDEX

- actions on contact, 4-10
 - convoy escort, in, 8-22
 - development, 4-11
 - four steps of, 4-11
 - time requirements, 4-11
 - urban operations, in 6-25
- active protection systems, 1-12
 - ATGM jammers, 1-13
 - laser warning receivers, 1-13
 - hard kill systems, 1-13
- ADAM, 10-27
- air defense, 4-3
 - defensive operations, 5-7
 - early warning procedures, 10-33
 - employment, in CS, 10-33
 - machine gun aiming points, 10-35 (illus)
 - passage of lines, 7-15
 - reaction procedures, 10-34
 - systems, in CS, 10-31, 10-32 (illus)
 - urban operations, 6-22
 - weapons control status, 10-33
- ambush (see also attack), 4-10
 - actions, convoy escort, 8-22
 - antiarmor position, D-10
- approach-march technique, 4-23
- assembly area, in offense, 4-4
- assault, 4-5
 - defensive operations, 5-4
 - offensive operations, 4-5
- attack, 4-14
 - ambush, 4-19
 - characteristics of, 4-14
 - checklist for, 10-22 (illus)
 - close combat, in CS, 10-22
 - counterattack, 4-21
 - deliberate, 4-17
 - demonstration, 4-22
 - direction of assault, 6-15 (illus)
 - feint, 4-22
 - hasty, 4-16
 - isolating objective, 6-15 (illus)
 - options, 4-19
 - raid, 4-19
 - spoiling, 4-20
 - TOW, in restrictive terrain, E-4
 - types of, 4-14
 - UO, in, 6-14
- audacity, in offensive operations, 4-2
- Avenger, 10-31, 10-32 (illus)
- avenue of approach, 2-12
 - analysis, in TLP, 2-12
 - identifying, in defensive operations, 5-25
 - urban operations, in, 6-20
- battle drill, in actions on contact, 4-12
- battle operating systems, 4-2
 - air defense, 4-3
 - combat service support, 4-3
 - fire support, 4-2
 - mobility and survivability, 4-3
 - planning considerations in defensive operations, 5-4
- bounding, 3-10
 - alternate bounds, 3-11
 - forces, movement in maneuver, 4-10
 - overwatch, 3-10 (illus)
 - successive bounds, 3-11
- Bradley Linebacker, 10-31, 10-21 (illus)
- Bradley Stinger Fighting Vehicle, 10-31, 10-32 (illus)
- breaching, in CS, 10-23
 - key doctrine, 10-24 (illus)
- camouflage during movement, 3-2
- capabilities and limitations, 1-9
 - additional capabilities 1-9
 - defensive, 1-9
 - limitations, 1-10
 - offensive, 1-9
- casualty report, 11-17 (illus)
- checkpoints, in stability operations, 8-16
 - layout, 8-18 (illus)
 - purpose, 8-16
- civil considerations, analysis in TLP, 2-20
 - urban operations, analysis in, 6-10, 6-24
- close air support (see also combat support), 10-18
 - AC-130 gunship, 10-19

- battle damage assessment format,
 - 10-19 (illus)
 - marking friendly positions, 10-19, 10-20 (illus)
- combat service support, 11-1
 - BOS, 4-3
 - considerations in stability operations, 8-9
 - defensive operations, in, 5-11
 - development of plan, 11-1
 - health service support, 11-13
 - maintenance operations, 11-11
 - reorganization and weapons replacement, 11-18
 - responsibilities, 11-2
 - in passage of lines, 7-15
 - resupply, 11-5
 - antiarmor resupply requirements, 11-11
 - classes of supply, 11-5
 - LOGPAC, 11-10
 - prestock operations, 11-10
 - trains, 11-4
 - SBCT and, 11-19
- combat support, 10-1
 - air defense artillery, 10-31
 - close air support, 10-18
 - command and support relationship, 10-1
 - direct support, 10-2
 - general support, 10-2
 - fire support, 10-7
 - fire support preparation, 10-7
 - final protective fires, 10-14
 - fire support team, 10-18
 - munitions, special, 10-15
 - targets, 10-13
 - helicopter attack, 10-21
 - intelligence, 10-22
 - maneuver support, 10-23
 - NBC support, 10-30
 - SBCT, and, 10-36
- command and control, 2-1
 - battle command, in urban operations, 6-5
 - C2 system, 2-1
 - concept of, 2-2
 - convoy escort, in, 8-20
 - definitions, 2-1
 - fundamentals of, 2-2
 - leadership, 2-2
 - passage of lines, in, 7-15
 - responsibilities, 2-3
 - company commander, 2-3
 - executive officer, 2-3
 - first sergeant, 2-4
 - platoon leader, 2-4
 - section leader, 2-4
 - squad leader, 2-4
 - consolidation and reorganization, 4-5
 - defensive operations, in, 5-4
 - offensive operations, in, 4-5
 - urban operations, in, 6-16
 - convoy escort in stability operations, 8-19
 - C2, 8-20
 - task-organized mission, 8-20 (illus)
 - counterattack, 4-20
 - attack option, 4-20
 - defensive operations, in, 5-4
 - offense, 4-20
 - urban operations, in, 6-25
 - countermobility in CS, 10-24
 - mine dump operations, 10-25
 - obstacle intent, 10-25
 - obstacle planning, 10-25
- course of action, 2-22
 - actions on contact, in, 4-11, 4-13
 - analyze, in TLP, 2-24
 - array initial forces, in TLP, 2-24
 - assign headquarters, 2-24
 - commander's critical information requirements, 2-26
 - compare and select, 2-26
 - development of, in TLP, 2-22
 - relative combat power analysis matrix, 2-22, 2-23 (illus)
 - schemes of maneuver, in TLP, 2-24
 - statements and sketches, 2-24
 - war gaming, in TLP, 2-25
- cover and concealment, 1-7
 - analysis of, in TLP, 2-15

- considerations in analysis, 2-15
 - (illus)
 - TOW, in restricted terrain, E-3
 - weapons placement, in defensive operations, 5-6
- defensive operations, 5-1
 - air defense, 5-8
 - BOS planning, 5-5
 - characteristics of, 5-1
 - control measures, 5-12
 - CSS in, 5-11
 - defend from battle position, 5-15, 5-16 (illus), 5-17 (illus), 5-18 (illus)
 - defend in sector, 5-13, 5-14 (illus)
 - multiple engagement areas, 5-18, 5-19 (illus)
 - other employment options, 5-22
 - priority of work, 5-32
 - purpose, 5-1
 - reverse slope, 5-19, 5-20 (illus)
 - sector sketches, 5-34
 - selection considerations, 5-13 (illus)
 - sequence of, 5-3
 - techniques, 5-12
- demonstration, see attack
- deployment in offensive operations, 4-4
- doctrine, 1-1
 - base of fire or fixing force, 1-1
- employment, 1-4
 - combined-arms team, 1-8
 - cover and concealment, 1-6
 - flank engagements, 1-5
 - fundamentals, 1-4
 - in depth, 1-8
 - mutual support, 1-4
 - security, 1-5
 - stand off, 1-5
- enabling operations, tactical, 7-1
 - guard, 7-8
 - linkup, 7-12
 - local security, 7-11
 - passage of lines, 7-14
 - reconnaissance, 7-1
 - screen, 7-6
 - security, 7-2
- enemy, 2-16
 - assault, 5-4
 - avenue of approach, identification, in defensive operations, 5-25, 5-26 (illus)
 - counterattack, 5-4
 - main attack, 5-4
 - movement to contact, considerations of, 4-23
 - preparatory fires, in the defense, 5-3
 - scheme of maneuver, in defensive operations, 5-26, 5-27 (illus)
 - security operations, consideration of, 7-3
 - TLP, analysis, 2-16
 - urban operations, analysis of 6-8, 6-17
 - where to kill, in defensive operations, 5-27, 5-29 (illus)
- enemy countermeasures, 1-10
 - before TOW gunner fires, 1-10
 - camouflage, 3-2
 - deception, 1-11
 - reduce TOW effectiveness, 1-13
 - while TOW in flight, 1-10
- engagement area, multiple, in defensive operations, 5-18, 5-19 (illus) 5-31
- development, in defensive operations, 5-25
- envelopment, in offensive operations, 4-6, 4-7 (illus)
- rehearsal, in defensive operations,
- feint (see attack), 4-21
- field artillery and the SBCT, in CS, 10-36
- fighting positions, D-12
 - initial, in urban operations, 6-23
 - M2, M19 positions, D-17, D-18 (illus)
 - principles, D-13
 - priority of work, D-13
 - stages, D-13
 - stage 1, D-14 (illus)
 - stage 2, D-15 (illus)
 - stage 3, D-16 (illus)

- stage 4, D-17 (illus)
- standard designs, D-12
- three-soldier position, D-19, D-20 (illus)
- fire support, 4-2
 - BOS, 4-2
 - considerations, in CS, 10-2, 10-3 (illus)
 - direct, in urban operations, 6-5
 - execution matrix, 10-9, 109-10 (illus)
 - indirect, planning in security operations, 7-5
 - planning, in CS 10-4
 - special munitions, in CS, 10-15
 - urban operations defense, 6-22
- fires, suppressive, during movement, 3-2
 - commands, C-20
 - common fire control measures, C-10 (illus)
 - direct and indirect, weapons placement, 5-6
 - direct fire planning, C-8
 - direct, in linkup, 7-12
 - enemy, preparatory, in defensive operations, 5-3
 - friendly-based quadrants, C-13 (illus)
 - indirect fire planning, C-9
 - indirect, in close support, in CS, 10-17
 - indirect, in linkup, 7-12
 - indirect, planning and integrating, defensive operations, 5-30, 5-31 (illus)
 - patterns, C-15 (illus)
 - planning and control, C-1
 - process, C-3, C-4 (illus), C-5 (illus), C-6 (illus), C-7 (illus)
 - support, in defensive operations, 5-7
 - target array, C-16 (illus)
- firing positions, D-1
 - alternate, D-2(illus)
 - occupation, D-5
 - ground clearance, D-11 (illus)
 - preparation, D-4, D-5 (illus)
 - primary, D-2 (illus)
 - reconnaissance, D-4
 - subsequent, D-3, D-4 (illus)
 - supplementary, D-3 (illus)
 - types of positions, D-6
 - excavated hull-down, D-7 (illus)
 - hide position to hull-down, D-8 (illus)
 - natural hull down, D-6 (illus)
 - outline of dismounted position, D-9 (illus)
 - overhead cover and missile guidance set position, D-10 (illus)
- force protection, in stability operations, 8-8
- foreign internal defense, see also stability operations, 8-4
- formations, 3-2
 - coil and herringbone, 3-7, 3-8 (illus)
 - column, 3-2, 3-3 (illus)
 - echelon, 3-4, 3-5 (illus)
 - line, 3-3, 3-4 (illus)
 - vee, 3-6, 3-7 (illus)
 - wedge, 3-5, 3-6 (illus)
- fratricide, B-1
 - checklist, B-10 (illus)
 - consideration, B-9
 - reduction measures, B-8
 - risk management, and, B-6
- graphic controls, in urban operations, 6-6 (illus), 6-11, 6-12 (illus), 6-25
- hasty defense, in urban operations, 6-26
- health service support, 11-11
- humanitarian and civil assistance, see also stability operations, 8-5
- intelligence, in CS, 10-22
 - military intelligence and the SBCT in CS, 10-36
- linkup, 7-12
 - contingency, 7-13
 - planning, 7-12
 - steps in, 7-13 (illus)
- lodgment area, 8-10
 - general layout, 8-12

- long-term occupation, 8-11
- use of existing facilities, 8-11 (illus)
- LOGPAC, 11-7
- maintenance operations, 11-11
- maneuver, 2-24
 - BOS and, in defensive operations, 5-5
 - cover and concealment, 5-6
 - depth and dispersion, 5-5
 - direct fire suppression, 5-6
 - disengagement criteria, 5-6
 - displacement planning, 5-5
 - employment on battlefield, 4-9
 - envelopment, in offensive operations, 4-6, 4-7 (illus)
 - flank position, 5-5
 - forms of, offensive operations, 4-5
 - frontal attack, in offensive operations, 4-8
 - infiltration, in offensive operations, 4-8, 4-9 (illus), 4-29 (illus), 4-30 (illus)
 - offensive, in sequence, 4-4
 - penetration, in offensive operations, 4-5, 4-6 (illus)
 - scheme of, develop in TLP, 2-24
 - SOP, in actions in contact, 4-12
 - support, in CS, 1023
 - turning, in offensive operations, 4-7, 4-8 (illus)
 - urban operations, in, 6-7
 - weapons placement and, 5-5
- MANPADS, 10-31, 10-32 (illus)
- METT-TC, 1-1
 - analysis of terrain matrix, 2-11 (illus)
 - civil considerations, analysis of in TLP, 2-20
 - analysis of, in urban operations, 6-10, 6-24
 - employment, 1-1
 - enemy analysis, in TLP, 2-16
 - time, analysis of in TLP, 2-19
 - TLP and MDMP, 2-8
 - troops, analysis of in TLP, 2-19
 - weather analysis, 2-15
 - urban operations, analysis of, 6-8, 6-17
- military decision-making process, see MDMP, 2-5
- mines, 10-26
 - dump operations, 10-25
 - multiple delivery system, 10-27
 - SCATMINE delivery systems, 10-27
 - SCATMINE emplacement authority, 10-26 (illus)
 - SCATMINE marking, 10-28, 10-29 (illus)
 - SCATMINE safety and fragment hazard zones, 10-30 (illus)
 - scatterable mine field warning, 10-26, 10-27 (illus)
 - scatterable mines, 10-26
- mobility, in CS, 10-23
 - breaching doctrine, 10-24 (illus)
 - breaching operations, 10-23
 - planning, in the defense, 10-24
 - route clearance, 10-24
- mobility and survivability, as BOS, 4-3
 - in defensive operations, 5-8
- MOPMS, 10-27
- movement, 2-26
 - bounding force, 4-10
 - contact, to, 4-22
 - formations, 3-2
 - fundamentals of, 3-1
 - initiate, in TLP, 2-26
 - line of departure in offense, to, 4-4
 - techniques of, 3-9
 - urban operations, in, 6-4, 6-13
- multiple delivery mine system, 10-27
- NBC support, in CS, 10-30
- noncombatant evacuation operations, see also stability operations, 8-6
- OAKOC, 2-10
 - avenue of approach, in TLP, 2-12
 - cover and concealment, 2-15 (illus)
 - observation and fields of fire, 2-14, 2-15 (illus)
- organization, 1-1
 - Airborne and air assault battalion, in, 1-2

- light infantry brigade, in, 1-3
- TOE, 1-2 (illus)
- obstacles, 2-11, 2-12 (illus)
- SBCT, in 1-3
- TLP, and, 2-10, 2-11 (illus)
- observation posts, 8-15, 8-16 (illus)
- obstacles, 2-11
 - actions at, in convoy escort, 8-23
 - barrier, resupply material, 10-25
 - intent, in CS, 10-25
 - lanes of, in defensive operations, 5-11
 - passage of lines, in, 7-15
 - planning and integration, in
 - defensive operations, 5-29, 5-30 (illus)
 - planning, in CS, 10-25
 - protective, in defensive operations, 5-10
 - tactical, in defensive operations, 5-9, 5-10 (illus)
 - TLP, and, 2-11, 2-12 (illus)
 - urban operations, in, 6-19, 6-20 (illus)
 - wire, in defensive operations, 5-11 (illus)
- offense, 4-1
 - actions on contact, 4-10
 - four steps of, 4-11
 - attack, 4-14
 - base-of-fire force, 4-9
 - bounding force, 4-10
 - characteristics, 4-1
 - exploitation, 4-31
 - maneuver, forms of, 4-5
 - movement to contact, 4-22
 - purpose, 4-1
 - pursuit, 4-31
 - sequence of, 4-4
 - types of, 4-14
- orders, 2-4
 - combat, 2-4
 - brevity and clarity, 2-4
 - operations, 2-7
 - constraints, 2-9
 - higher headquarters, 2-8
 - issue, during TLP, 2-27
 - repeated mission statement, 2-9
 - TLP, in, 2-7
 - unit mission, 2-8
 - tailoring, 2-5
 - warning, in TLP, 2-6
 - issuing, in TLP, 2-22
- OPORD, see troop-leading procedures and see orders
- passage of lines, 7-14
 - forward passage of lines, 7-16, 7-17 (illus)
 - planning, 7-15
 - rearward passage of lines, 7-17, 7-18 (illus)
 - reconnaissance in, 7-15
 - tactical enabling operations, in, 7-14
- patrol operations, see also stability operations, 8-19
- peace operations, 8-3
 - diplomatic efforts, in support of, 8-4
 - peace enforcement, 8-3
 - peacekeeping, 8-3
 - stability operations, inc, 8-3
- penetration, in offensive operations, 4-5, 4-6 (illus)
- priority of fire, in urban operations, in the defense of, 6-22
- RAAM, 10-27
- raid, see also attack, 4-19
- raptor/hornet, 10-27, 10-28(illus)
- reconnaissance, 1-11
 - conduct of, during TLP, 2-27
 - defensive operations, in, 5-3
 - enemy countermeasures, 1-11
 - firing position preparation, in, D-4
 - NBC, in, in CS support, 10-31
 - offensive operations, in, 4-4
 - passage of lines, in, 7-15
 - reconnaissance platoon and the SBCT, in CS, 10-31
 - tactical enabling operations, in, 7-1
 - urban operations, in, 6-28
- remote antiarmor mine, see RAAM, 10-27
- replacement, 11-18

- equipment, 11-19
- personnel, in CSS, 11-18
- weapons, 11-18
- reserve, 5-24
 - defensive operations, in, 5-24
 - stability operations, in, 8-24
 - urban operations, in, 6-23
- resupply, 11-7
 - avenue of approach requirements, 11-11
 - emergency, 11-10
 - LOGPAC, 11-7
 - methods, 11-8
 - prestock, 11-10
- risk, B1 through B-11
 - assessment of, during TLP, 2-21
 - levels and impact on mission, B-3 (illus)
 - management of, B-1 (illus)
 - potential hazards, B-2 (illus)
 - worksheet, B-4 (illus)
- ROE, in stability operations, 8-7
- ROI, in stability operations, 8-9
- RSTA and the SBCT, in CS, 10-37
- search-and-attack, 4-25
 - concept sketch, 4-30 (illus)
 - in movement to contact, 4-25
- security, 5-3
 - defense of block or group of buildings, in urban operations, 6-28
 - defensive operations, in, 5-3
 - establish, in urban operations, 6-23
 - local, in enabling operations, 7-11
 - stability operations, in, 8-2
 - TOW, in restrictive terrain, E-3
- security assistance, see also stability operations, 8-5
- security force, 5-22
 - defensive operations, in, 5-22
 - fighters, 5-23
 - finders, 5-23
- service station resupply, see also combat service support, 11-8, 11-9 (illus)
- SHORAD, 10-33
 - short-range air defense, see SHORAD, 10-33
- smoke and obscurants, 1-11
 - combat support, in, 10-6
 - enemy countermeasures, 1-11
 - movement, use during, 3-2
 - NBC, in, in CS, 10-30
 - on-board obscurants, 1-12
 - smoke grenade launchers, 1-12
 - urban operations, in, 6-5
 - vehicle engine exhaust smoke system, 1-12
- snipers and the SBCT in CS, 10-27
- spoiling attack, see also attack, 4-20
- stability operations, 8-1
 - arms control, 8-7
 - checkpoints, establishment, 8-16
 - combat service support, 8-9
 - convoy escort, 8-19, 8-20 (illus)
 - employment of checkpoints, OPs, and patrols, zone of separation, 8-19 (illus)
 - foreign internal defense, 8-4
 - humanitarian and civic assistance, 8-5
 - lodgment areas, 8-10
 - media considerations, 8-9
 - negotiations, 8-13
 - noncombatant evacuation operations, 8-6
 - observation posts, establishment, 8-15
 - patrol operations, 8-19
 - peace operations, 8-3
 - principles, 8-1
 - security assistance, 8-5
 - support to insurgencies, 8-5
 - terrorism, combatting, 8-5
- support to insurgencies, see also stability operations, 8-5
- support operations, 9-1 through 9-6
- surprise, during offense, 4-1
- tailgate resupply, 11-9, 11-10 (illus)
- tempo, during defense, 4-2
- terrain, 2-13
 - analysis of, in TLP, 2-13

- key, defense of, in urban operations, 6-29, 6-30 (illus)
- key terrain, 2-13, 2-14 (illus)
- urban operations, in, 6-9, 6-18, 6-20
- use of, during movement, 3-1
- terrorism, 8-5
 - antiterrorism, 8-6
 - counterterrorism, 8-6
 - stability operations, in, 8-5
- time, analysis of, in TLP, 2-19
 - urban operations, analysis in, 6-23
- timeline, company, 2-20 (illus)
- TOW, A-1 through A-3
 - characteristics of, A-3 (illus)
 - employment in restrictive terrain, see appendix E
 - M2, A-2
 - missile types, A-2 (illus)
 - MK 19, A-2
 - probability of survival, D-1 (illus)
- trains, see also combat service support, in CSS, 11-4
- troop-leading procedures, 2-5 through 2-28
 - application of, 2-5
 - CCIR, 2-26
 - commander's intent, 2-20
 - complete the plan, 2-27
 - courses of action, 2-22
 - enemy, analysis of, 2-16
 - issue OPORD, 2-27
 - MDMP, and, 2-5
 - mission analysis, 2-7
 - OPORDS, in, 2-7
 - reconnaissance during TLP, 2-27
 - risk assessment, 2-21
 - supervise and refine, 2-28
 - terrain and weather analysis, 2-9
 - time, analysis of, 2-19
 - troops, analysis of, 2-19
 - using OAKOC, 2-10
 - war games, in COA analysis, 2-25
 - WARNOs in, 2-6
 - INFOSYS, and, 2-6
- traveling, as movement technique, 3-9 (illus)
- traveling overwatch, as movement technique, 3-10 (illus)
- troops, 2-19
 - analysis of, in TLP, 2-19
 - availability, in urban operations, 6-10
 - requirements, in urban operations, 6-7
- turning, in offensive operations, 4-7, 4-8 (illus)
- urban operations, 6-1 through 6-31
 - antiarmor firing positions in, D-10
 - command and control in, 6-25
 - defend block or group of buildings, 6-28
 - defense in UO, 6-17
 - defense of village, 6-27
 - employment considerations, 6-1
 - employment of antiarmor vehicles, 6-2
 - hasty defense, 6-26
 - isolate objective, 6-14 (illus), 6-15 (illus)
 - movement in, 6-13
 - offense, in UO, 6-7
- visibility, 3-1
 - limited, defense during, in UO, 6-25
 - limited, use during movement, 3-1
- Volcano, 10-27
- WARNO, see troop-leading procedures, see orders
- weather, analysis of, in TLP, 2-16
- weapons, 5-5
 - direct fire planning and control, C-1 through C-21
 - direct fire, in UO, 6-16
 - emplacement, in defensive operations, 5-28, 5-29 (illus)
 - engagement matrix, 5-35 (illus)
 - placement, in defensive operations, 5-5
 - replacement, 11-18, 11-19
 - sector sketches, in UO, 5-34
 - weapon reference data, A-1 through A-3
 - weapons control status, 10-23

weapons safety posture levels, C-18
(illus)
witness statement, 11-18 (illus)

FM 3-21.91 (FM 7-91)
26 NOVEMBER 2002

By Order of the Secretary of the Army:

ERIC K. SHINSEKI
General, United States Army
Chief of Staff

Official:



JOEL B. HUDSON
Administrative Assistant to the
Secretary of the Army
0232901

DISTRIBUTION:

Active Army, Army National Guard, and U. S. Army Reserve: To be distributed in accordance with initial distribution number 110802, requirements for FM 3-21.91.

PIN: 080494-000